

möbel
C a b i n e t r y

THE SPEC BOOK

SPECIES

SPECIES

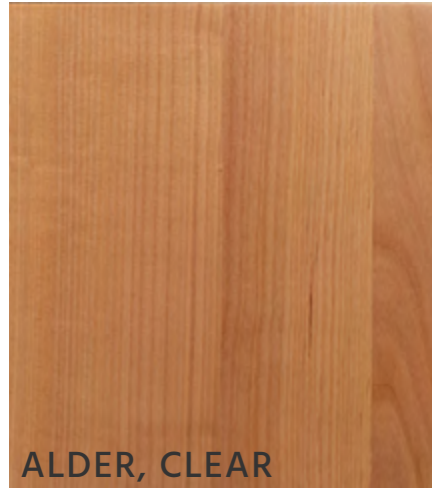

ALDER, CLEAR

VENEER MATERIAL AVAILABILITY:
-Solid & Veneer material available.

CABINET CONSTRUCTION:
-5/8"Th & 3/4"Th available.

FINISHED ENDS:
-Available.

SOLID WOOD COMPONENTS:
-Select Door Styles & Accessories available.

VENEERED COMPONENTS:
-Available.

PANEL SIZE AVAILABILITY:

- 5/8"Th 48"W x 96"H Vertical Grain (2-Sided & 1-Sided).
- 3/4"Th 48"W x 96"H Vertical Grain (2-Sided & 1-Sided).
- Larger sizes & horizontal grain may be available upon request.

SPECIES CODE:
-ALDC



ALDER, KNOTTY

DESCRIPTION:

- Includes multiple knots & mineral streaks. Knots range from open & closed.

CABINET CONSTRUCTION:
-5/8"Th & 3/4"Th available.

FINISHED ENDS:
-Available.

SOLID WOOD COMPONENTS:
-Doors available with solid wood centre panels only.
-Some accessories will only be available in Clear Alder.

VENEERED COMPONENTS:
-Veneer compones available with closed knots only.

PANEL SIZE AVAILABILITY:

- 5/8"Th 48"W x 96"H Vertical Grain (2-Sided & 1-Sided).
- 3/4"Th 48"W x 96"H Vertical Grain (2-Sided & 1-Sided).
- Larger sizes & horizontal grain may be available upon request.

SPECIES CODE:
-ALDK

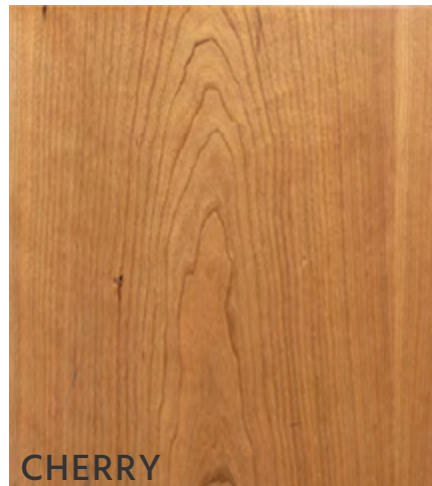

CHERRY

CABINET CONSTRUCTION:
-5/8"Th & 3/4"Th available.

FINISHED ENDS:
-Available.

SOLID WOOD COMPONENTS:
-Select Door Styles & Accessories available.

VENEERED COMPONENTS:
-Available.

PANEL SIZE AVAILABILITY:

- 5/8"Th 48"W x 96"H Vertical Grain (2-Sided & 1-Sided).
- 3/4"Th 48"W x 96"H Vertical Grain (2-Sided & 1-Sided).
- Larger sizes & horizontal grain may be available upon request.

SPECIES CODE:
-CH



LAMINATE

CABINET CONSTRUCTION:
-5/8"Th & 3/4"Th available.

-Open Shelf & Cabinets with Finished interiors will be constructed with 3/4"Th 2-Sided Laminate.

FINISHED ENDS:

- Overlay Panels recommended.
- If a Finished End is ordered, 3/4"Th 2-Sided material will be used in place of the gable regardless of cabinet construction. The inside of the gable will match the exterior & not the interior.

SOLID COMPONENTS:
-Not available.

VENEERED COMPONENTS:
-3/4"Th 2-Sided material only.

PANEL SIZE AVAILABILITY:

- 3/4"Th 2-Sided material only.
- Width & Height will vary by finish.
- Laminate available by special request.

SPECIES CODE:
-LAM

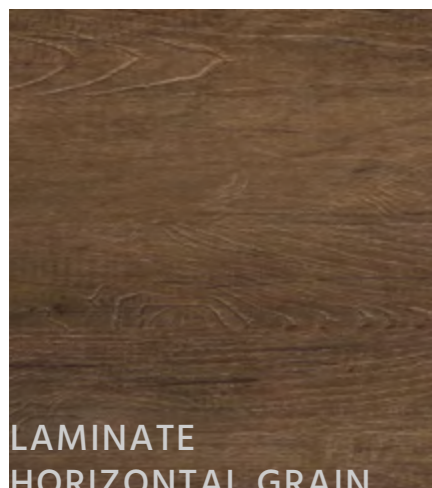

LAMINATE HORIZONTAL GRAIN

CABINET CONSTRUCTION:
-5/8"Th & 3/4"Th available.
-Open Shelf & Cabinets with Finished Interiors will be constructed with 3/4"Th 2-Sided Laminate. Maximum recommended hight: 48"H.

FINISHED ENDS:

- Not available on cabinets over 48"H due to sheet good limitations. Overlay Panels strongly recommended.
- If a Finished End is ordered, 3/4"Th 2-Sided material will be used

in place of the gable regardless of cabinet construction. The inside of the gable will match the exterior & not the interior.

SOLID COMPONENTS:
-Not available.

VENEERED COMPONENTS:
-3/4"Th 2-Sided material only.

PANEL SIZE AVAILABILITY:

- 3/4"Th 2-Sided material only.
- Width & Height will vary by finish.
- Laminate available by special request.

SPECIES CODE:
-LAM

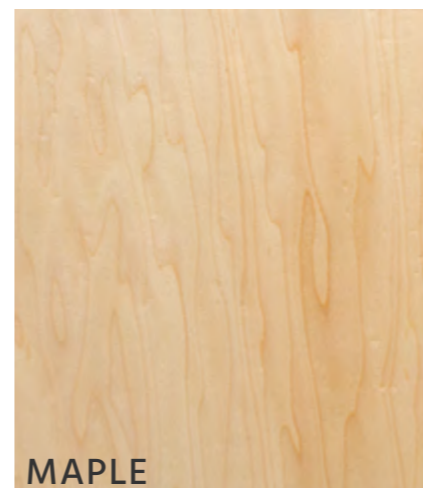

MAPLE

CABINET CONSTRUCTION:
-5/8"Th & 3/4"Th available.

FINISHED ENDS:
-Available.

SOLID WOOD COMPONENTS:
-Select Door Styles & Accessories available.

VENEERED COMPONENTS:
-Available.

PANEL SIZE AVAILABILITY:

- 5/8"Th 48"W x 96"H Vertical Grain (2-Sided & 1-Sided).
- 3/4"Th 48"W x 96"H Vertical Grain (2-Sided & 1-Sided).
- Larger sizes & horizontal grain may be available upon request.

SPECIES CODE:
-MA

SPECIES

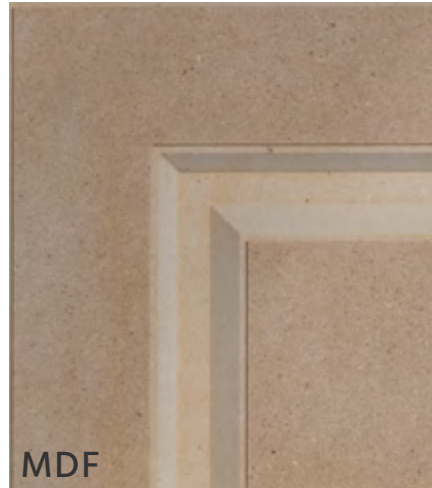

MDF

CABINET CONSTRUCTION:
-5/8"Th & 3/4"Th available.

MATERIAL AVAILABILITY:
-Solid MDF & Paint Grade veneer material available.
-Paint Grade wood will be used when solid MDF accessories are not available.

FINISHED ENDS:
-Available.
-Overlay panels are recommended for Plywood construction.

SOLID MDF COMPONENTS:
-Paint Grade wood will automatically be substituted when MDF is not available.

VENEERED COMPONENTS:
-Available. Solid MDF panels will be used where possible.

PANEL SIZE AVAILABILITY:
-3/4"Th 48" x 96" (2-Sided & 1-Sided).
-Larger sizes may be available upon request.

SPECIES CODE:
-MDF

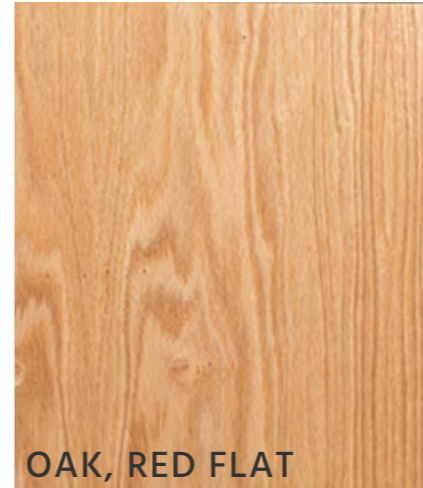

OAK, RED FLAT

DESCRIPTION:
-Flat Cut Red Oak.

CABINET CONSTRUCTION:
-5/8"Th & 3/4"Th available.

FINISHED ENDS:
-Available.

SOLID WOOD COMPONENTS:
-Select Door Styles & Accessories available.

VENEERED COMPONENTS:
-Available.

PANEL SIZE AVAILABILITY:
-5/8"Th 48"W x 96"H Vertical Grain (2-Sided & 1-Sided).
-3/4"Th 48"W x 96"H Vertical Grain (2-Sided & 1-Sided).
-Larger sizes & horizontal grain may be available upon request.

SPECIES CODE:
-OAK



OAK, WHITE FLAT

DESCRIPTION:
-Flat Cut White Oak.

CABINET CONSTRUCTION:
-5/8"Th & 3/4"Th available.

FINISHED ENDS:
-Available.

SOLID WOOD COMPONENTS:
-Select Door Styles & Accessories available.

VENEERED COMPONENTS:
-Available.

PANEL SIZE AVAILABILITY:
-5/8"Th 48"W x 96"H Vertical Grain (2-Sided & 1-Sided).
-3/4"Th 48"W x 96"H Vertical Grain (2-Sided & 1-Sided).
-Larger sizes & horizontal grain may be available upon request.

SPECIES CODE:
-OAKWF



OAK, WHITE RIFT

DESCRIPTION:
-Rift Cut White Oak.

CABINET CONSTRUCTION:
-5/8"Th & 3/4"Th available.

FINISHED ENDS:
-Available.

SOLID WOOD COMPONENTS:
-Select Door Styles & Accessories available.
-For some carved components, Flat White Oak may be a suggested alternative.

VENEERED COMPONENTS:
-Available.

PANEL SIZE AVAILABILITY:
-5/8"Th 48"W x 96"H Vertical Grain (2-Sided & 1-Sided).
-3/4"Th 48"W x 96"H Vertical Grain (2-Sided & 1-Sided).
-Larger sizes & horizontal grain may be available upon request.

SPECIES CODE:
-OAWR



P.E.T.

CABINET CONSTRUCTION:
-5/8"Th & 3/4"Th available.
-Open Shelf & Cabinets with Finished interiors will be constructed with 18mm Th 2-Sided P.E.T..

FINISHED ENDS:
-Overlay Panels recommended.
-If a Finished End is ordered, 18mm Th 2-Sided P.E.T. will be used in place of the gable regardless of cabinet construction. The inside of the gable will match the exterior & not the interior.

SOLID COMPONENTS:
-Not available.

VENEERED COMPONENTS:
-18mm Th 2-Sided P.E.T. material only.

PANEL SIZE AVAILABILITY:
-18mm Th 48"W x 110"H (2-Sided).

SPECIES CODE:
-PET



WALNUT

CABINET CONSTRUCTION:
-5/8"Th & 3/4"Th available.

FINISHED ENDS:
-Available.

SOLID WOOD COMPONENTS:
-Select Door Styles & Accessories available.

VENEERED COMPONENTS:
-Available.

PANEL SIZE AVAILABILITY:
-5/8"Th 48"W x 96"H Vertical Grain (2-Sided & 1-Sided).
-3/4"Th 48"W x 96"H Vertical Grain (2-Sided & 1-Sided).
-Larger sizes & horizontal grain may be available upon request.

SPECIES CODE:
-WA



DOOR STYLES

WOOD DOORS

WOOD DOORS

ALBAN WOOD DOOR:



WALNUT CABERNET

DOOR STYLE SPECIFICATIONS:

DOOR CONSTRUCTION:

- 5 Piece Wood Door with Raised Centre Panel.

MINIMUM SIZE:

- 9"W x 9"H.

- Smaller sizes will be manufactured with reduced rails or be Slab.

- Subject to cabinet minimums.

MAXIMUM SIZE:

- 24"W x 48"H.

- Larger doors will have cross rails. Cross Rails can be removed at no charge but will void warranty.

GLASS DOORS:

- 1LITE Frame only.

- Mullions not available.

WAINSCOT PANELS:

- Available.

DOOR MATCH FILLERS/PILASTERS:

- Available.

- Minimum width: 3 1/2"W.

- Centre panel will be flat veneer.

COMPLIMENTARY DOOR STYLES:

- STERLING

SPECIES AVAILABLE:

- Alder, Clear
- Alder Knotty
- Cherry
- Maple
- Oak, Red Flat
- Oak, White Flat
- Oak, White Rift
- Walnut

DOOR PROFILE:

DOOR PROFILE

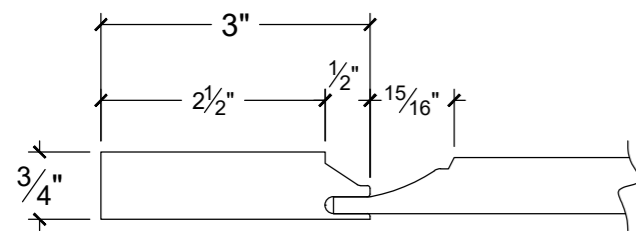

CROSS RAIL PROFILE

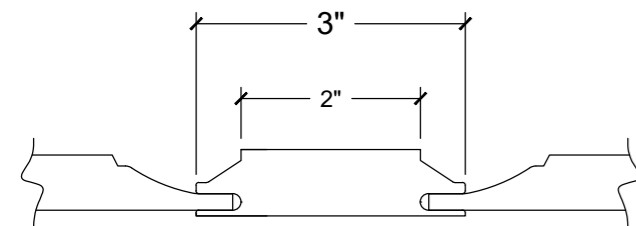

1LITE FRAME RAIL PROFILE

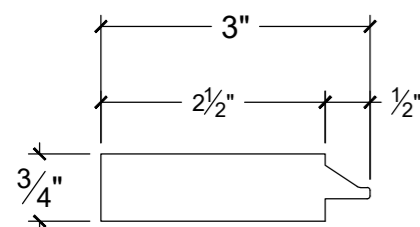

SMALL DRAWER FRONT OPTIONS (6"H):

SLAB

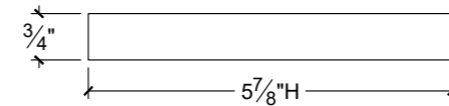
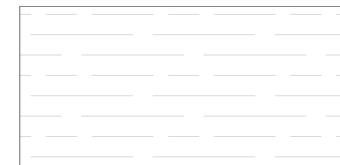

RECESSED

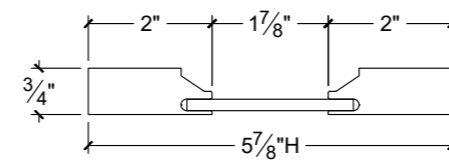
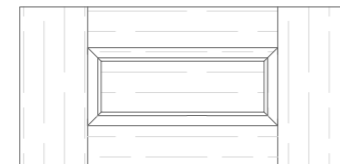

RAIL WIDTHS:

- Vertical rails will match door rails.
- Top & bottom rails are reduced.

MINIMUM SIZE:

- 9"W X 5 7/8"H

- Smaller sizes will be Slab.

LARGE DRAWER FRONT OPTIONS:

SLAB

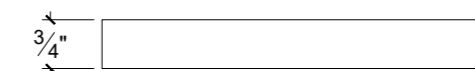
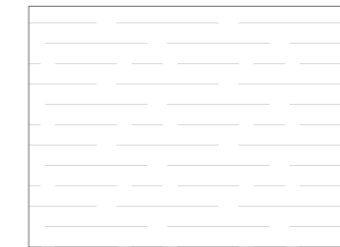

RECESSED

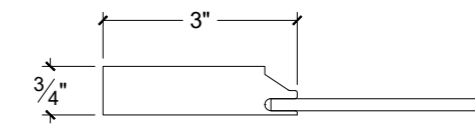
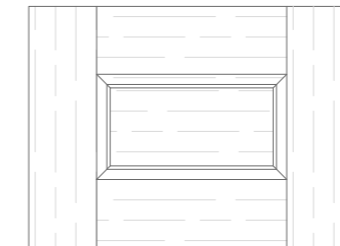

DOOR MATCH

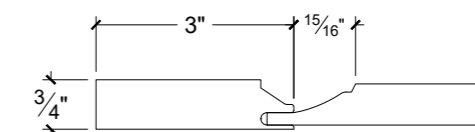
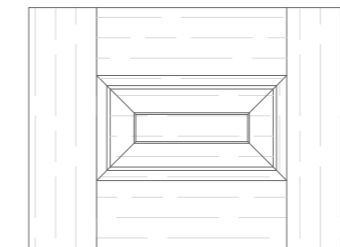

ALPHA WOOD DOOR:



MAPLE SHADOW

DOOR STYLE SPECIFICATIONS:

DOOR CONSTRUCTION:

- 5 Piece Wood Door with Recessed Veneer Centre Panel.

MINIMUM SIZE:

- 6 1/2"W x 6 1/2"H.
- Smaller sizes will be manufactured with reduced rails or be Slab.
- Subject to cabinet minimums.

MAXIMUM SIZE:

- 24"W x 48"H.
- Larger doors will have cross rails. Cross Rails can be removed at no charge but will void warranty.

GLASS DOORS:

- Frame (1-LITE) & Mullions available.

WAINSCOT PANELS:

- Available.

DOOR MATCH FILLERS/PILASTERS:

- Available.
- Minimum width: 3 1/2"W.

COMPLIMENTARY DOOR STYLES:

- NORTSHORE (1 Piece MDF Door)

SPECIES AVAILABLE:

- Alder, Clear
- Alder Knotty (Reverse Raised Panel only)
- Cherry
- Maple
- Oak, Red Flat
- Oak, White Flat
- Oak, White Rift
- Walnut

DOOR PROFILE:

DOOR PROFILE

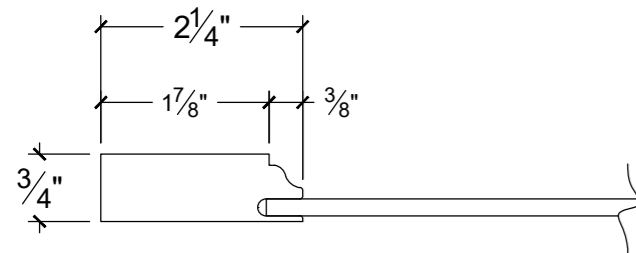

CROSS RAIL PROFILE

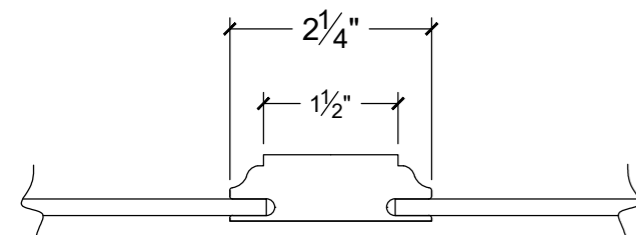

1LITE FRAME RAIL & MULLION PROFILES

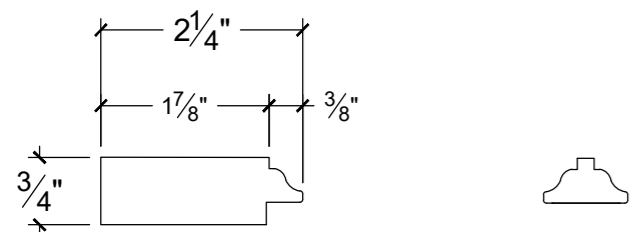

SMALL DRAWER FRONT OPTIONS (6"H):

SLAB

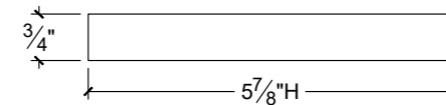
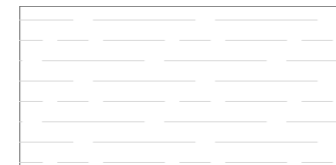

DOOR MATCH

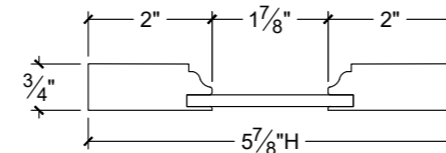

RAIL WIDTHS:

- Vertical rails will match door rails.
- Top & bottom rails are reduced.

MINIMUM SIZE:

- 6 1/2"W x 5 7/8"H
- Smaller sizes will be Slab.

LARGE DRAWER FRONT OPTIONS:

SLAB

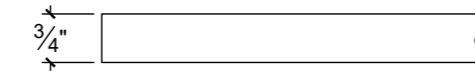
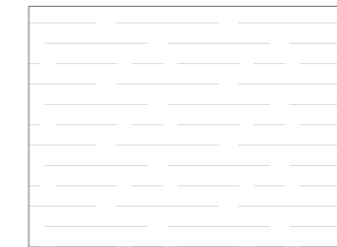

DOOR MATCH

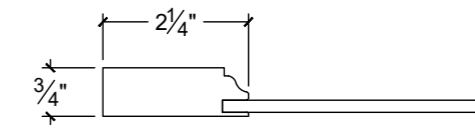
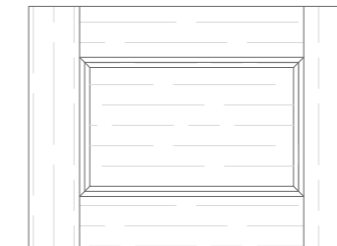

BAYVIEW WOOD DOOR:



MAPLE
HAZELNUT

DOOR STYLE SPECIFICATIONS:

DOOR CONSTRUCTION:

- 5 Piece Wood Door with Raised Centre Panel.

MINIMUM SIZE:

- 11"W x 11"H.

- Smaller sizes will be manufactured with reduced rails or be Slab.

- Subject to cabinet minimums.

MAXIMUM SIZE:

- 24"W x 48"H.

- Larger doors will have cross rails. Cross Rails can be removed at no charge but will void warranty.

GLASS DOORS:

- Frame (1-LITE) & Mullions available.

WAINSCOT PANELS:

- Available.

- Edge profile will be defaulted to square.

DOOR MATCH FILLERS/PILASTERS:

- Available.

- Minimum width: 3 1/2"W.

- Centre panel will be flat veneer.

SPECIES AVAILABLE:

- Alder, Clear
- Alder Knotty
- Maple
- Oak, Red Flat
- Oak, White Flat
- Oak, White Rift
- Walnut

DOOR PROFILE:

DOOR PROFILE

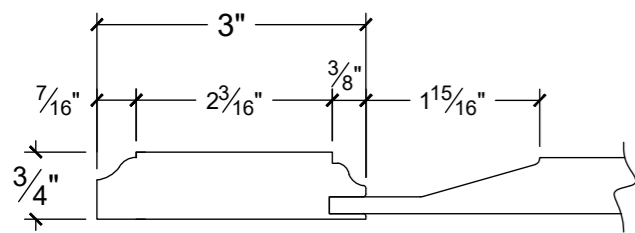

CROSS RAIL PROFILE

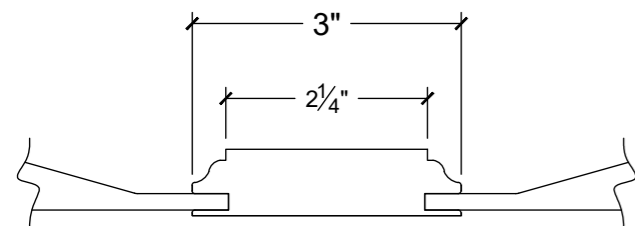

1LITE FRAME RAIL & MULLION PROFILES

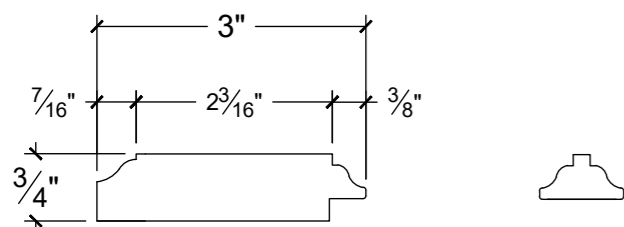

SMALL DRAWER FRONT OPTIONS (6"H):

SLAB

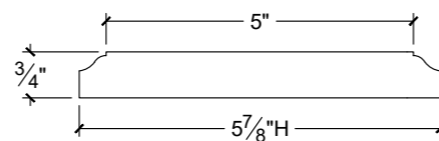
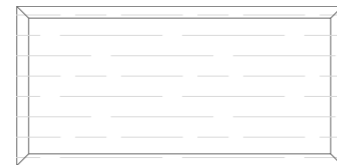

RECESSED

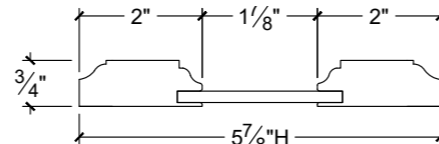
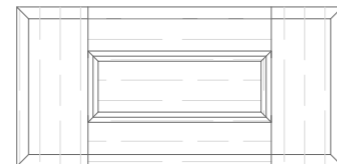

RAIL WIDTHS:

- Vertical rails will match door rails.
- Top & bottom rails are reduced.

MINIMUM SIZE:

- 11"W x 5 7/8"H

- Smaller sizes will be Slab.

LARGE DRAWER FRONT OPTIONS:

SLAB

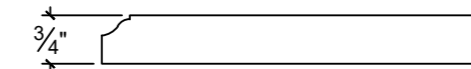
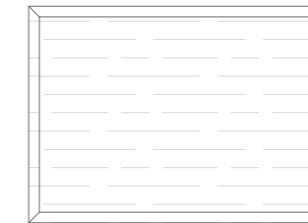

RECESSED

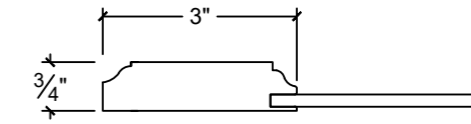
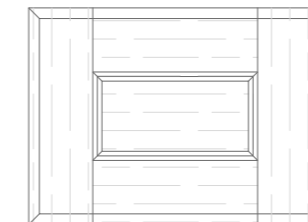

DOOR MATCH

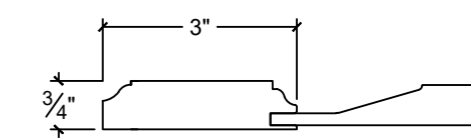
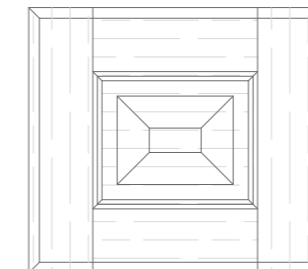

MINIMUM SIZE:

- 11"W x 11"H

- Smaller sizes will be Recessed.

BROOKFIELD WOOD DOOR:



OAK, WHITE FLAT
AZUR

DOOR STYLE SPECIFICATIONS:

DOOR CONSTRUCTION:

- 5 Piece Wood Door with Recessed Veneer Centre Panel.

MINIMUM SIZE:

- 8"W x 8"H.
- Smaller sizes will be manufactured with reduced rails or be Slab.
- Subject to cabinet minimums.

MAXIMUM SIZE:

- 24"W x 48"H.
- Larger doors will have cross rails. Cross Rails can be removed at no charge but will void warranty.

GLASS DOORS:

- Frame (1-LITE) & Mullions available.

WAINSCOT PANELS:

- Available.
- Edge profile will be defaulted to square.

DOOR MATCH FILLERS/PILASTERS:

- Available.
- Minimum width: 3 1/2"W.

SPECIES AVAILABLE:

- Alder, Clear
- Alder Knotty (Reverse Raised Panel only)
- Cherry
- Maple
- Oak, Red Flat
- Oak, White Flat
- Oak, White Rift
- Walnut

DOOR PROFILE:

DOOR PROFILE

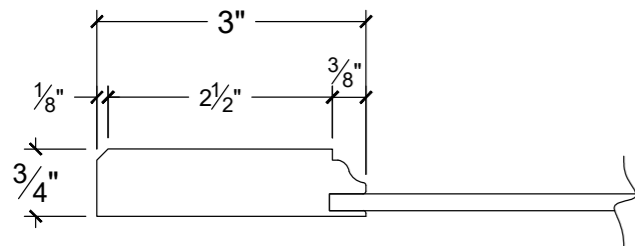

CROSS RAIL PROFILE

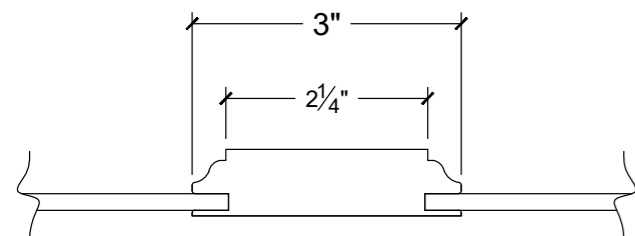

1LITE FRAME RAIL & MULLION PROFILES

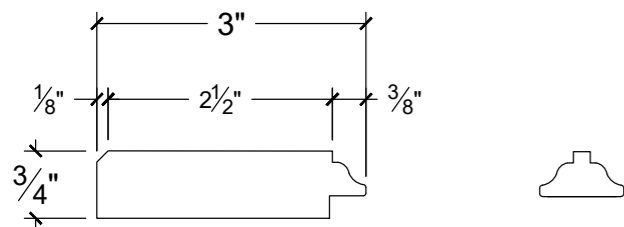

SMALL DRAWER FRONT OPTIONS (6"H):

SLAB

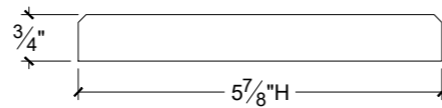

DOOR MATCH

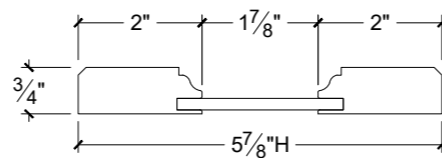
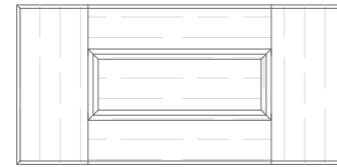

RAIL WIDTHS:

- Vertical rails will match door rails.
- Top & bottom rails are reduced.

MINIMUM SIZE:

- 8"W x 5 7/8"H
- Smaller sizes will be Slab.

LARGE DRAWER FRONT OPTIONS:

SLAB

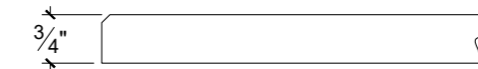

DOOR MATCH

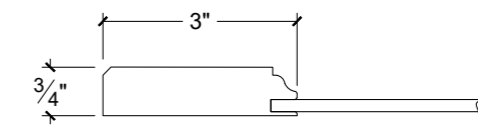
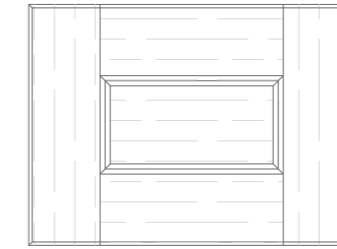

CAMDEN WOOD DOOR:



MAPLE
CHOCOLATE &
BLACK GLAZE

DOOR STYLE SPECIFICATIONS:

DOOR CONSTRUCTION:

- 5 Piece Wood Door with Raised Centre Panel.

MINIMUM SIZE:

- 9 1/2"W x 9 1/2"H.

- Smaller sizes will be manufactured with reduced rails or be Slab.

- Subject to cabinet minimums.

MAXIMUM SIZE:

- 24"W x 48"H.

- Larger doors will have cross rails. Cross Rails can be removed at no charge but will void warranty.

GLASS DOORS:

- 1LITE Frame only.

- Mullions not available.

WAINSCOT PANELS:

- Available.

- Edge profile will be defaulted to square.

DOOR MATCH FILLERS/PILASTERS:

- Available.

- Minimum width: 3 1/2"W.

- Centre panel will be flat veneer.

COMPLIMENTARY DOOR STYLES:

- CAPRI

SPECIES AVAILABLE:

- Alder, Clear
- Alder Knotty
- Cherry
- Maple
- Oak, Red Flat
- Oak, White Flat
- Oak, White Rift
- Walnut

DOOR PROFILE:

DOOR PROFILE

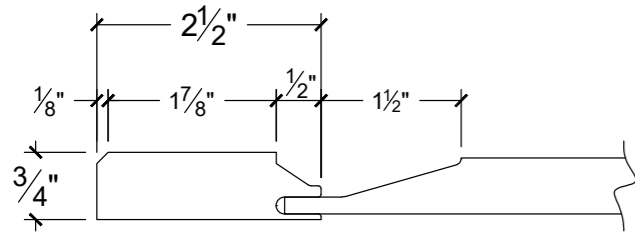

CROSS RAIL PROFILE

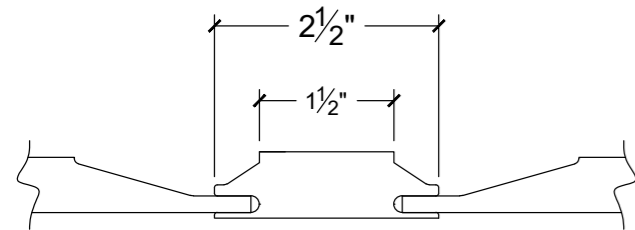

1LITE FRAME RAIL PROFILE

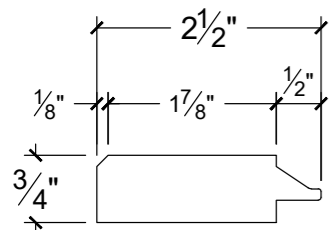

SMALL DRAWER FRONT OPTIONS (6"H):

SLAB

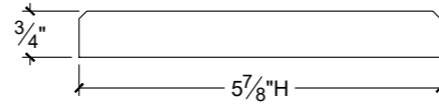
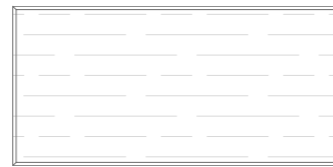

RECESSED

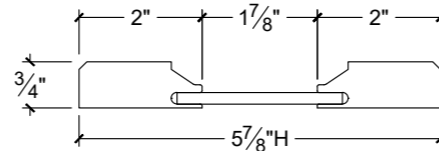
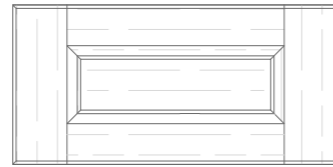

RAIL WIDTHS:

- Vertical rails will match door rails.
- Top & bottom rails are reduced.

MINIMUM SIZE:

- 9 1/2"W x 5 7/8"H

- Smaller sizes will be Slab.

LARGE DRAWER FRONT OPTIONS:

SLAB

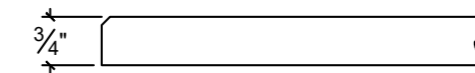
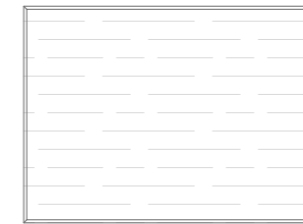

RECESSED

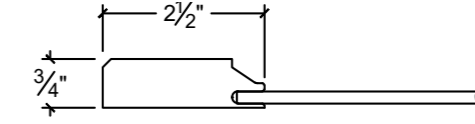
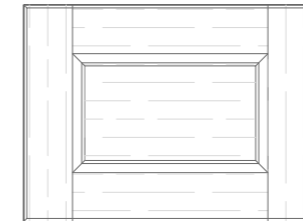

DOOR MATCH

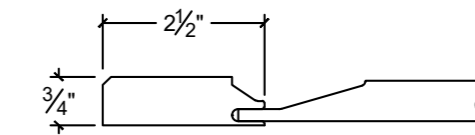
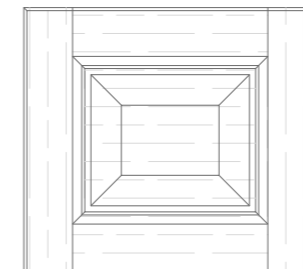

MINIMUM SIZE:

- 9 1/2"W x 9 1/2"H

- Smaller sizes will be Recessed.

CAPRI WOOD DOOR:



MAPLE
CONCRETE

DOOR STYLE SPECIFICATIONS:

DOOR CONSTRUCTION:

- 5 Piece Wood Door with Recessed Veneer Centre Panel.

MINIMUM SIZE:

- 7"W x 7"H.
- Smaller sizess will be manufactured with reduced rails or be Slab.
- Subject to cabinet minimums.

MAXIMUM SIZE:

- 24"W x 48"H.
- Larger doors will have cross rails. Cross Rails can be removed at no charge but will void warranty.

GLASS DOORS:

- 1LITE Frame only.
- Mullions not available.

WAINSCOT PANELS:

- Available.
- Edge profile will be defaulted to square.

DOOR MATCH FILLERS/PILASTERS:

- Available.
- Minimum width: 3 1/2"W.

COMPLIMENTARY DOOR STYLES:

- CAMDEN
- OSTIA

SPECIES AVAILABLE:

- Alder, Clear
- Alder Knotty (Reverse Raised Panel only)
- Cherry
- Maple
- Oak, Red Flat
- Oak, White Flat
- Oak, White Rift
- Walnut

DOOR PROFILE:

DOOR PROFILE

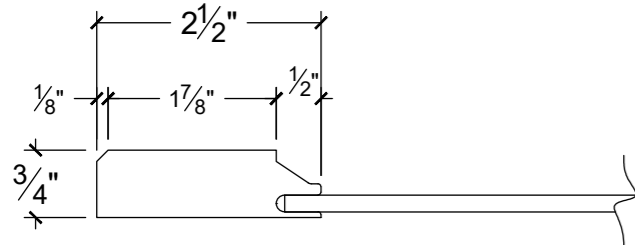

CROSS RAIL PROFILE

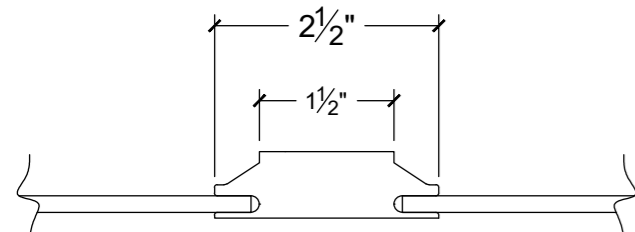

1LITE FRAME RAIL PROFILE

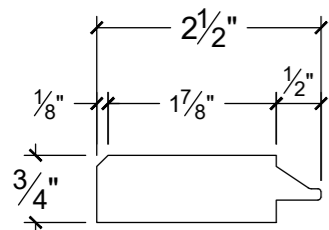

SMALL DRAWER FRONT OPTIONS (6"H):

SLAB

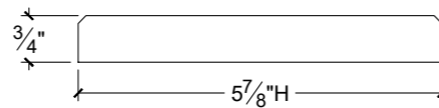
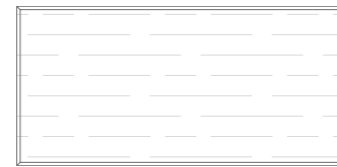

DOOR MATCH

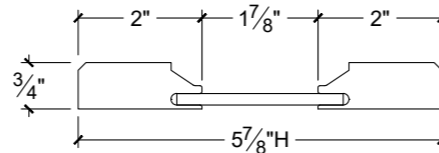

RAIL WIDTHS:

- Vertical rails will match door rails.
- Top & bottom rails are reduced.

MINIMUM SIZE:

- 7"W x 5 7/8"H
- Smaller sizes will be Slab.

LARGE DRAWER FRONT OPTIONS:

SLAB

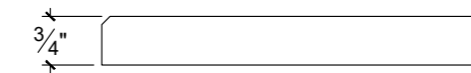

DOOR MATCH

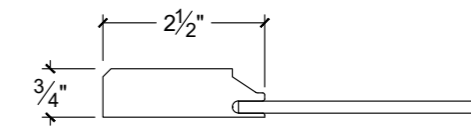
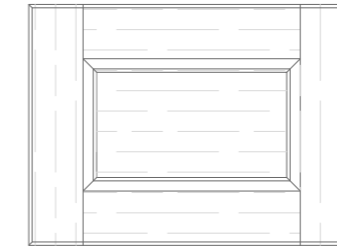

CLASSIC WOOD DOOR:



MAPLE
MUSKOKA &
BLACK GLAZE

DOOR STYLE SPECIFICATIONS:

DOOR CONSTRUCTION:

- 5 Piece Wood Door with Raised Centre Panel.

MINIMUM SIZE:

- 8 1/4"W x 8 1/4"H.

- Smaller sizes will be manufactured with reduced rails or be Slab.

- Subject to cabinet minimums.

MAXIMUM SIZE:

- 24"W x 48"H.

- Larger doors will have cross rails. Cross Rails can be removed at no charge but will void warranty.

GLASS DOORS:

- Frame (1-LITE) & Mullions available.

WAINSCOT PANELS:

- Available.

- Edge profile will be defaulted to square.

DOOR MATCH FILLERS/PILASTERS:

- Available.

- Minimum width: 3 1/2"W.

- Centre panel will be flat veneer.

COMPLIMENTARY DOOR STYLES:

- PICASSO

SPECIES AVAILABLE:

- Alder, Clear
- Alder Knotty
- Maple
- Oak, Red Flat
- Oak, White Flat
- Oak, White Rift
- Walnut

DOOR PROFILE:

DOOR PROFILE

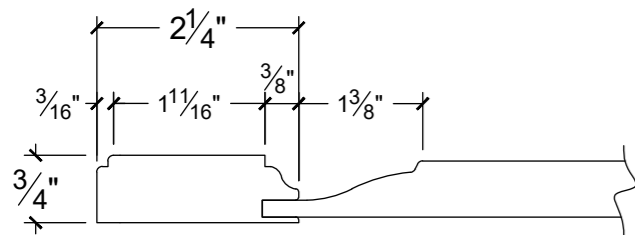

CROSS RAIL PROFILE

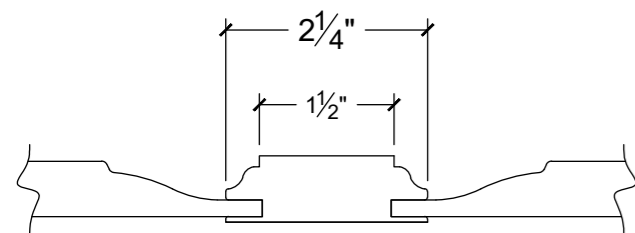

1LITE FRAME RAIL & MULLION PROFILES

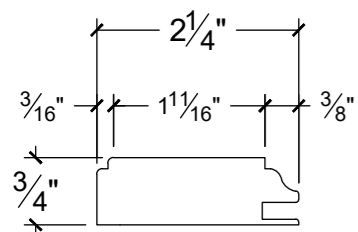

SMALL DRAWER FRONT OPTIONS (6"H):

SLAB

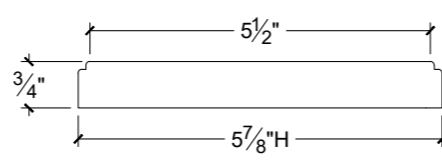
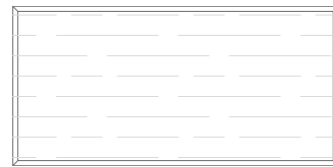

RECESSED

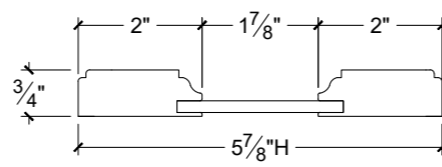
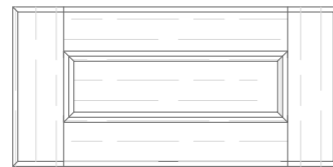

RAIL WIDTHS:

- Vertical rails will match door rails.
- Top & bottom rails are reduced.

MINIMUM SIZE:

- 8 1/4"W x 5 7/8"H

- Smaller sizes will be Slab.

LARGE DRAWER FRONT OPTIONS:

SLAB

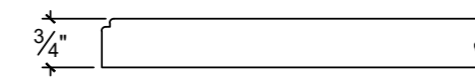
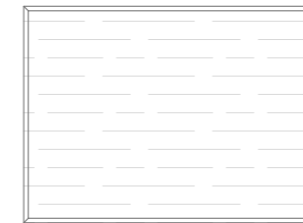

RECESSED

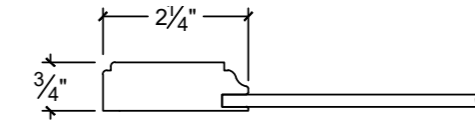
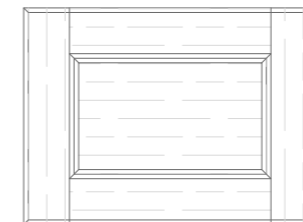

DOOR MATCH

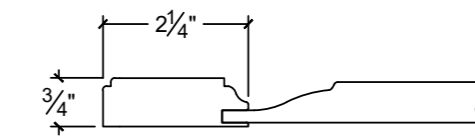
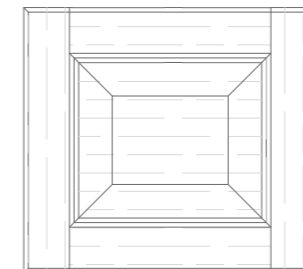

MINIMUM SIZE:

- 8 1/4"W x 8 1/4"H

- Smaller sizes will be Recessed.

COLONIAL WOOD DOOR:



MAPLE
APPLESEED

DOOR STYLE SPECIFICATIONS:

DOOR CONSTRUCTION:

- 5 Piece Wood Door with Recessed Veneer Centre Panel.

MINIMUM SIZE:

- 8"W x 8"H.
- Smaller sizess will be manufactured with reduced rails or be Slab.
- Subject to cabinet minimums.

MAXIMUM SIZE:

- 24"W x 48"H.
- Larger doors will have cross rails. Cross Rails can be removed at no charge but will void warranty.

GLASS DOORS:

- Frame (1-LITE) & Mullions available.

WAINSCOT PANELS:

- Available.
- Edge profile will be defaulted to square.

DOOR MATCH FILLERS/PILASTERS:

- Available.
- Minimum width: 3 1/2"W.

COMPLIMENTARY DOOR STYLES:

- ENGLISH MANOR

SPECIES AVAILABLE:

- Alder, Clear
- Alder Knotty (Reverse Raised Panel only)
- Cherry
- Maple
- Oak, Red Flat
- Oak, White Flat
- Oak, White Rift
- Walnut

DOOR PROFILE:

DOOR PROFILE

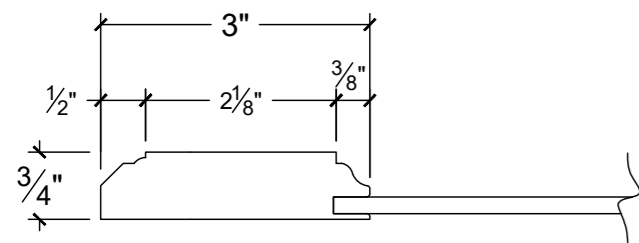

CROSS RAIL PROFILE

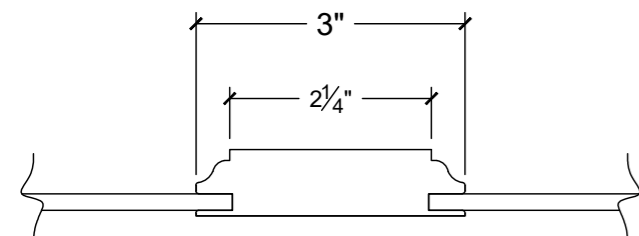

1LITE FRAME RAIL & MULLION PROFILES

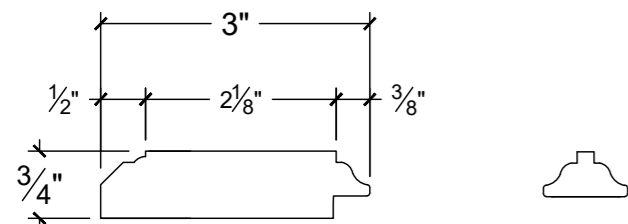

SMALL DRAWER FRONT OPTIONS (6"H):

SLAB

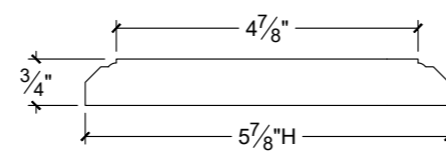

DOOR MATCH

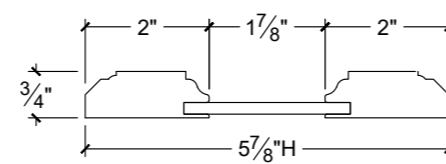
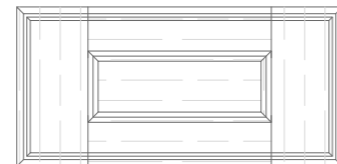

RAIL WIDTHS:

- Vertical rails will match door rails.
- Top & bottom rails are reduced.

MINIMUM SIZE:

- 8"W x 5 7/8"H
- Smaller sizes will be Slab.

LARGE DRAWER FRONT OPTIONS:

SLAB

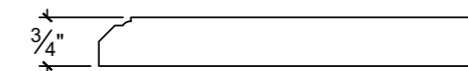

DOOR MATCH

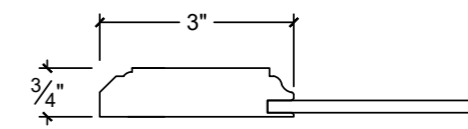
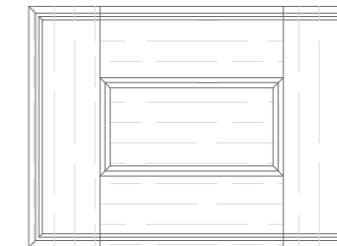

ENGLISH MANOR WOOD DOOR:



MAPLE
BORDEAUX

DOOR STYLE SPECIFICATIONS:

DOOR CONSTRUCTION:

- 5 Piece Wood Door with Raised Centre Panel.

MINIMUM SIZE:

- 9"W x 9"H.

- Smaller sizes will be manufactured with reduced rails or be Slab.

- Subject to cabinet minimums.

MAXIMUM SIZE:

- 24"W x 48"H.

- Larger doors will have cross rails. Cross Rails can be removed at no charge but will void warranty.

GLASS DOORS:

- Frame (1-LITE) & Mullions available.

WAINSCOT PANELS:

- Available.

- Edge profile will be defaulted to square.

DOOR MATCH FILLERS/PILASTERS:

- Available.

- Minimum width: 3 1/2"W.

- Centre panel will be flat veneer.

COMPLIMENTARY DOOR STYLES:

- COLONIAL

SPECIES AVAILABLE:

- Alder, Clear
- Alder Knotty
- Maple
- Oak, Red Flat
- Oak, White Flat
- Oak, White Rift
- Walnut

DOOR PROFILE:

DOOR PROFILE

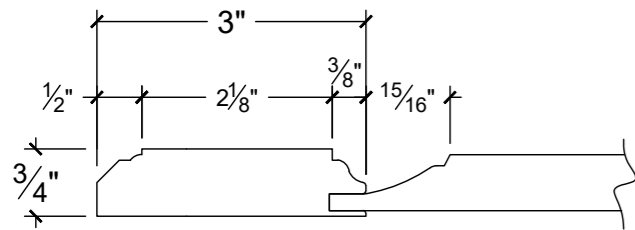

CROSS RAIL PROFILE

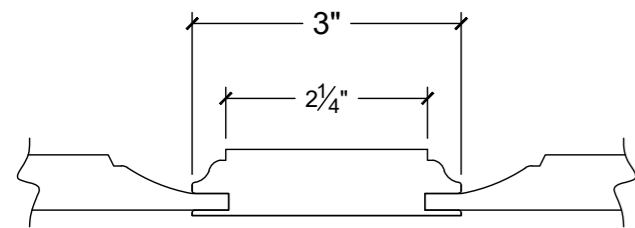

1LITE FRAME RAIL & MULLION PROFILES

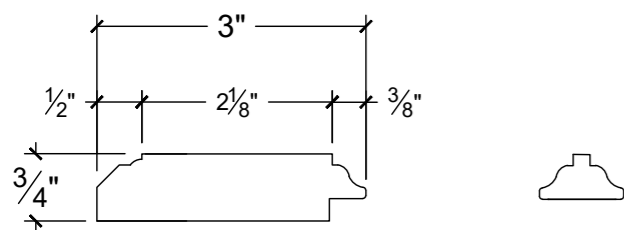

SMALL DRAWER FRONT OPTIONS (6"H):

SLAB

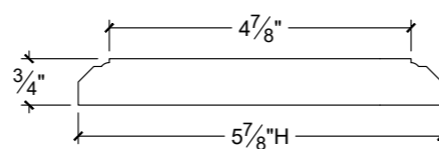

RECESSED

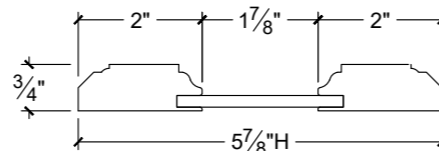
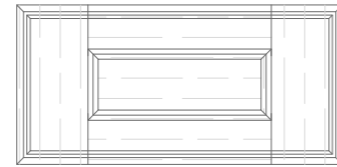

RAIL WIDTHS:

- Vertical rails will match door rails.
- Top & bottom rails are reduced.

MINIMUM SIZE:

- 9"W x 5 7/8"H

- Smaller sizes will be Slab.

LARGE DRAWER FRONT OPTIONS:

SLAB

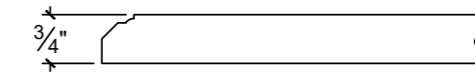

RECESSED

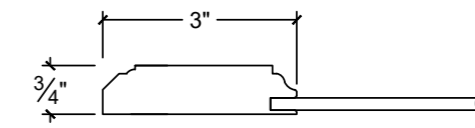
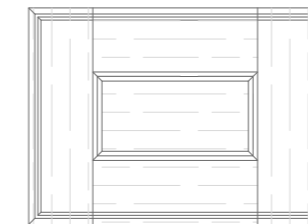

DOOR MATCH

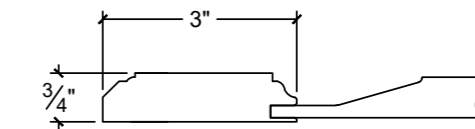
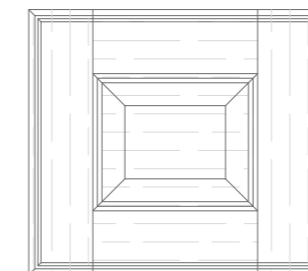

MINIMUM SIZE:

- 9"W x 9"H

- Smaller sizes will be Recessed.

ESQUIRE WOOD DOOR:



MAPLE
MASALA

DOOR STYLE SPECIFICATIONS:

DOOR CONSTRUCTION:

- 5 Piece Wood Door with Recessed Veneer Centre Panel.

MINIMUM SIZE:

- 7"W x 7"H.
- Smaller sizes will be manufactured with reduced rails or be Slab.
- Subject to cabinet minimums.

MAXIMUM SIZE:

- 24"W x 48"H.
- Larger doors will have cross rails. Cross Rails can be removed at no charge but will void warranty.

GLASS DOORS:

- 1LITE Frame only.
- Mullions not available.

WAINSCOT PANELS:

- Available.

DOOR MATCH FILLERS/PILASTERS:

- Available.
- Minimum width: 3 1/2"W.

COMPLIMENTARY DOOR STYLES:

- GEORGIA

SPECIES AVAILABLE:

- Alder, Clear
- Alder Knotty (Reverse Raised Panel only)
- Cherry
- Maple
- Oak, Red Flat
- Oak, White Flat
- Oak, White Rift
- Walnut

DOOR PROFILE:

DOOR PROFILE

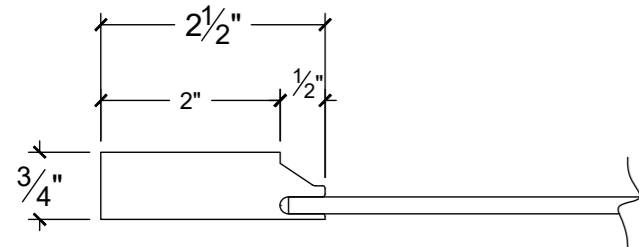

CROSS RAIL PROFILE

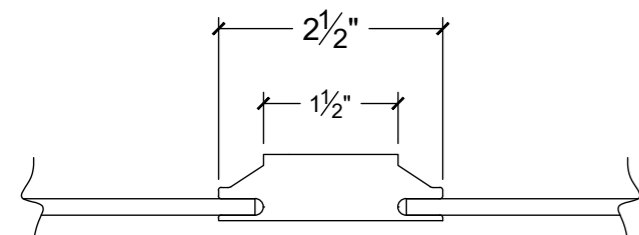

1LITE FRAME RAIL PROFILE

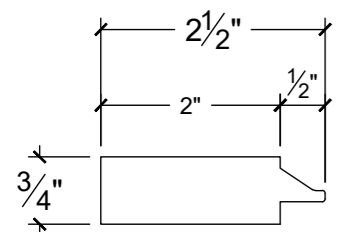

SMALL DRAWER FRONT OPTIONS (6"H):

SLAB

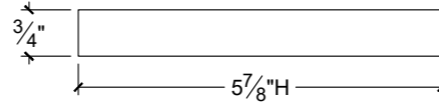
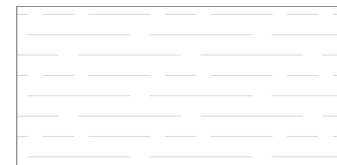

DOOR MATCH

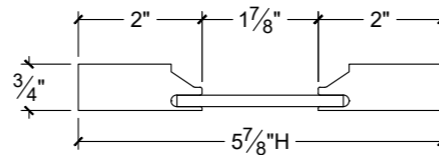
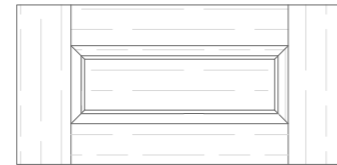

RAIL WIDTHS:

- Vertical rails will match door rails.
- Top & bottom rails are reduced.

MINIMUM SIZE:

- 7"W x 5 7/8"H
- Smaller sizes will be Slab.

LARGE DRAWER FRONT OPTIONS:

SLAB

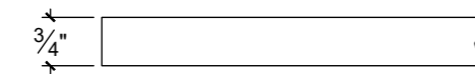
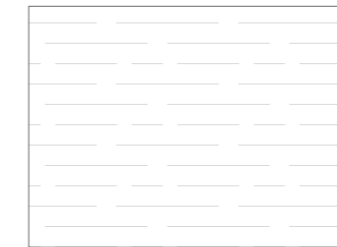

DOOR MATCH

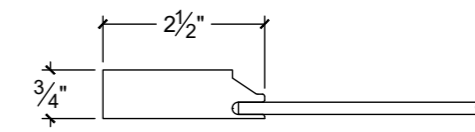
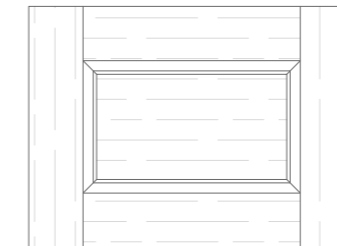

GENEVA WOOD DOOR:



CHERRY
GUNSTOCK

DOOR STYLE SPECIFICATIONS:

DOOR CONSTRUCTION:

- 5 Piece Wood Door with Recessed Veneer Centre Panel.

MINIMUM SIZE:

- 7 1/2"W x 7 1/2"H.
- Smaller sizes will be manufactured with reduced rails or be Slab.
- Subject to cabinet minimums.

MAXIMUM SIZE:

- 24"W x 48"H.
- Larger doors will have cross rails. Cross Rails can be removed at no charge but will void warranty.

GLASS DOORS:

- 1LITE Frame only.
- Mullions not available.

WAINSCOT PANELS:

- Available.

DOOR MATCH FILLERS/PILASTERS:

- Available.
- Minimum width: 3 1/2"W.

COMPLIMENTARY DOOR STYLES:

- LINWELL

SPECIES AVAILABLE:

- Alder, Clear
- Alder Knotty (Reverse Raised Panel only)
- Cherry
- Maple
- Oak, Red Flat
- Oak, White Flat
- Oak, White Rift
- Walnut

DOOR PROFILE:

DOOR PROFILE

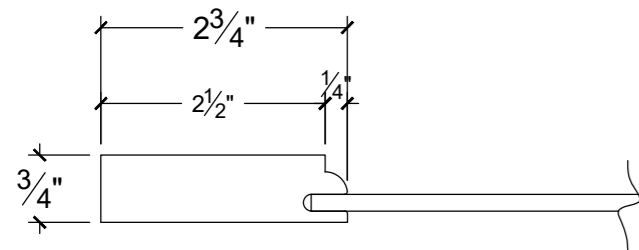

CROSS RAIL PROFILE

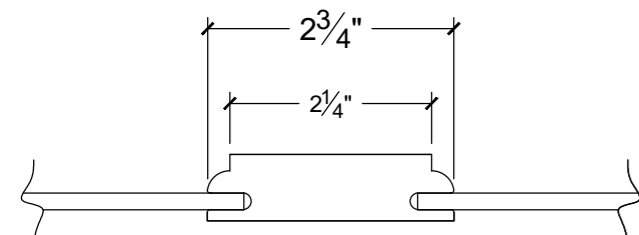

1LITE FRAME RAIL PROFILE

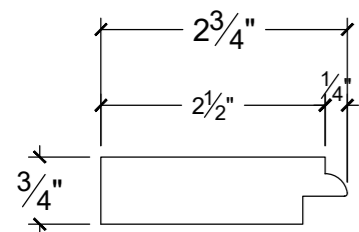

SMALL DRAWER FRONT OPTIONS (6"H):

SLAB

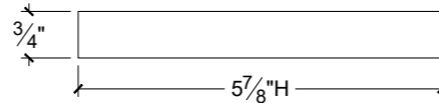
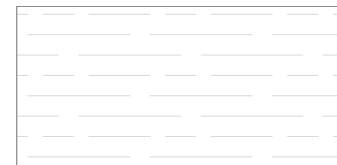

DOOR MATCH

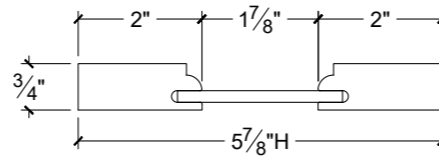
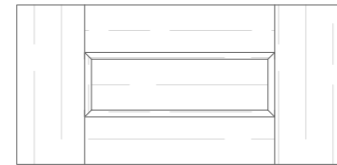

RAIL WIDTHS:

- Vertical rails will match door rails.
- Top & bottom rails are reduced.

MINIMUM SIZE:

- 7 1/2"W X 5 7/8"H
- Smaller sizes will be Slab.

LARGE DRAWER FRONT OPTIONS:

SLAB

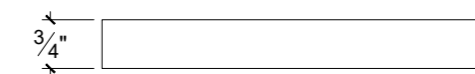
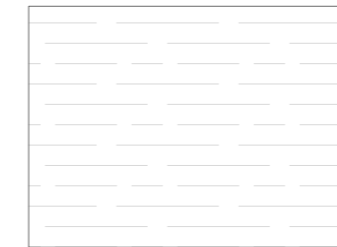

DOOR MATCH

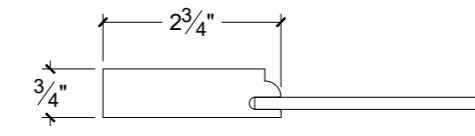
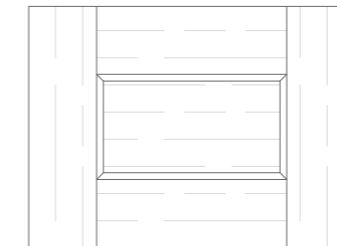

GEORGIA WOOD DOOR:



MAPLE SHADOW

DOOR STYLE SPECIFICATIONS:

DOOR CONSTRUCTION:

- 5 Piece Wood Door with Raised Centre Panel.

MINIMUM SIZE:

- 9"W x 9"H.

- Smaller sizes will be manufactured with reduced rails or be Slab.

- Subject to cabinet minimums.

MAXIMUM SIZE:

- 24"W x 48"H.

- Larger doors will have cross rails. Cross Rails can be removed at no charge but will void warranty.

GLASS DOORS:

- 1LITE Frame only.

- Mullions not available.

WAINSCOT PANELS:

- Available.

DOOR MATCH FILLERS/PILASTERS:

- Available.

- Minimum width: 3 1/2"W.

- Centre panel will be flat veneer.

COMPLIMENTARY DOOR STYLES:

- ESQUIRE

SPECIES AVAILABLE:

- Alder, Clear
- Alder Knotty
- Cherry
- Maple
- Oak, Red Flat
- Oak, White Flat
- Oak, White Rift
- Walnut

DOOR PROFILE:

DOOR PROFILE

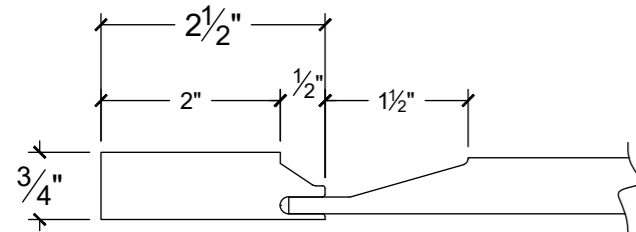

CROSS RAIL PROFILE

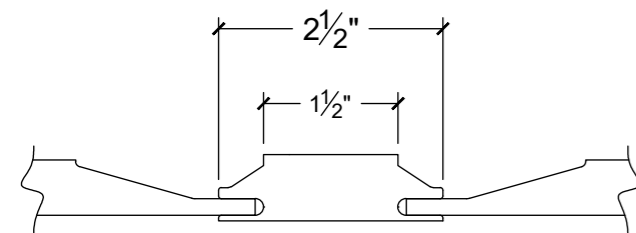

1LITE FRAME RAIL PROFILE

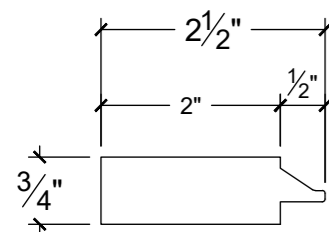

SMALL DRAWER FRONT OPTIONS (6"H):

SLAB

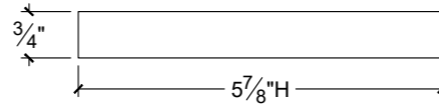
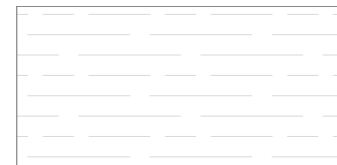

RECESSED

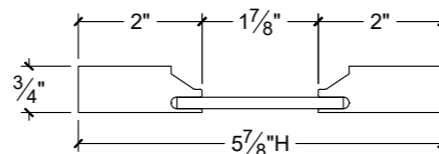
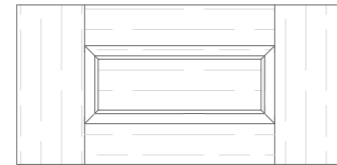

RAIL WIDTHS:

- Vertical rails will match door rails.
- Top & bottom rails are reduced.

MINIMUM SIZE:

- 9"W X 5 7/8"H

- Smaller sizes will be Slab.

LARGE DRAWER FRONT OPTIONS:

SLAB

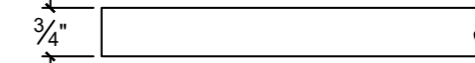

RECESSED

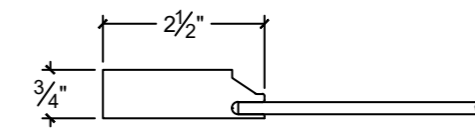
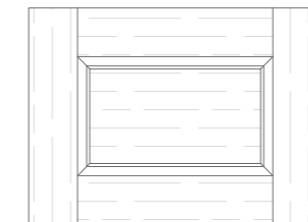

DOOR MATCH

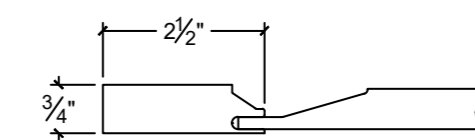
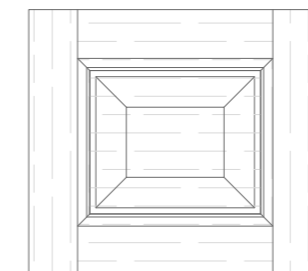

MINIMUM SIZE:

- 9"W x 9"H

- Smaller sizes will be Recessed.

GRANTHAM WOOD DOOR:



WALNUT THUNDER

DOOR STYLE SPECIFICATIONS:

DOOR CONSTRUCTION:

- 5 Piece Wood Door with Recessed Veneer Centre Panel.

MINIMUM SIZE:

- 6 1/2"W x 6 1/2"H.
- Smaller sizes will be manufactured with reduced rails or be Slab.
- Subject to cabinet minimums.

MAXIMUM SIZE:

- 24"W x 48"H.
- Larger doors will have cross rails. Cross Rails can be removed at no charge but will void warranty.

GLASS DOORS:

- 1LITE Frame only.
- Mullions not available.

WAINSCOT PANELS:

- Available.

DOOR MATCH FILLERS/PILASTERS:

- Available.
- Minimum width: 3 1/2"W.

COMPLIMENTARY DOOR STYLES:

- QUEENSTON

SPECIES AVAILABLE:

- Alder, Clear
- Alder Knotty (Reverse Raised Panel only)
- Cherry
- Maple
- Oak, Red Flat
- Oak, White Flat
- Oak, White Rift
- Walnut

DOOR PROFILE:

DOOR PROFILE

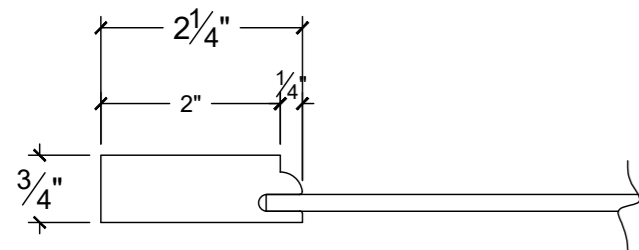

CROSS RAIL PROFILE

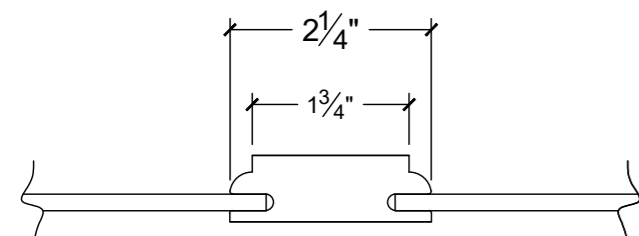

1LITE FRAME RAIL PROFILE

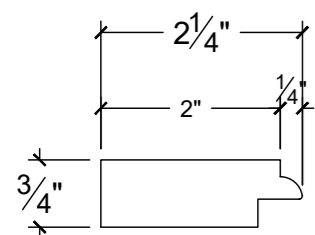

SMALL DRAWER FRONT OPTIONS (6"H):

SLAB

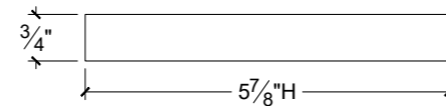
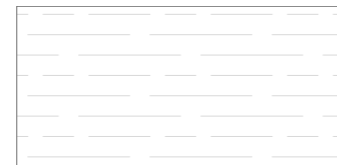

DOOR MATCH

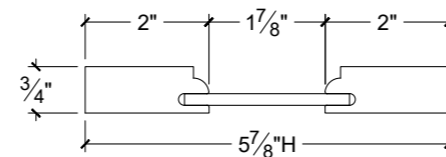

RAIL WIDTHS:

- Vertical rails will match door rails.
- Top & bottom rails are reduced.

MINIMUM SIZE:

- 6 1/2"W X 5 7/8"H
- Smaller sizes will be Slab.

LARGE DRAWER FRONT OPTIONS:

SLAB

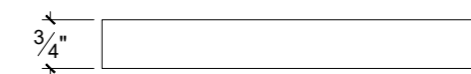
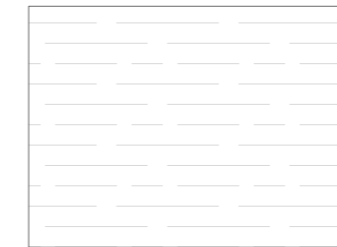

DOOR MATCH

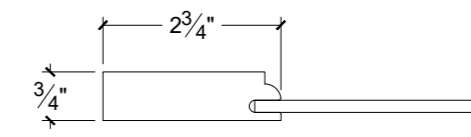
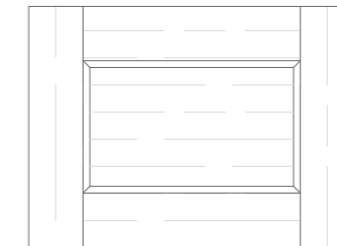

IMPERIAL WOOD DOOR:



MAPLE
EBONY

DOOR STYLE SPECIFICATIONS:

DOOR CONSTRUCTION:

- 5 Piece Wood Door with Raised Centre Panel & Applied Moulding.

MINIMUM SIZE:

- 11"W x 11"H.
- Smaller sizes will be manufactured with reduced rails or be Slab.
- Subject to cabinet minimums.

MAXIMUM SIZE:

- 24"W x 48"H.
- Larger doors will have cross rails. Cross Rails can be removed at no charge but will void warranty.

GLASS DOORS:

- Frame (1-LITE) & Mullions available.

WAINSCOT PANELS:

- Available.
- Edge profile will be defaulted to square.

DOOR MATCH FILLERS/PILASTERS:

- Available.
- Minimum width: 4 1/2"W.
- Centre panel will be flat veneer.

COMPLIMENTARY DOOR STYLES:

- ROSEDALE

SPECIES AVAILABLE:

- Alder, Clear
- Alder Knotty
- Maple
- Oak, Red Flat
- Oak, White Flat
- Oak, White Rift
- Walnut

DOOR PROFILE:

DOOR PROFILE

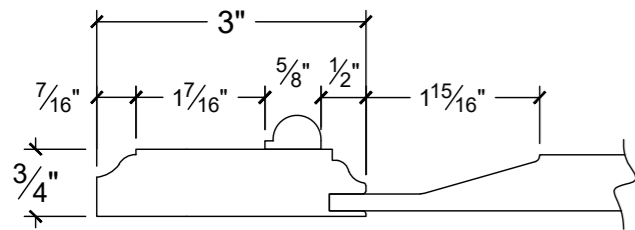

CROSS RAIL PROFILE

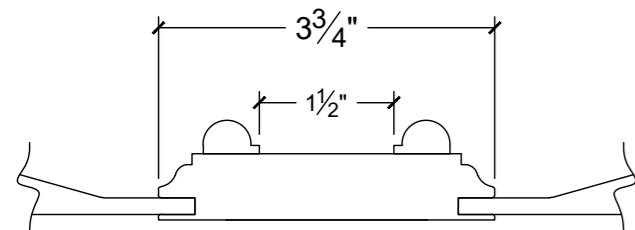

1LITE FRAME RAIL & MULLION PROFILES

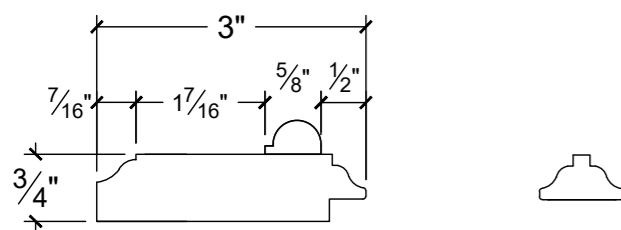

SMALL DRAWER FRONT OPTIONS (6"H):

SLAB

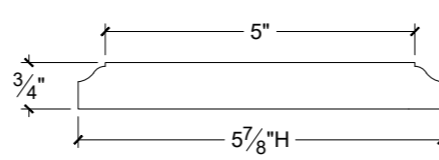
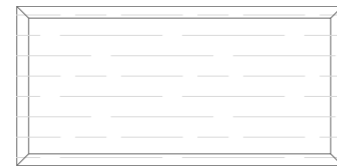

RECESSED

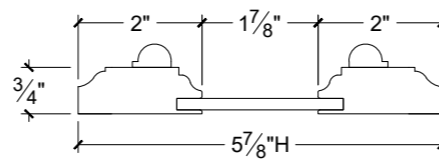
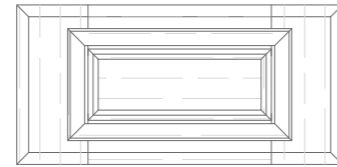

RAIL WIDTHS:

- Vertical rails will match door rails.
- Top & bottom rails are reduced.

MINIMUM SIZE:

- 11"W x 5 7/8"H
- Smaller sizes will be Slab.

LARGE DRAWER FRONT OPTIONS:

SLAB

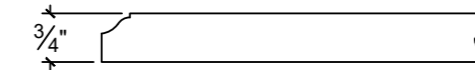
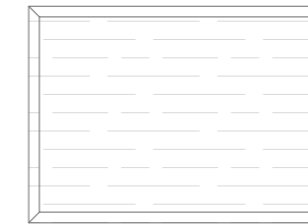

RECESSED

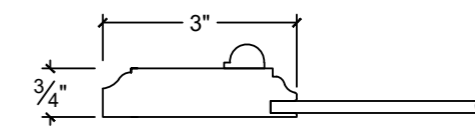
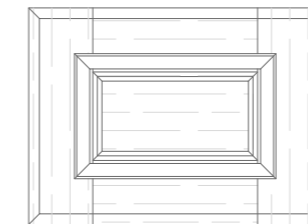

DOOR MATCH

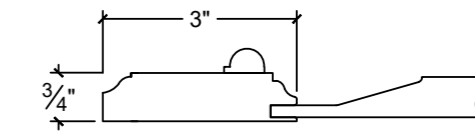
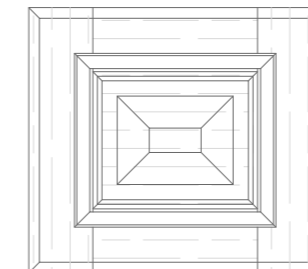

MINIMUM SIZE:

- 11"W x 11"H
- Smaller sizes will be Recessed.

LOFT WOOD WOOD DOOR:



WALNUT
LOFT WOOD

DOOR STYLE SPECIFICATIONS:

DOOR CONSTRUCTION:

- 5 Piece Wood Door with Recessed Veneer Centre Panel.

MINIMUM SIZE:

- 6"W x 6"H.
- Smaller sizes will be manufactured as Slab.
- Subject to cabinet minimums.

MAXIMUM SIZE:

- 24"W x 60"H.
- Larger doors are available but will void warranty.

GLASS DOORS:

- 1LITE Frame only.
- Mullions not available.

WAINSCOT PANELS:

- Not available.

DOOR MATCH FILLERS/PILASTERS:

- Not available.

GRAIN-MATCHING:

- Not available.

COMPLIMENTARY DOOR STYLES:

- LOFTWOOD MDF
- WYNWOOD

SPECIES AVAILABLE:

- Alder, Clear
- Cherry
- Maple
- Oak, Red Flat
- Oak, White Flat
- Oak, White Rift
- Walnut

DOOR PROFILE:

DOOR PROFILE

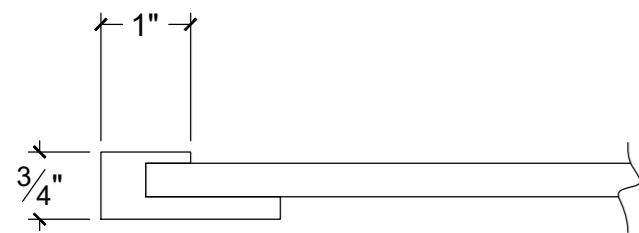

1LITE FRAME RAIL PROFILE

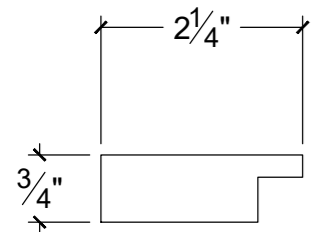

SMALL DRAWER FRONT OPTIONS (6"H):

SLAB

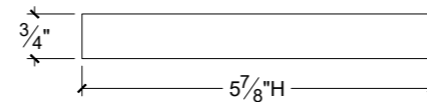
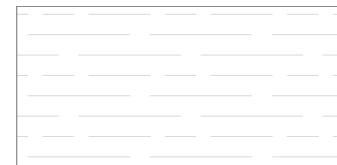

DOOR MATCH

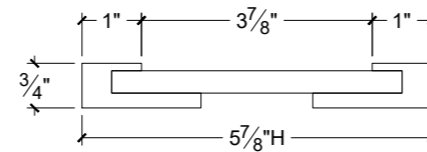
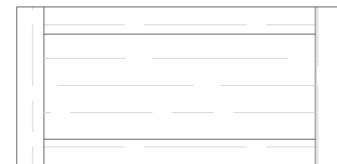

RAIL WIDTHS:

- Vertical rails will match door rails.

MINIMUM SIZE:

- 6 1/2"W X 5 7/8"H
- Smaller sizes will be Slab.

LARGE DRAWER FRONT OPTIONS:

SLAB

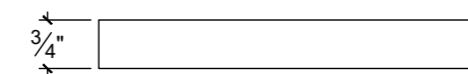
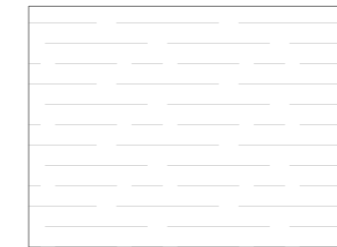

DOOR MATCH

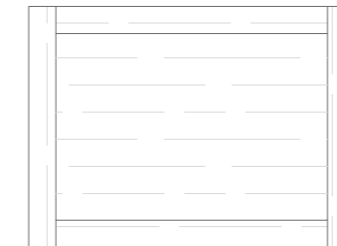

MANCHESTER WOOD DOOR:



MAPLE
MANCHESTER

DOOR STYLE SPECIFICATIONS:

DOOR CONSTRUCTION:

- 5 Piece Wood Door with Raised Centre Panel & Applied Moulding.

MINIMUM SIZE:

- 11"W x 11"H.
- Smaller sizess will be manufactured with reduced rails or be Slab.
- Subject to cabinet minimums.

MAXIMUM SIZE:

- 24"W x 48"H.
- Larger doors will have cross rails. Cross Rails can be removed at no charge but will void warranty.

GLASS DOORS:

- 1LITE Frame only.
- Mullions not available.

WAINSCOT PANELS:

- Available.
- Edge profile will be defaulted to square.

DOOR MATCH FILLERS/PILASTERS:

- Available.
- Centre panel will be flat veneer.
- Minimum width: 5"W

SPECIES AVAILABLE:

- Alder, Clear
- Alder Knotty
- Maple
- Oak, Red Flat
- Oak, White Flat
- Oak, White Rift
- Walnut

DOOR PROFILE:

DOOR PROFILE

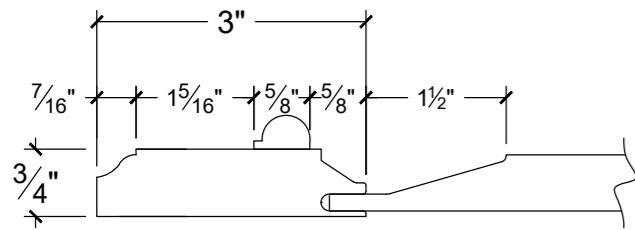

CROSS RAIL PROFILE

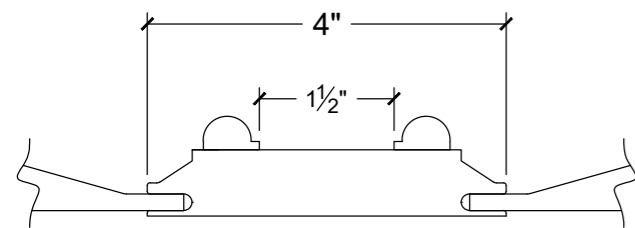

1LITE FRAME RAIL PROFILE

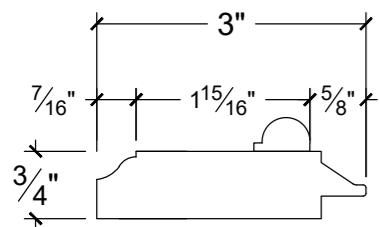

SMALL DRAWER FRONT OPTIONS (6"H):

SLAB

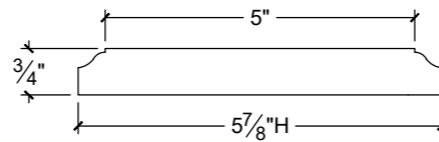
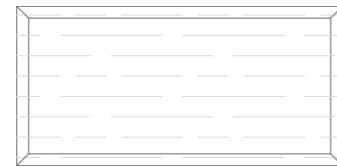

RECESSED

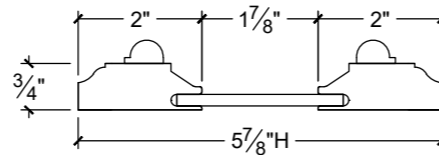
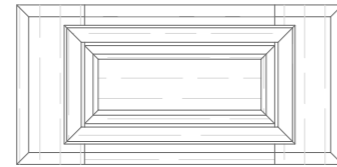

RAIL WIDTHS:

- Vertical rails will match door rails.
- Top & bottom rails are reduced.

MINIMUM SIZE:

- 11"W x 5 7/8"H
- Smaller sizes will be Slab.

LARGE DRAWER FRONT OPTIONS:

SLAB

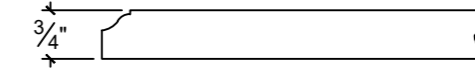
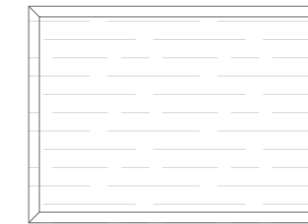

RECESSED

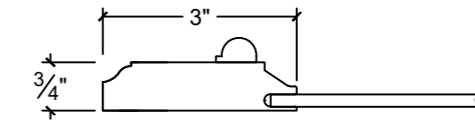
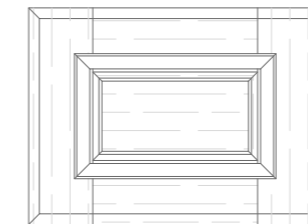

DOOR MATCH

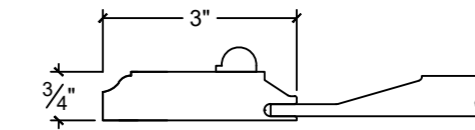
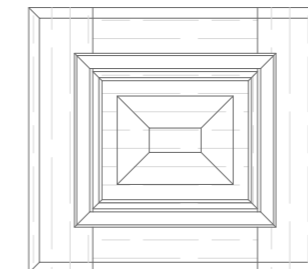

MINIMUM SIZE:

- 11"W x 11"H
- Smaller sizes will be Recessed.

MILAN WOOD DOOR:



OAK, WHITE RIFT
CONCRETE

DOOR STYLE SPECIFICATIONS:

DOOR CONSTRUCTION:

- 5 Piece Wood Door with Recessed Veneer Centre Panel.

MINIMUM SIZE:

- 8"W x 8"H.
- Smaller sizes will be manufactured with reduced rails or be Slab.
- Subject to cabinet minimums.

MAXIMUM SIZE:

- 24"W x 48"H.
- Larger doors will have cross rails. Cross Rails can be removed at no charge but will void warranty.

GLASS DOORS:

- 1LITE Frame only.
- Mullions not available.

WAINSCOT PANELS:

- Available.

DOOR MATCH FILLERS/PILASTERS:

- Available.
- Minimum width: 3 1/2"W.

SPECIES AVAILABLE:

- Alder, Clear
- Alder Knotty (Reverse Raised Panel only)
- Cherry
- Maple
- Oak, Red Flat
- Oak, White Flat
- Oak, White Rift
- Walnut

DOOR PROFILE:

DOOR PROFILE

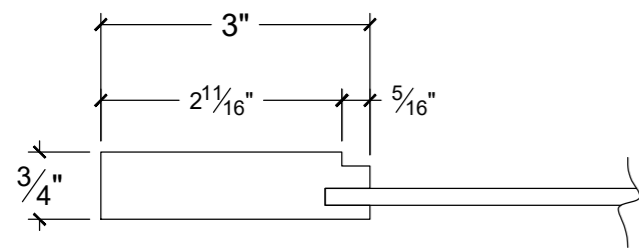

CROSS RAIL PROFILE

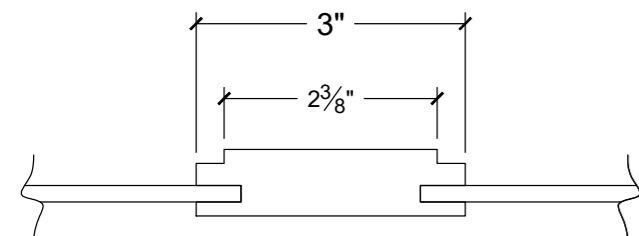

1LITE FRAME RAIL PROFILE

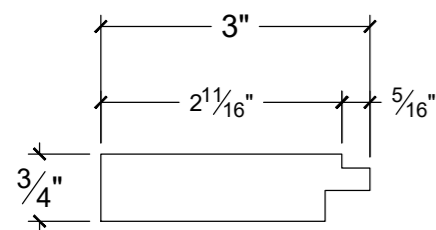

SMALL DRAWER FRONT OPTIONS (6"H):

SLAB

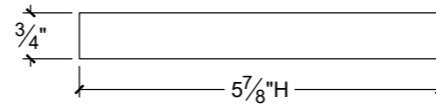
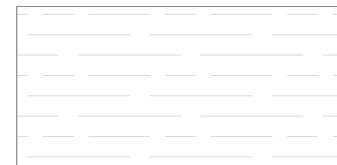

DOOR MATCH

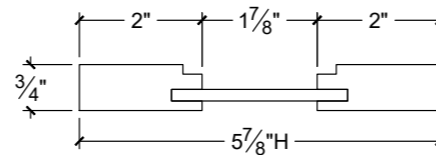
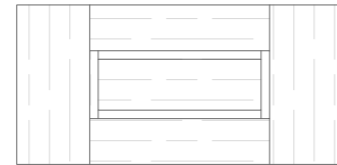

RAIL WIDTHS:

- Vertical rails will match door rails.
- Top & bottom rails are reduced.

MINIMUM SIZE:

- 8"W X 5 7/8"H
- Smaller sizes will be Slab.

LARGE DRAWER FRONT OPTIONS:

SLAB

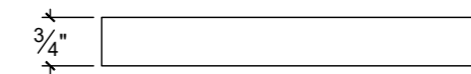
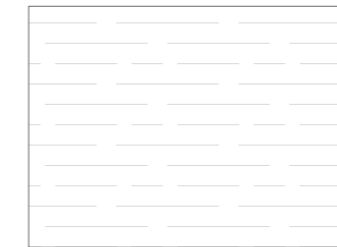

DOOR MATCH

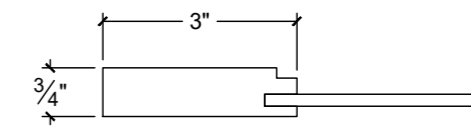
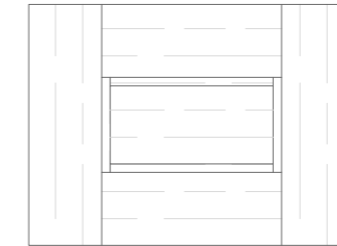

NEW YORK WOOD DOOR:



RED OAK
CABERNET

DOOR STYLE SPECIFICATIONS:

DOOR CONSTRUCTION:

- 5 Piece Wood Door with Recessed Veneer Centre Panel.

MINIMUM SIZE:

- 8"W x 8"H.
- Smaller sizess will be manufactured with reduced rails or be Slab.
- Subject to cabinet minimums.

MAXIMUM SIZE:

- 24"W x 48"H.
- Larger doors will have cross rails. Cross Rails can be removed at no charge but will void warranty.

GLASS DOORS:

- Frame (1-LITE) & Mullions available.

WAINSCOT PANELS:

- Available.
- Edge profile will be defaulted to square.

DOOR MATCH FILLERS/PILASTERS:

- Available.
- Minimum width: 3 1/2"W.

SPECIES AVAILABLE:

- Alder, Clear
- Alder Knotty (Reverse Raised Panel only)
- Cherry
- Maple
- Oak, Red Flat
- Oak, White Flat
- Oak, White Rift
- Walnut

DOOR PROFILE:

DOOR PROFILE

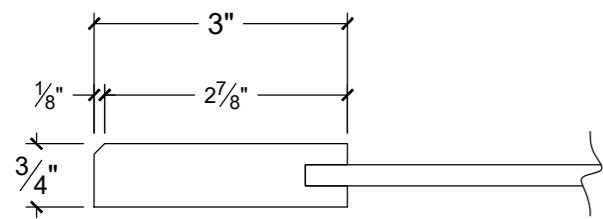

CROSS RAIL PROFILE

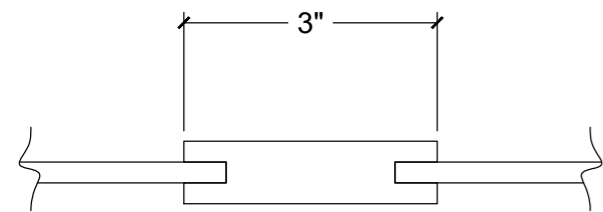

1LITE FRAME RAIL & MULLION PROFILES

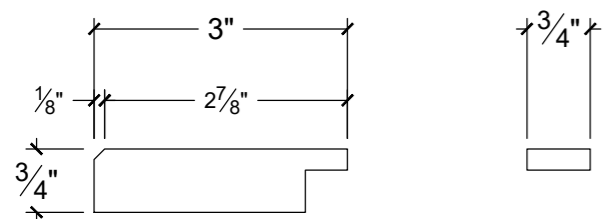

SMALL DRAWER FRONT OPTIONS (6"H):

SLAB

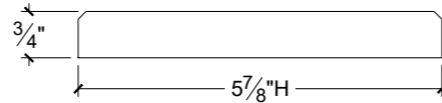
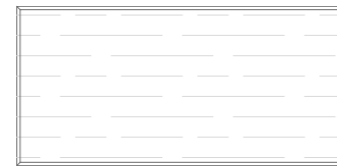

DOOR MATCH

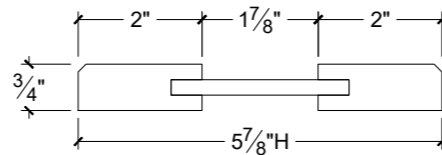

RAIL WIDTHS:

- Vertical rails will match door rails.
- Top & bottom rails are reduced.

MINIMUM SIZE:

- 8"W X 5 7/8"H
- Smaller sizes will be Slab.

LARGE DRAWER FRONT OPTIONS:

SLAB

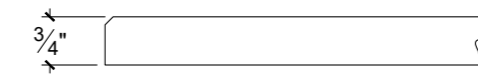

DOOR MATCH

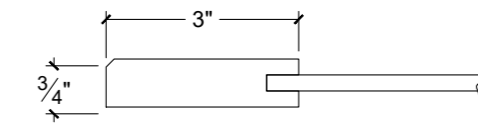
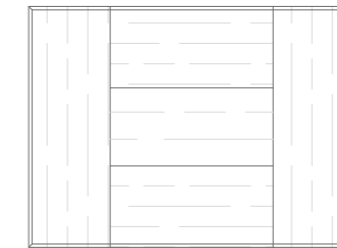

NOVA WOOD DOOR:



MAPLE
CHARCOAL

DOOR STYLE SPECIFICATIONS:

DOOR CONSTRUCTION:

- 5 Piece Wood Door with Recessed Veneer Centre Panel.

MINIMUM SIZE:

- 6 1/2"W x 6 1/2"H.
- Smaller sizes will be manufactured with reduced rails or be Slab.
- Subject to cabinet minimums.

MAXIMUM SIZE:

- 24"W x 48"H.
- Larger doors will have cross rails. Cross Rails can be removed at no charge but will void warranty.

GLASS DOORS:

- Frame (1-LITE) & Mullions available.

WAINSCOT PANELS:

- Available.
- Edge profile will be defaulted to square.

DOOR MATCH FILLERS/PILASTERS:

- Available.
- Minimum width: 3 1/2"W.

SPECIES AVAILABLE:

- Alder, Clear
- Alder Knotty (Reverse Raised Panel only)
- Cherry
- Maple
- Oak, Red Flat
- Oak, White Flat
- Oak, White Rift
- Walnut

DOOR PROFILE:

DOOR PROFILE

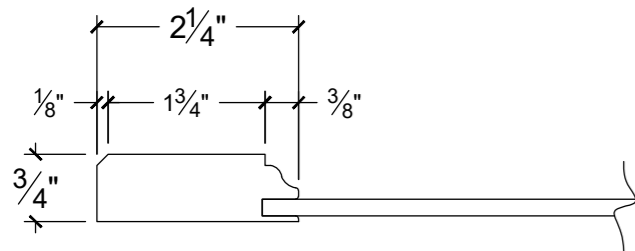

CROSS RAIL PROFILE

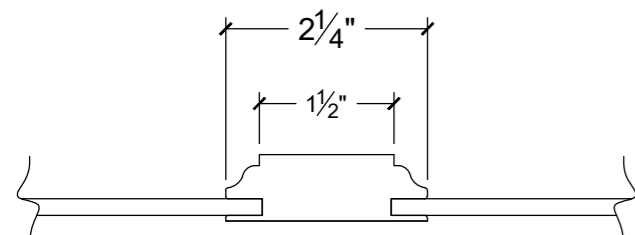

1LITE FRAME RAIL & MULLION PROFILES

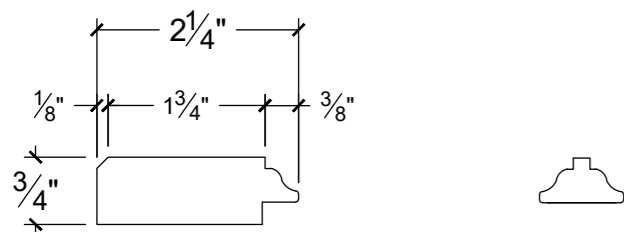

SMALL DRAWER FRONT OPTIONS (6"H):

SLAB

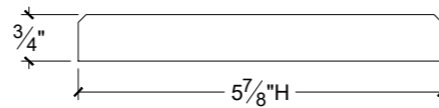

DOOR MATCH

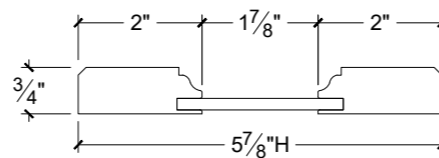

RAIL WIDTHS:

- Vertical rails will match door rails.
- Top & bottom rails are reduced.

MINIMUM SIZE:

- 6 1/2"W x 5 7/8"H
- Smaller sizes will be Slab.

LARGE DRAWER FRONT OPTIONS:

SLAB

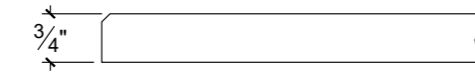

DOOR MATCH

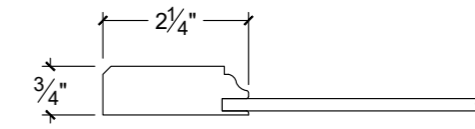
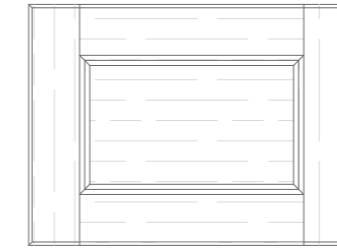

OSTIA WOOD DOOR:



MAPLE
PORTOBELLO &
BLACK GLAZE

DOOR STYLE SPECIFICATIONS:

DOOR CONSTRUCTION:

- 5 Piece Wood Door with Raised Centre Panel.

MINIMUM SIZE:

- 8"W x 8"H.

- Smaller sizes will be manufactured with reduced rails or be Slab.

- Subject to cabinet minimums.

MAXIMUM SIZE:

- 24"W x 48"H.

- Larger doors will have cross rails. Cross Rails can be removed at no charge but will void warranty.

GLASS DOORS:

- 1LITE Frame only.

- Mullions not available.

WAINSCOT PANELS:

- Available.

- Edge profile will be defaulted to square.

DOOR MATCH FILLERS/PILASTERS:

- Available.

- Minimum width: 3 1/2"W.

- Centre panel will be flat veneer.

COMPLIMENTARY DOOR STYLES:

- CAPRI

SPECIES AVAILABLE:

- Alder, Clear
- Alder Knotty
- Cherry
- Maple
- Oak, Red Flat
- Oak, White Flat
- Oak, White Rift
- Walnut

DOOR PROFILE:

DOOR PROFILE

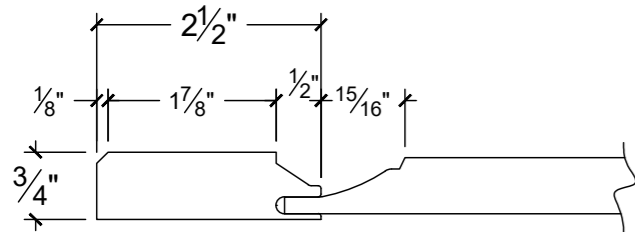

CROSS RAIL PROFILE

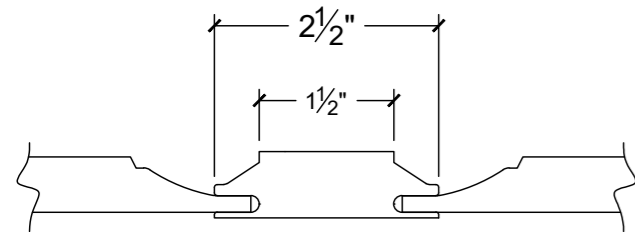

1LITE FRAME RAIL PROFILE

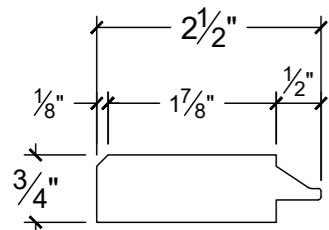

SMALL DRAWER FRONT OPTIONS (6"H):

SLAB

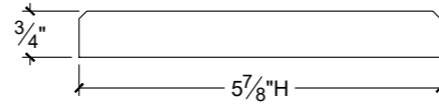
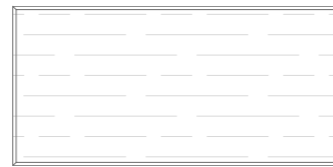

RECESSED

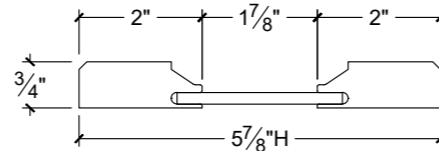
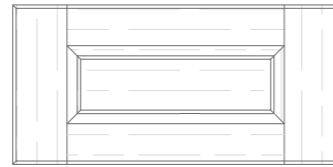

RAIL WIDTHS:

- Vertical rails will match door rails.
- Top & bottom rails are reduced.

MINIMUM SIZE:

- 8"W x 5 7/8"H

- Smaller sizes will be Slab.

LARGE DRAWER FRONT OPTIONS:

SLAB

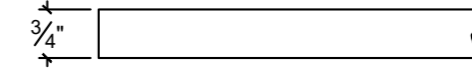
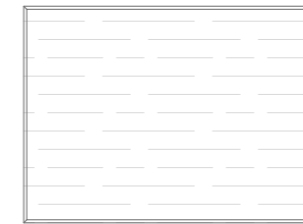

RECESSED

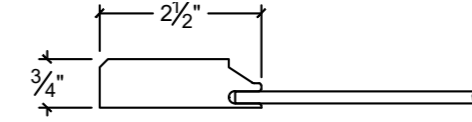
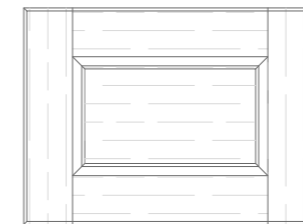

DOOR MATCH

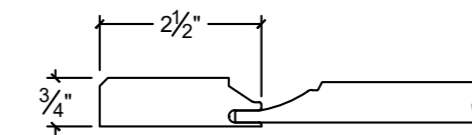
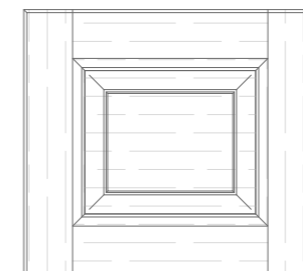

MINIMUM SIZE:

- 9 1/2"W x 9 1/2"H

- Smaller sizes will be Recessed.

PICASSO WOOD DOOR:



OAK, RED FLAT
AZUR

DOOR STYLE SPECIFICATIONS:

DOOR CONSTRUCTION:

- 5 Piece Wood Door with Recessed Veneer Centre Panel.

MINIMUM SIZE:

- 6 1/2"W x 6 1/2"H.
- Smaller sizes will be manufactured with reduced rails or be Slab.
- Subject to cabinet minimums.

MAXIMUM SIZE:

- 24"W x 48"H.
- Larger doors will have cross rails. Cross Rails can be removed at no charge but will void warranty.

GLASS DOORS:

- Frame (1-LITE) & Mullions available.

WAINSCOT PANELS:

- Available.
- Edge profile will be defaulted to square.

DOOR MATCH FILLERS/PILASTERS:

- Available.
- Minimum width: 3 1/2"W.

COMPLIMENTARY DOOR STYLES:

- CLASSIC

SPECIES AVAILABLE:

- Alder, Clear
- Alder Knotty (Reverse Raised Panel only)
- Cherry
- Maple
- Oak, Red Flat
- Oak, White Flat
- Oak, White Rift
- Walnut

DOOR PROFILE:

DOOR PROFILE

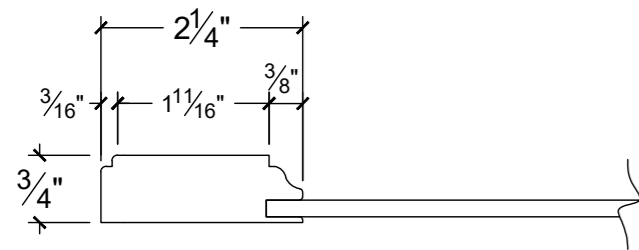

CROSS RAIL PROFILE

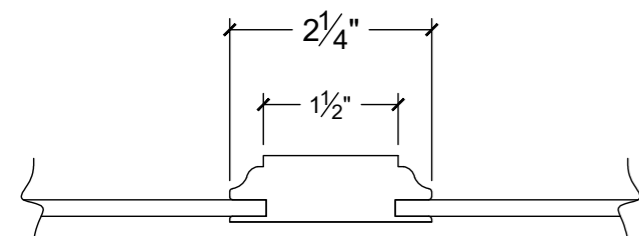

1LITE FRAME RAIL & MULLION PROFILES

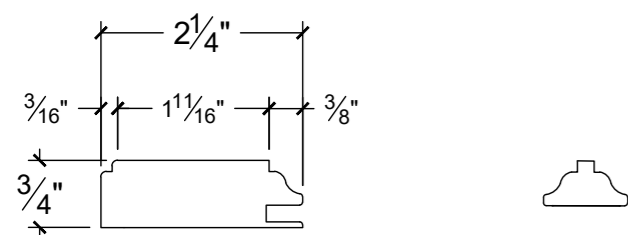

SMALL DRAWER FRONT OPTIONS (6"H):

SLAB

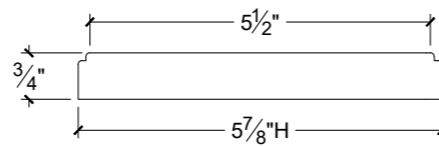
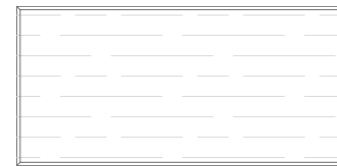

DOOR MATCH

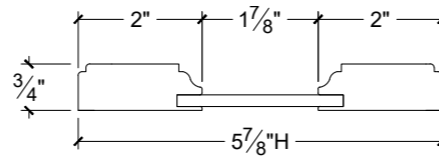

RAIL WIDTHS:

- Vertical rails will match door rails.
- Top & bottom rails are reduced.

MINIMUM SIZE:

- 6 1/2"W x 5 7/8"H
- Smaller sizes will be Slab.

LARGE DRAWER FRONT OPTIONS:

SLAB

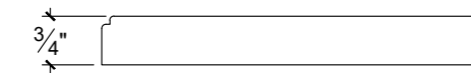

DOOR MATCH

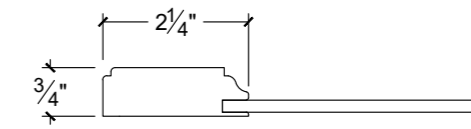
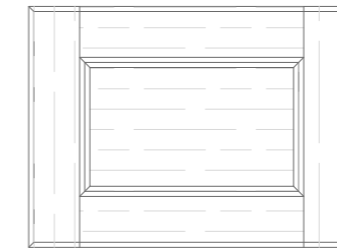

RICHMONT WOOD DOOR:



CHERRY CHOCOLATE

DOOR STYLE SPECIFICATIONS:

DOOR CONSTRUCTION:

- 5 Piece Wood Door with Recessed Veneer Centre Panel.

MINIMUM SIZE:

- 8"W x 8"H.
- Smaller sizes will be manufactured with reduced rails or be Slab.
- Subject to cabinet minimums.

MAXIMUM SIZE:

- 24"W x 48"H.
- Larger doors will have cross rails. Cross Rails can be removed at no charge but will void warranty.

GLASS DOORS:

- Frame (1-LITE) & Mullions available.

WAINSCOT PANELS:

- Available.

DOOR MATCH FILLERS/PILASTERS:

- Available.
- Minimum width: 3"W.

SPECIES AVAILABLE:

- Alder, Clear
- Alder Knotty (Reverse Raised Panel only)
- Cherry
- Maple
- Oak, Red Flat
- Oak, White Flat
- Oak, White Rift
- Walnut

DOOR PROFILE:

DOOR PROFILE

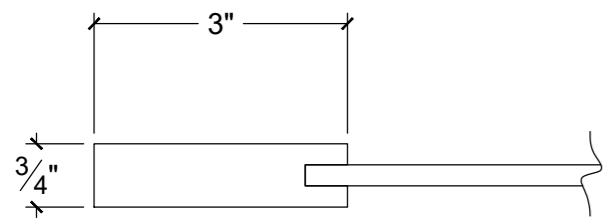

CROSS RAIL PROFILE

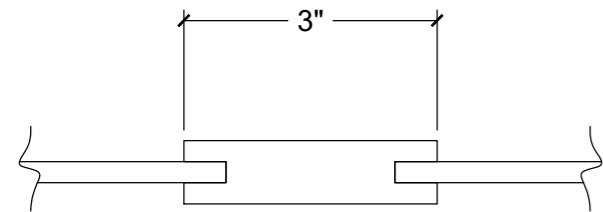

1LITE FRAME RAIL & MULLION PROFILES

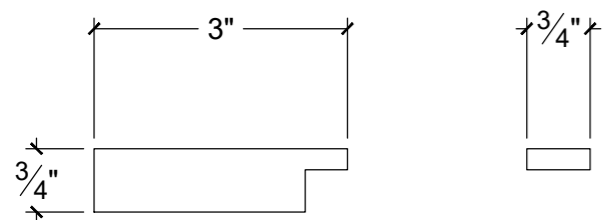

SMALL DRAWER FRONT OPTIONS (6"H):

SLAB

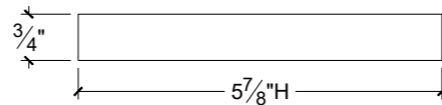
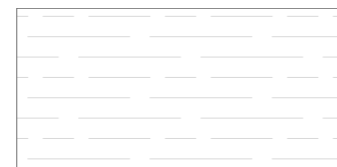

DOOR MATCH

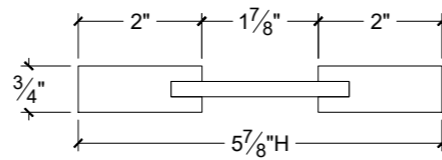
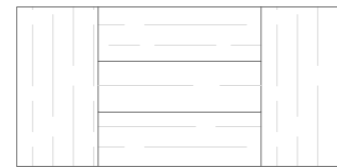

RAIL WIDTHS:

- Vertical rails will match door rails.
- Top & bottom rails are reduced.

MINIMUM SIZE:

- 8"W X 5 7/8"H
- Smaller sizes will be Slab.

LARGE DRAWER FRONT OPTIONS:

SLAB

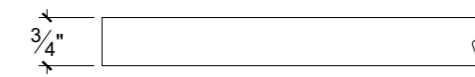
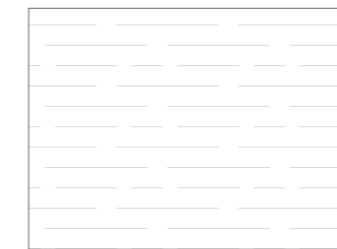

DOOR MATCH

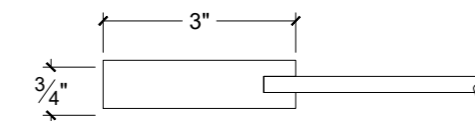
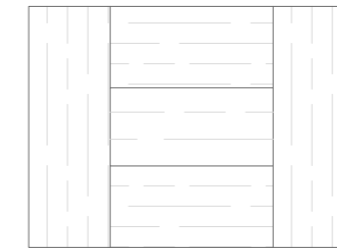

ROSEDALE WOOD DOOR:



MAPLE
AZURE
WITH
BLACK GLAZE

DOOR STYLE SPECIFICATIONS:

DOOR CONSTRUCTION:

- 5 Piece Wood Door with Recessed Veneer Centre Panel

MINIMUM SIZE:

- 8"W x 8"H.
- Smaller sizess will be manufactured with reduced rails or be Slab.
- Subject to cabinet minimums.

MAXIMUM SIZE:

- 24"W x 48"H.
- Larger doors will have cross rails. Cross Rails can be removed at no charge but will void warranty.

GLASS DOORS:

- Frame (1-LITE) & Mullions available.

WAINSCOT PANELS:

- Available.
- Edge profile will be defaulted to square.

DOOR MATCH FILLERS/PILASTERS:

- Available.
- Minimum width: 4 1/2"W.

COMPLIMENTARY DOOR STYLES:

- IMPERIAL

SPECIES AVAILABLE:

- Alder, Clear
- Alder Knotty (Reverse Raised Panel only)
- Cherry
- Maple
- Oak, Red Flat
- Oak, White Flat
- Oak, White Rift
- Walnut

DOOR PROFILE:

DOOR PROFILE

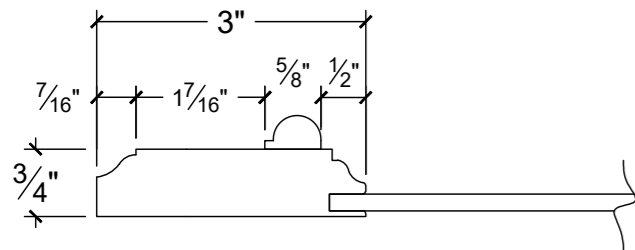

CROSS RAIL PROFILE

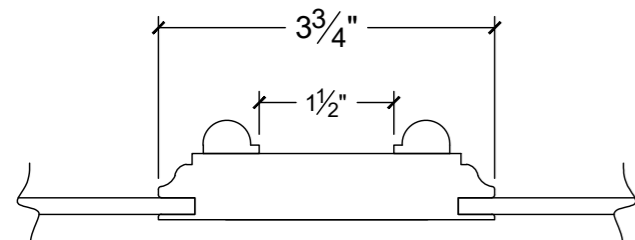

1LITE FRAME RAIL & MULLION PROFILES

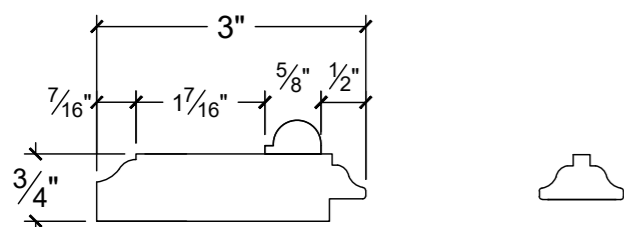

SMALL DRAWER FRONT OPTIONS (6"H):

SLAB

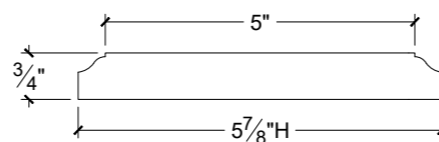
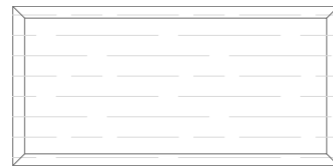

DOOR MATCH

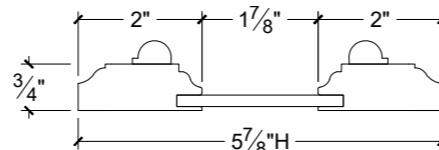
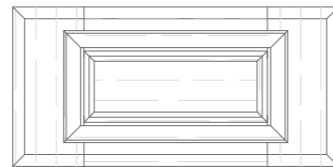

RAIL WIDTHS:

- Vertical rails will match door rails.
- Top & bottom rails are reduced.

MINIMUM SIZE:

- 8"W x 5 7/8"H
- Smaller sizes will be Slab.

LARGE DRAWER FRONT OPTIONS:

SLAB

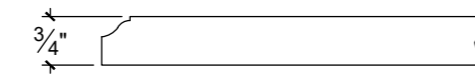
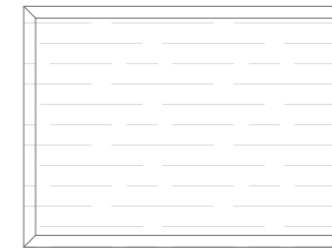

DOOR MATCH

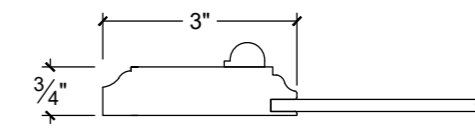
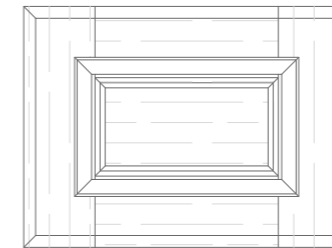

ROYAL WOOD DOOR:



OAK, RED FLAT
MASALA

DOOR STYLE SPECIFICATIONS:

DOOR CONSTRUCTION:

- 5 Piece Wood Door with Raised Centre Panel.

MINIMUM SIZE:

- 7 1/2"W x 7 1/2"H.

- Smaller sizes will be manufactured with reduced rails or be Slab.

- Subject to cabinet minimums.

MAXIMUM SIZE:

- 24"W x 48"H.

- Larger doors will have cross rails. Cross Rails can be removed at no charge but will void warranty.

GLASS DOORS:

- Frame (1-LITE) & Mullions available.

WAINSCOT PANELS:

- Available.

- Edge profile will be defaulted to square.

DOOR MATCH FILLERS/PILASTERS:

- Available.

- Minimum width: 3 1/2"W.

- Centre panel will be flat veneer.

COMPLIMENTARY DOOR STYLES:

- PICASSO

SPECIES AVAILABLE:

- Alder, Clear
- Alder Knotty
- Maple
- Oak, Red Flat
- Oak, White Flat
- Oak, White Rift
- Walnut

DOOR PROFILE:

DOOR PROFILE

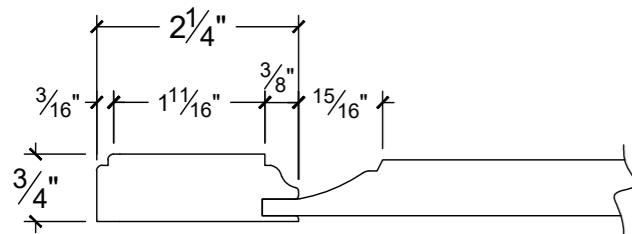

CROSS RAIL PROFILE

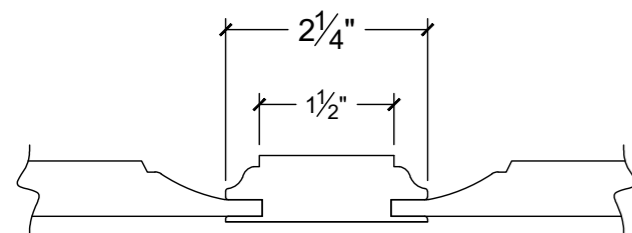

1LITE FRAME RAIL & MULLION PROFILES

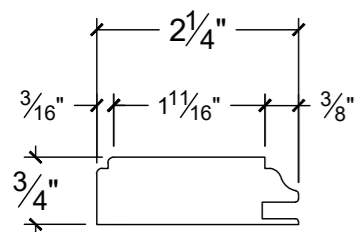

SMALL DRAWER FRONT OPTIONS (6"H):

SLAB

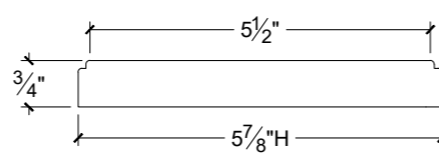

RECESSED

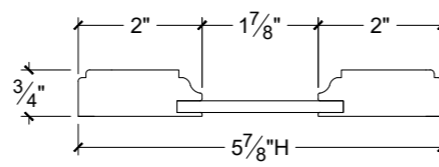

RAIL WIDTHS:

- Vertical rails will match door rails.
- Top & bottom rails are reduced.

MINIMUM SIZE:

- 7 1/2"W x 5 7/8"H

- Smaller sizes will be Slab.

LARGE DRAWER FRONT OPTIONS:

SLAB

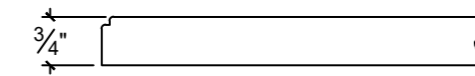

RECESSED

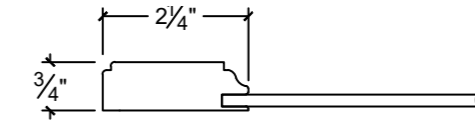
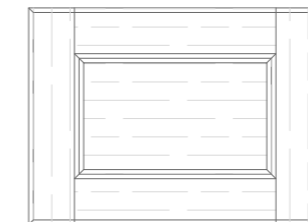

DOOR MATCH

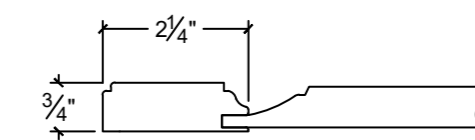
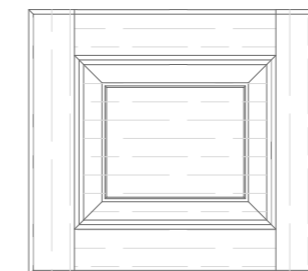

MINIMUM SIZE:

- 8 1/4"W x 8 1/4"H

- Smaller sizes will be Recessed.

SHAKER WOOD DOOR:



KNOTTY ALDER
MUSKOKA

DOOR STYLE SPECIFICATIONS:

DOOR CONSTRUCTION:

- 5 Piece Wood Door with Recessed Veneer Centre Panel.

MINIMUM SIZE:

- 6 1/2"W x 6 1/2"H.
- Smaller sizes will be manufactured with reduced rails or be Slab.
- Subject to cabinet minimums.

MAXIMUM SIZE:

- 24"W x 48"H.
- Larger doors will have cross rails. Cross Rails can be removed at no charge but will void warranty.

GLASS DOORS:

- Frame (1-LITE) & Mullions available.

WAINSCOT PANELS:

- Available.

DOOR MATCH FILLERS/PILASTERS:

- Available.
- Minimum width: 3"W.

SPECIES AVAILABLE:

- Alder, Clear
- Alder Knotty (Reverse Raised Panel only)
- Cherry
- Maple
- Oak, Red Flat
- Oak, White Flat
- Oak, White Rift
- Walnut

DOOR PROFILE:

DOOR PROFILE

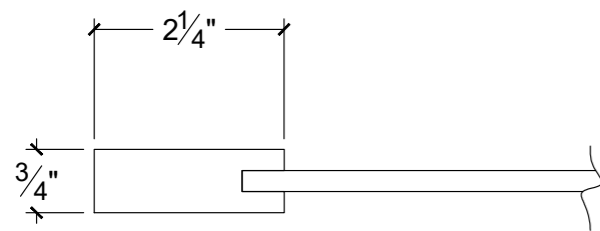

CROSS RAIL PROFILE

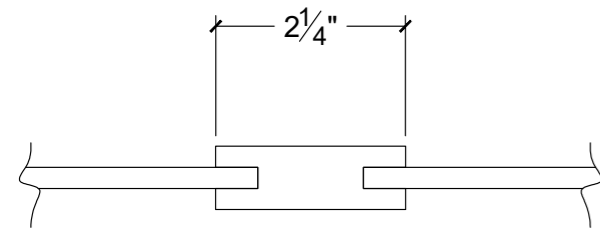

1LITE FRAME RAIL & MULLION PROFILES

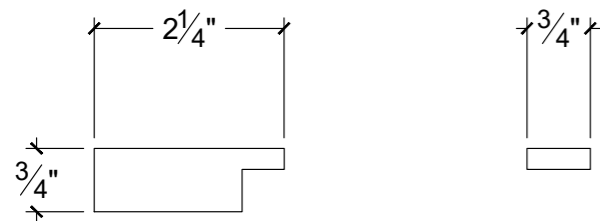

SMALL DRAWER FRONT OPTIONS (6"H):

SLAB

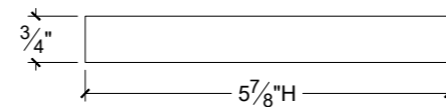
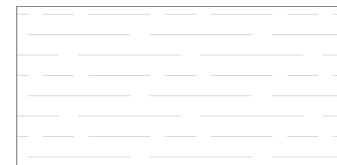

DOOR MATCH

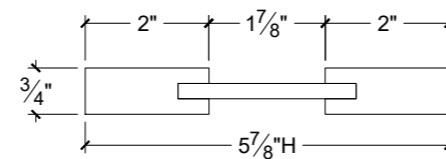

RAIL WIDTHS:

- Vertical rails will match door rails.
- Top & bottom rails are reduced.

MINIMUM SIZE:

- 6 1/2"W X 5 7/8"H
- Smaller sizes will be Slab.

LARGE DRAWER FRONT OPTIONS:

SLAB

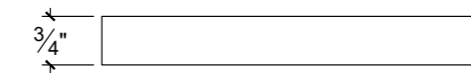
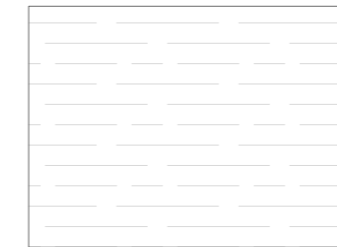

DOOR MATCH

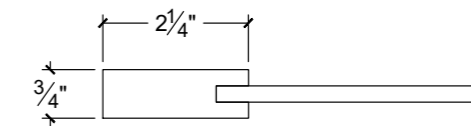
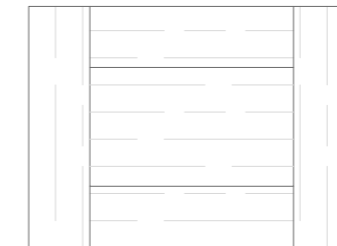

SOUTHBROOK WOOD DOOR:



WALNUT GALAXY

DOOR STYLE SPECIFICATIONS:

DOOR CONSTRUCTION:

- 5 Piece Wood Door with Recessed Veneer Centre Panel.

MINIMUM SIZE:

- 8"W x 8"H.
- Smaller sizess will be manufactured with reduced rails or be Slab.
- Subject to cabinet minimums.

MAXIMUM SIZE:

- 24"W x 48"H.
- Larger doors will have cross rails. Cross Rails can be removed at no charge but will void warranty.

GLASS DOORS:

- Frame (1-LITE) & Mullions available.

WAINSCOT PANELS:

- Available.

DOOR MATCH FILLERS/PILASTERS:

- Available.
- Minimum width: 3 1/2"W.

SPECIES AVAILABLE:

- Alder, Clear
- Alder Knotty (Reverse Raised Panel only)
- Cherry
- Maple
- Oak, Red Flat
- Oak, White Flat
- Oak, White Rift
- Walnut

DOOR PROFILE:

DOOR PROFILE

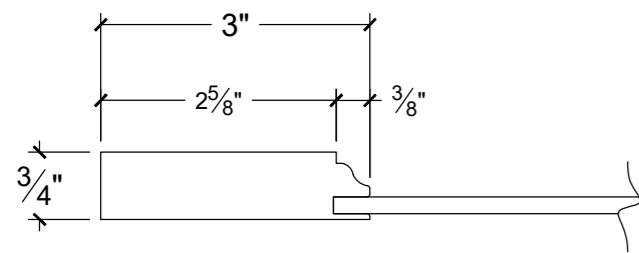

CROSS RAIL PROFILE

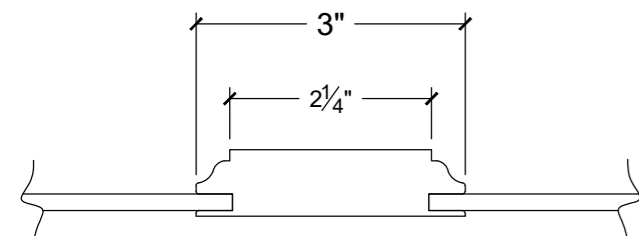

1LITE FRAME RAIL & MULLION PROFILES

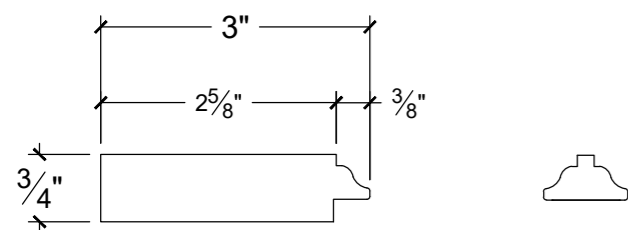

SMALL DRAWER FRONT OPTIONS (6"H):

SLAB

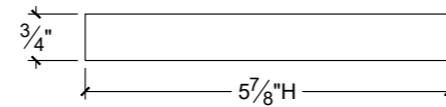
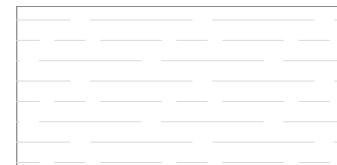

DOOR MATCH

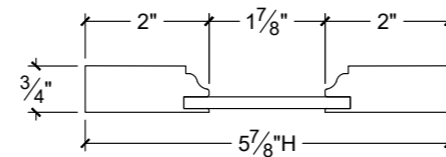
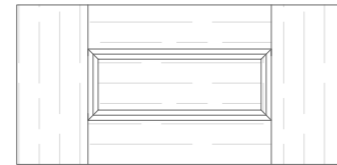

RAIL WIDTHS:

- Vertical rails will match door rails.
- Top & bottom rails are reduced.

MINIMUM SIZE:

- 8"W x 5 7/8"H
- Smaller sizes will be Slab.

LARGE DRAWER FRONT OPTIONS:

SLAB

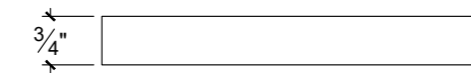
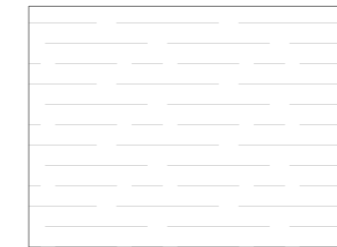

DOOR MATCH

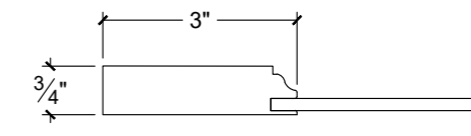
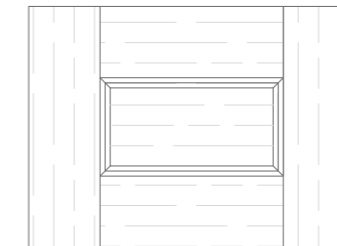

STERLING WOOD DOOR:



MAPLE
CABERNET

DOOR STYLE SPECIFICATIONS:

DOOR CONSTRUCTION:

- 5 Piece Wood Door with Recessed Veneer Centre Panel.

MINIMUM SIZE:

- 8"W x 8"H.
- Smaller sizes will be manufactured with reduced rails or be Slab.
- Subject to cabinet minimums.

MAXIMUM SIZE:

- 24"W x 48"H.
- Larger doors will have cross rails. Cross Rails can be removed at no charge but will void warranty.

GLASS DOORS:

- 1LITE Frame only.
- Mullions not available.

WAINSCOT PANELS:

- Available.

DOOR MATCH FILLERS/PILASTERS:

- Available.
- Minimum width: 3 1/2"W.

COMPLIMENTARY DOOR STYLES:

- ALBAN
- KINGSTON (MDF Door).

SPECIES AVAILABLE:

- Alder, Clear
- Alder Knotty (Reverse Raised Panel only)
- Cherry
- Maple
- Oak, Red Flat
- Oak, White Flat
- Oak, White Rift
- Walnut

DOOR PROFILE:

DOOR PROFILE

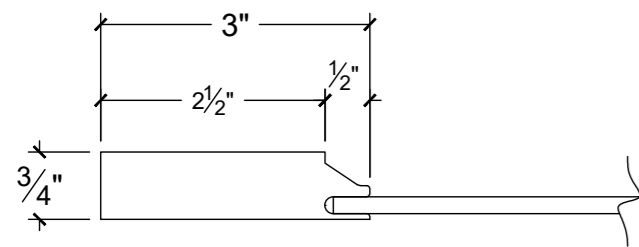

CROSS RAIL PROFILE

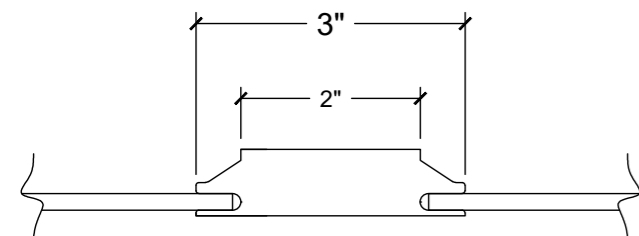

1LITE FRAME RAIL PROFILE

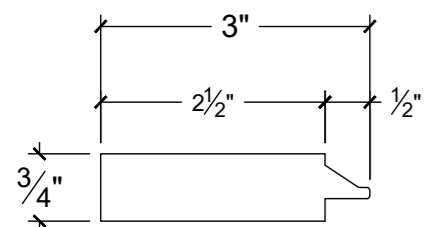

SMALL DRAWER FRONT OPTIONS (6"H):

SLAB

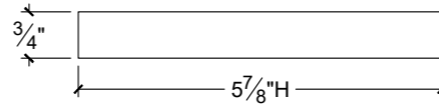
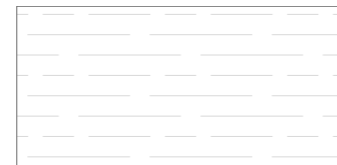

DOOR MATCH

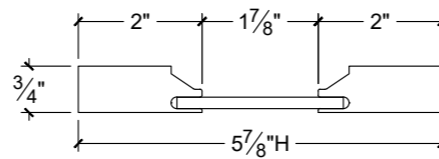
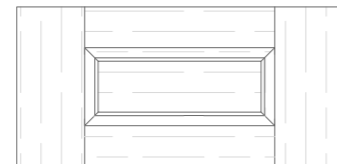

RAIL WIDTHS:

- Vertical rails will match door rails.
- Top & bottom rails are reduced.

MINIMUM SIZE:

- 8"W x 5 7/8"H
- Smaller sizes will be Slab.

LARGE DRAWER FRONT OPTIONS:

SLAB

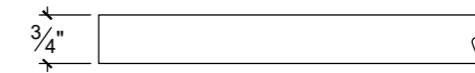
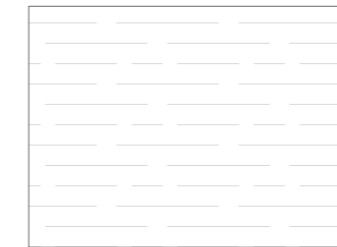

DOOR MATCH

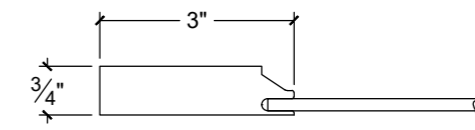
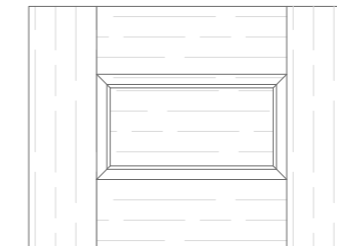

SYMPHONY WOOD DOOR:



MAPLE
EBONY

DOOR STYLE SPECIFICATIONS:

DOOR CONSTRUCTION:

- 5 Piece Wood Door with Raised Centre Panel.

MINIMUM SIZE:

- 9"W x 9"H.

- Smaller sizes will be manufactured with reduced rails or be Slab.

- Subject to cabinet minimums.

MAXIMUM SIZE:

- 24"W x 48"H.

- Larger doors will have cross rails. Cross Rails can be removed at no charge but will void warranty.

GLASS DOORS:

- Frame (1-LITE) & Mullions available.

WAINSCOT PANELS:

- Available.

DOOR MATCH FILLERS/PILASTERS:

- Available.

- Minimum width: 3 1/2"W.

- Centre panel will be flat veneer.

SPECIES AVAILABLE:

- Alder, Clear
- Alder Knotty
- Maple
- Oak, Red Flat
- Oak, White Flat
- Oak, White Rift
- Walnut

DOOR PROFILE:

DOOR PROFILE

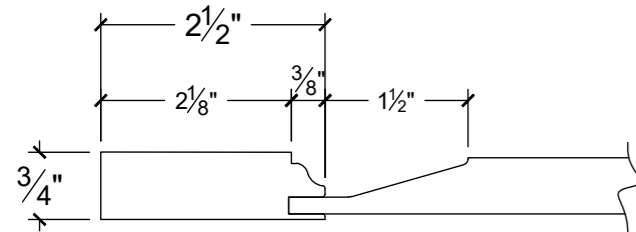

CROSS RAIL PROFILE

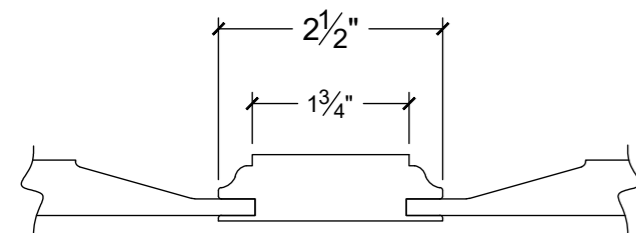

1LITE FRAME RAIL & MULLION PROFILES

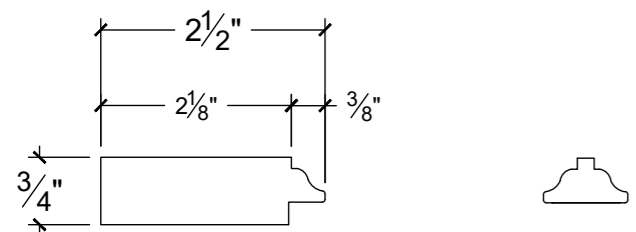

SMALL DRAWER FRONT OPTIONS (6"H):

SLAB

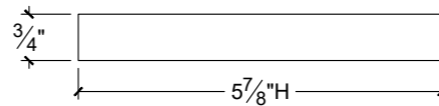
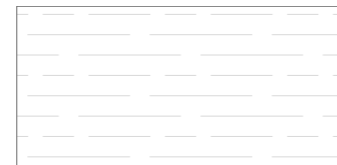

RECESSED

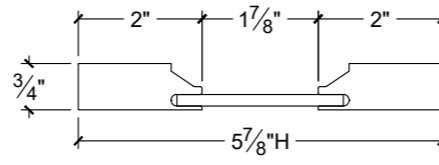

RAIL WIDTHS:

- Vertical rails will match door rails.
- Top & bottom rails are reduced.

MINIMUM SIZE:

- 9"W x 5 7/8"H

- Smaller sizes will be Slab.

LARGE DRAWER FRONT OPTIONS:

SLAB

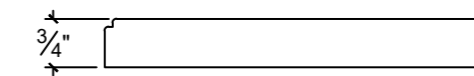

RECESSED

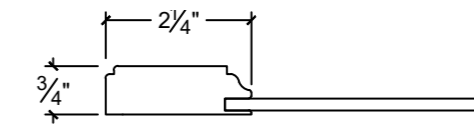

DOOR MATCH

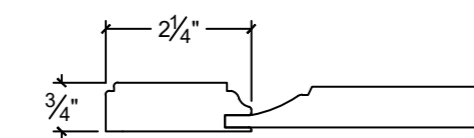
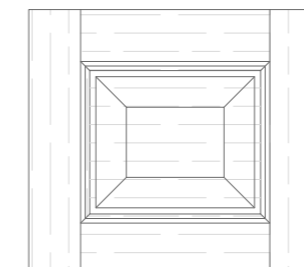

MINIMUM SIZE:

- 8 1/4"W x 8 1/4"H

- Smaller sizes will be Recessed.

URBAN WOOD DOOR:

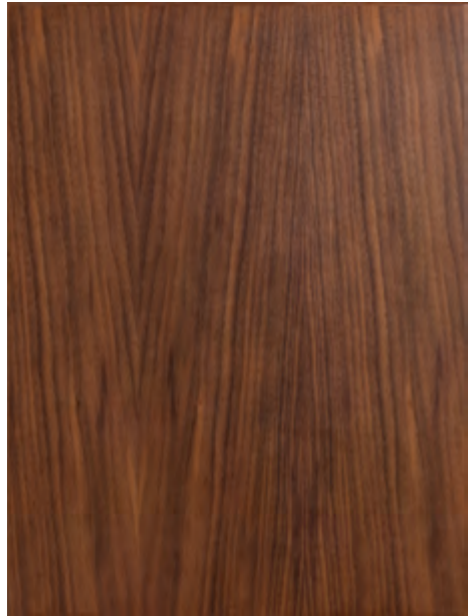

WALNUT
NATURAL

DOOR STYLE SPECIFICATIONS:

DOOR CONSTRUCTION:

- Wood Veneered Panel door with MDF core.

MINIMUM SIZE:

- 3"W x 3"H.

- Subject to cabinet minimums.

MAXIMUM SIZE:

- 24"W x 72"H.

- Larger doors are available but will void warranty.

GLASS DOORS:

- 1LITE Frame only.

- Mullions not available.

WAINSCOT PANELS:

- Not available.

DOOR MATCH FILLERS/PILASTERS:

- Not available.

GRAIN DIRECTION:

- Vertical Grain by default.

- Horizontal Grain is available as an upgrade.

GRAIN-MATCHING:

- Grain-Matching is available as an upgrade.

- Grain-Matching applies to Cabinet Fronts only.

- Fillers, Panels, Pilasters, etc. will not be matched.

- Grain-Matching is limited to the size of a veneered panel (48"W x 96"H or 96"W x 48"H).

- Floor plans & Elevation drawings are required.

SPECIES AVAILABLE:

- Alder, Clear
- Maple
- Oak, Red Flat
- Oak, White Flat
- Oak, White Rift
- Walnut

DOOR PROFILE:

DOOR PROFILE

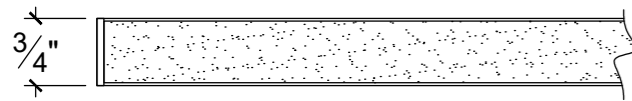

1LITE FRAME RAIL PROFILE

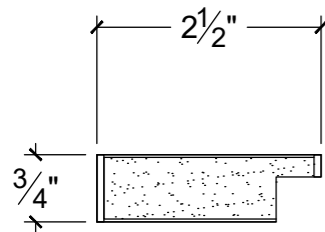

SMALL DRAWER FRONT OPTIONS (6"H):

DOOR MATCH

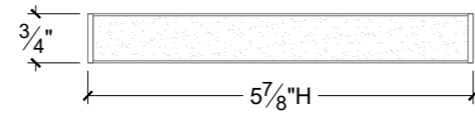
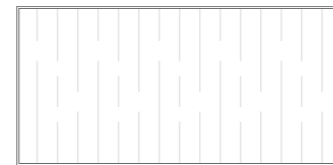

LARGE DRAWER FRONT OPTIONS:

DOOR MATCH

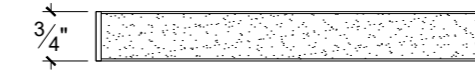

MDF DOORS

MDF DOORS

BASAL MDF DOOR



MDF
WROUGHT IRON

DOOR STYLE SPECIFICATIONS:

DOOR CONSTRUCTION:

-1 Piece MDF.

MINIMUM SIZE:

-3"W x 3"H.

-Subject to cabinet minimums.

MAXIMUM SIZE:

-24"W x 72"H.

-Larger doors are available but will void warranty.

GLASS DOORS:

-1LITE Frame Rail & Mullions available.

WAINSCOT PANELS:

-Not available.

DOOR MATCH FILLERS/PILASTERS:

-Not available.

SPECIES AVAILABLE:

-MDF

DOOR PROFILE:

DOOR PROFILE

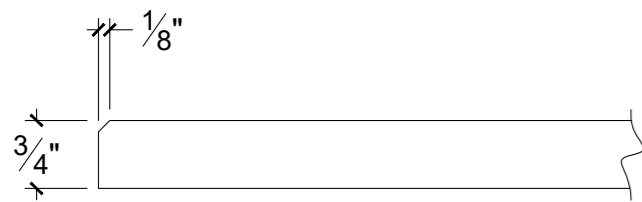

1LITE FRAME RAIL & MULLION PROFILE

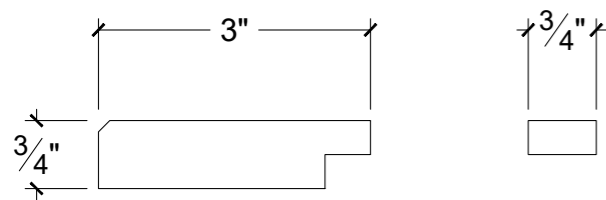

SMALL DRAWER FRONT OPTIONS (6"H):

SLAB

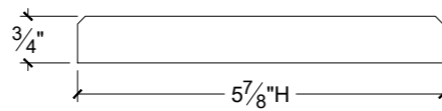
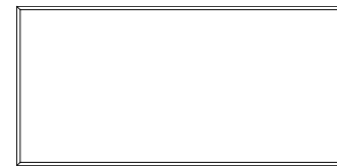

LARGE DRAWER FRONT OPTIONS:

SLAB

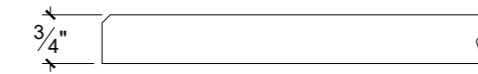
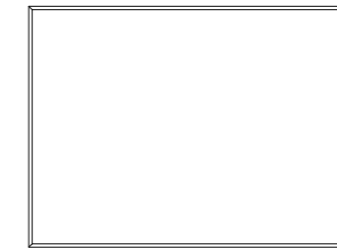

BELLA MDF DOOR



MDF
PISTACHIO

DOOR STYLE SPECIFICATIONS:

DOOR CONSTRUCTION:

-1 Piece MDF.

MINIMUM SIZE:

-8"W x 8"H.

-Smaller sizes will be manufactured with 3/4" (Recessed) Profile only.

-Subject to cabinet minimums.

MAXIMUM SIZE:

-24"W x 72"H.

-Larger doors are available but will void warranty.

GLASS DOORS:

-1LITE Frames only.

-Mullions not available.

WAINSCOT PANELS:

-Not available.

DOOR MATCH FILLERS/PILASTERS:

-Not available.

-Suggested alternative: CARINA.

COMPLIMENTARY DOOR STYLES:

-CARINA.

SPECIES AVAILABLE:

-MDF

DOOR PROFILE:

DOOR PROFILE

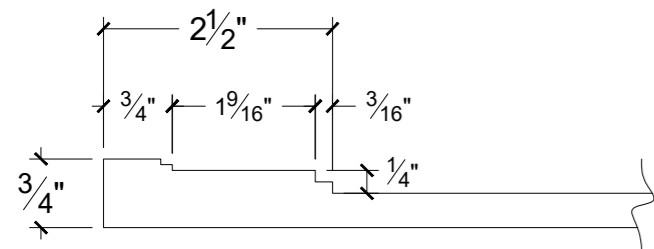

1LITE FRAME RAIL PROFILE

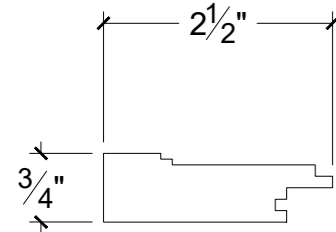

SMALL DRAWER FRONT OPTIONS (6"H):

SLAB

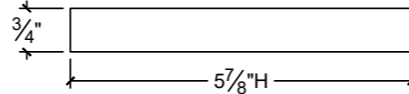
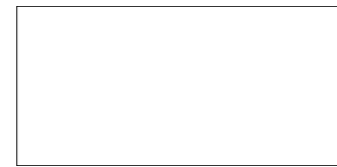

RECESSED

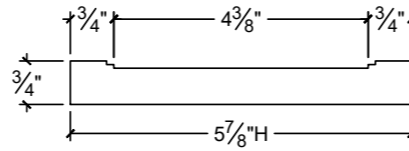
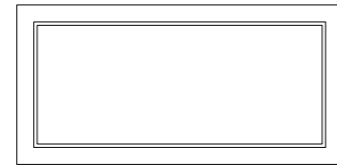

DOOR MATCH

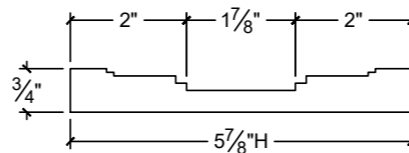
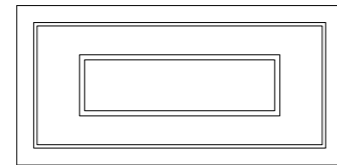

RAIL WIDTHS:

-Vertical rails will match door rails.

-Top & bottom rails are reduced.

MINIMUM SIZE:

-8"W x 5 7/8"H.

-Smaller sizes will be manufactured with 3/4" (Recessed) Profile only.

LARGE DRAWER FRONT OPTIONS:

SLAB

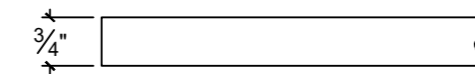
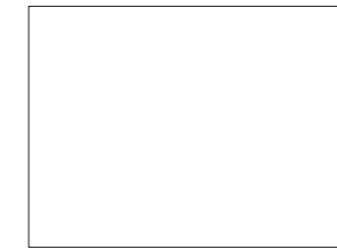

RECESSED

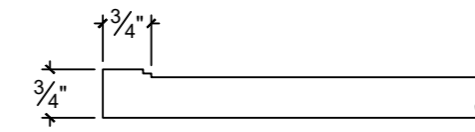
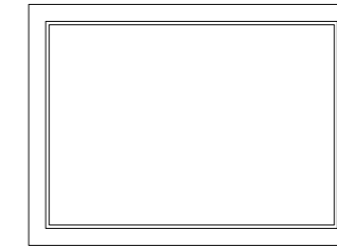

DOOR MATCH

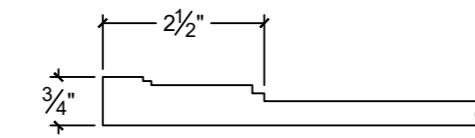
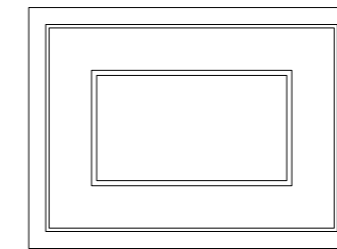

CARINA MDF DOOR



MDF
SILENT NIGHT

DOOR STYLE SPECIFICATIONS:

DOOR CONSTRUCTION:

-1 Piece MDF.

MINIMUM SIZE:

-3"W x 3"H.

-Smaller sizes will be manufactured with 3/4" (Recessed) Profile only.

-Subject to cabinet minimums.

MAXIMUM SIZE:

-24"W x 72"H.

-Larger doors are available but will void warranty.

GLASS DOORS:

-1LITE Frame Rail & Mullions available.

WAINSCOT PANELS:

-Not available.

DOOR MATCH FILLERS/PILASTERS:

-Available.

-Minimum width: 3"W.

COMPLIMENTARY DOOR STYLES:

-BELLA.

SPECIES AVAILABLE:

-MDF

DOOR PROFILE:

DOOR PROFILE

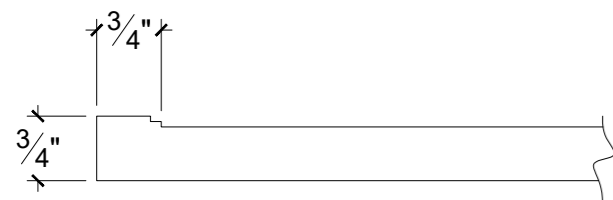

1LITE FRAME RAIL & MULLION PROFILE

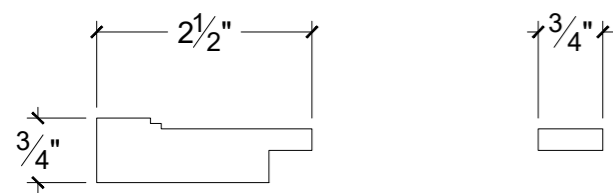

SMALL DRAWER FRONT OPTIONS (6"H):

SLAB

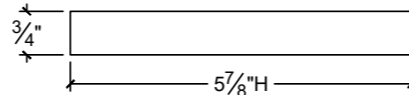

DOOR MATCH

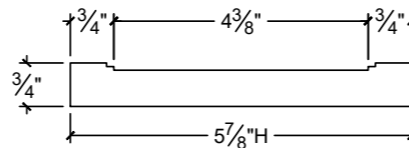
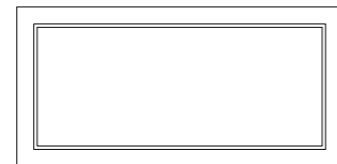

MINIMUM SIZE:

-3"W x 3"H.

-Smaller sizes will be Slab.

LARGE DRAWER FRONT OPTIONS:

SLAB

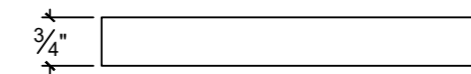
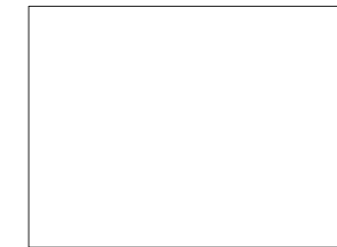

DOOR MATCH

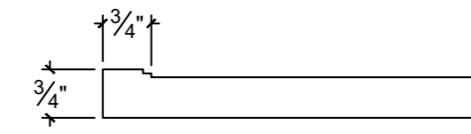
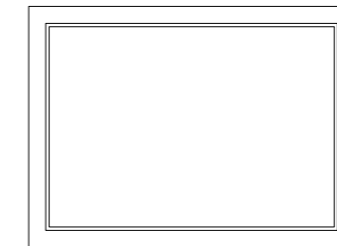

DUBLIN MDF DOOR



MDF
CLOUD WHITE

DOOR STYLE SPECIFICATIONS:

DOOR CONSTRUCTION:

-1 Piece MDF.

MINIMUM SIZE:

-8"W x 8"H.

-Smaller sizes will be manufactured with reduced Rails.

-Subject to cabinet minimums.

MAXIMUM SIZE:

-24"W x 48"H.

-Larger doors will have cross rails. Cross Rails can be removed at no charge.

GLASS DOORS:

-1LITE Frame Rail & Mullions available.

WAINSCOT PANELS:

-Available.

DOOR MATCH FILLERS/PILASTERS:

-Available.

-Minimum width: 3"W.

SPECIES AVAILABLE:

-MDF

DOOR PROFILE:

DOOR PROFILE

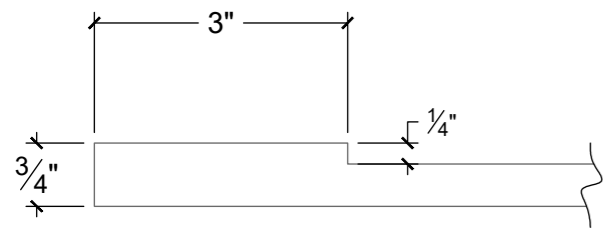

CROSS RAIL PROFILE

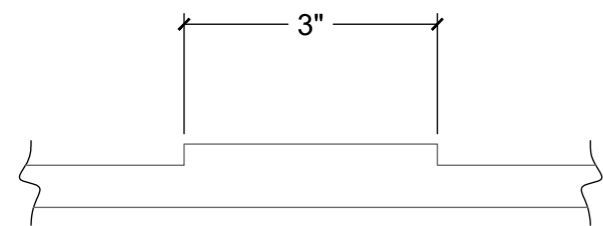

1LITE FRAME RAIL & MULLION PROFILES

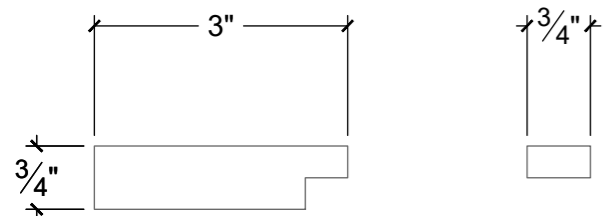

SMALL DRAWER FRONT OPTIONS (6"H):

SLAB

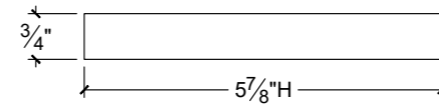
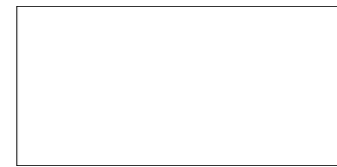

DOOR MATCH

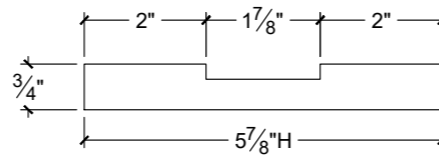
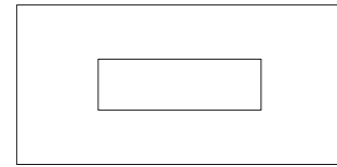

MINIMUM SIZE:

-8"W x 5 7/8"H.

-Smaller sizes will be Slab.

LARGE DRAWER FRONT OPTIONS:

SLAB

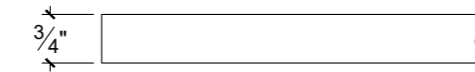
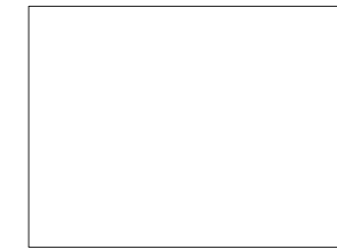

DOOR MATCH

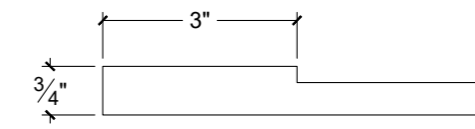
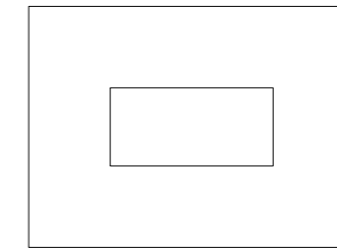

EMPIRE MDF DOOR



MDF
AMAZONAS

DOOR STYLE SPECIFICATIONS:

DOOR CONSTRUCTION:

-1 Piece MDF.

MINIMUM SIZE:

-7"W x 7"H.

-Smaller sizes will be manufactured with reduced Rails.

-Subject to cabinet minimums.

MAXIMUM SIZE:

-24"W x 48"H.

-Larger doors will have cross rails. Cross Rails can be removed at no charge.

GLASS DOORS:

-1LITE Frames only.

-Mullions not available.

WAINSCOT PANELS:

- Available.

DOOR MATCH FILLERS/PILASTERS:

- Available.

-Minimum width: 3 1/2"W.

SPECIES AVAILABLE:

-MDF

DOOR PROFILE:

DOOR PROFILE

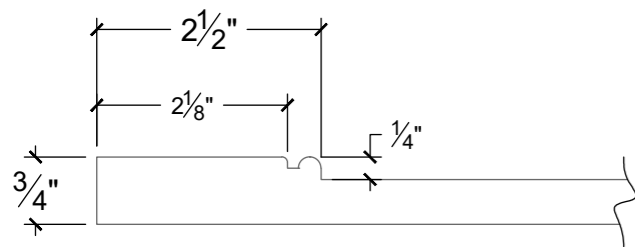

CROSS RAIL PROFILE

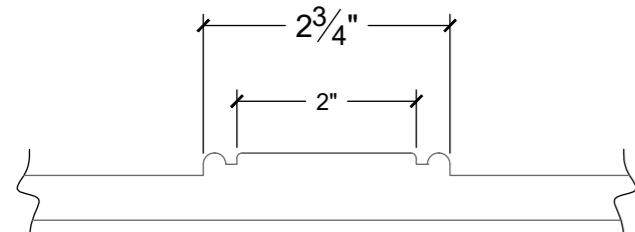

1LITE FRAME RAIL PROFILE

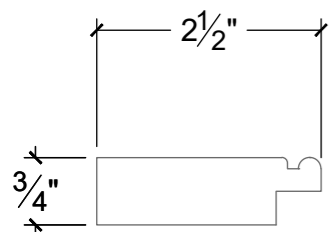

SMALL DRAWER FRONT OPTIONS (6"H):

SLAB

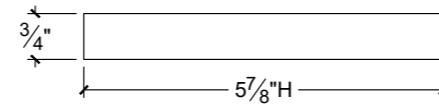

DOOR MATCH

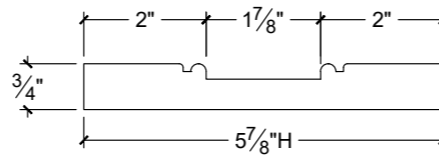
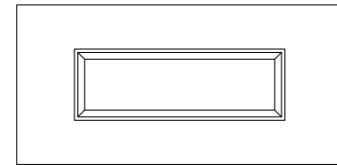

MINIMUM SIZE:

-7"W x 5 7/8"H.

-Smaller sizes will be Slab.

LARGE DRAWER FRONT OPTIONS:

SLAB

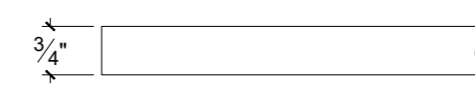

DOOR MATCH

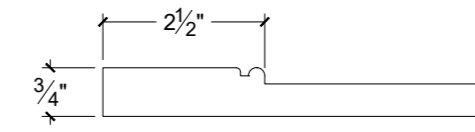
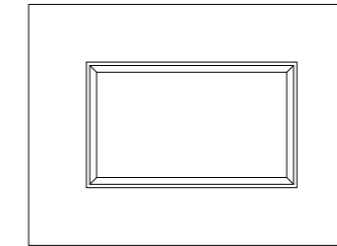

EXECUTIVE MDF DOOR



MDF
ROCKPORT GRAY
& BLACK GLAZE

DOOR STYLE SPECIFICATIONS:

DOOR CONSTRUCTION:

-1 Piece MDF.

MINIMUM SIZE:

-10"W x 10"H.

-Smaller sizes will be manufactured with reduced Rails.

-Subject to cabinet minimums.

MAXIMUM SIZE:

-24"W x 48"H.

-Larger doors will have cross rails. Cross Rails can be removed at no charge.

GLASS DOORS:

-1LITE Frame Rail & Mullions available.

WAINSCOT PANELS:

-Available.

-Edge profile will be defaulted to square.

DOOR MATCH FILLERS/PILASTERS:

-Available.

-Minimum width: 3 1/2"W.

-Centre panel will be recessed.

-Edge profile will be defaulted to square.

SPECIES AVAILABLE:

-MDF

DOOR PROFILE:

DOOR PROFILE

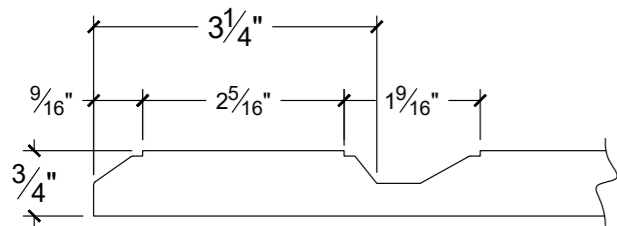

CROSS RAIL PROFILE

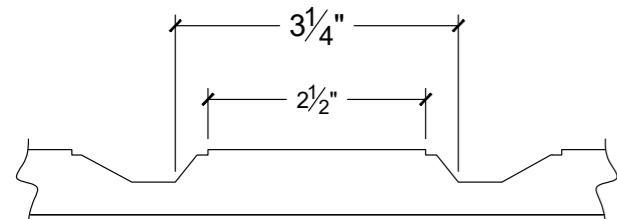

1LITE FRAME RAIL & MULLION PROFILES

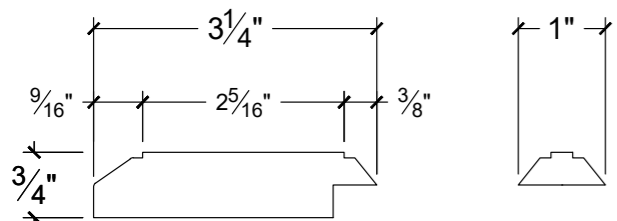

SMALL DRAWER FRONT OPTIONS (6"H):

SLAB

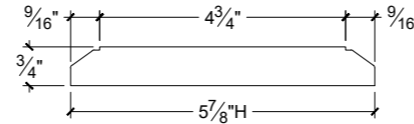
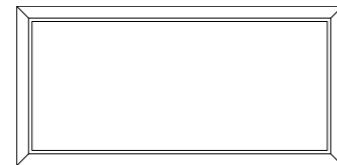

RECESSED

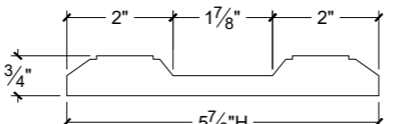
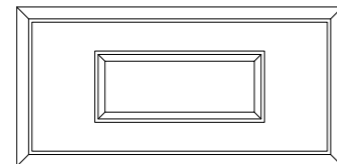

RAIL WIDTHS:

-Vertical rails will match door rails.

-Top & bottom rails are reduced.

MINIMUM SIZE:

-10"W x 5 7/8"H.

-Smaller sizes will be manufactured as Slab.

LARGE DRAWER FRONT OPTIONS:

SLAB

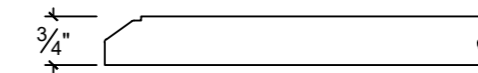
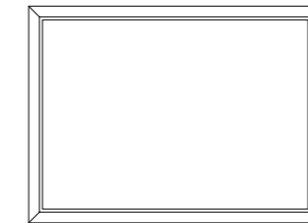

RECESSED

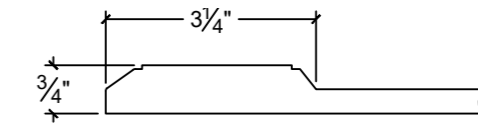
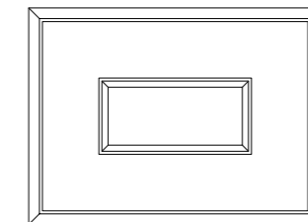

DOOR MATCH

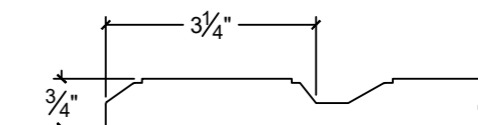
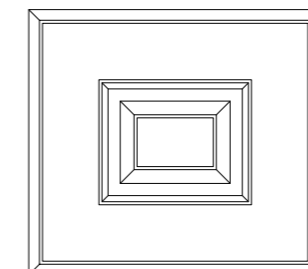

MINIMUM SIZE:

-10"W x 10"H

-Smaller sizes will be Recessed.

KINGSTON MDF DOOR



MDF
LAKESHORE BLUE

DOOR STYLE SPECIFICATIONS:

DOOR CONSTRUCTION:

-1 Piece MDF.

MINIMUM SIZE:

-8"W x 8"H.

-Smaller sizes will be manufactured with reduced Rails.

-Subject to cabinet minimums.

MAXIMUM SIZE:

-24"W x 48"H.

-Larger doors will have cross rails. Cross Rails can be removed at no charge.

GLASS DOORS:

-1LITE Frame only.

-Mullions not available.

WAINSCOT PANELS:

-Available.

DOOR MATCH FILLERS/PILASTERS:

-Available.

-Minimum width: 3 1/2"W.

COMPLIMENTARY DOOR STYLES:

-STERLING (Wood Door)

SPECIES AVAILABLE:

-MDF

DOOR PROFILE:

DOOR PROFILE

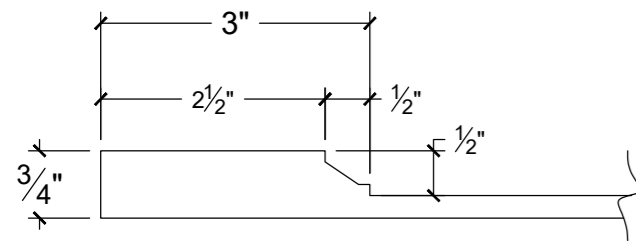

CROSS RAIL PROFILE

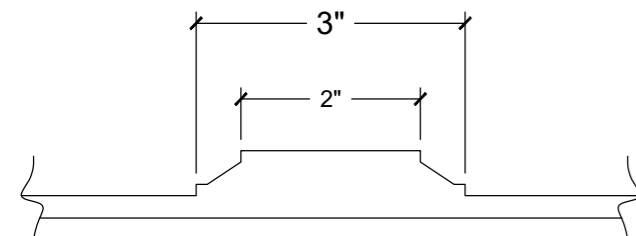

1LITE FRAME RAIL PROFILE

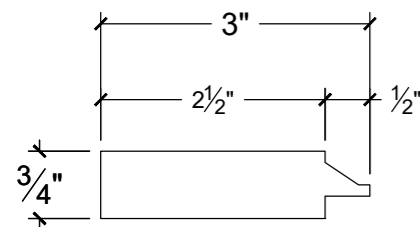

SMALL DRAWER FRONT OPTIONS (6"H):

SLAB

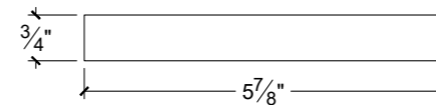
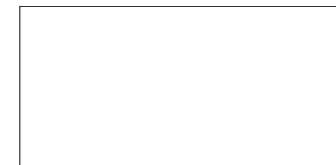

DOOR MATCH

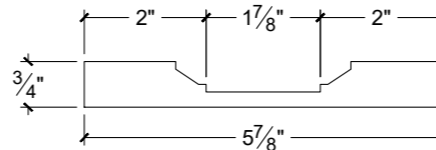
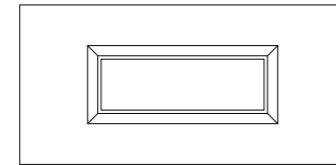

MINIMUM SIZE:

-8"W x 5 7/8"H.

-Smaller sizes will be Slab.

LARGE DRAWER FRONT OPTIONS:

SLAB

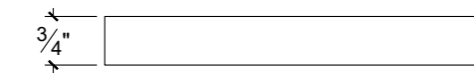
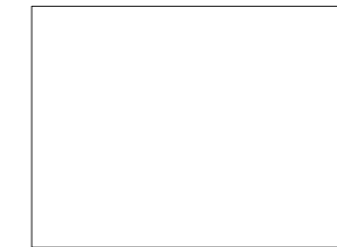

DOOR MATCH

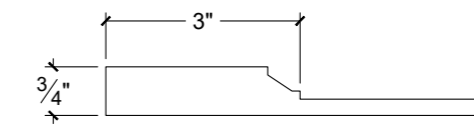
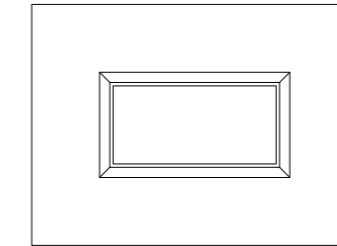

LOFT MDF DOOR



DOOR STYLE SPECIFICATIONS:

DOOR CONSTRUCTION:

-1 Piece MDF.

MINIMUM SIZE:

-3"W x 3"H.

-Smaller sizes will be manufactured as Slab only.

-Subject to cabinet minimums.

MAXIMUM SIZE:

-24"W x 72"H.

-Larger doors are available but will void warranty.

GLASS DOORS:

-1LITE Frame Rail & Mullions available.

WAINSCOT PANELS:

-Not available.

DOOR MATCH FILLERS/PILASTERS:

-Available.

-Minimum width: 3"W.

COMPLIMENTARY DOOR STYLES:

-MESA.

SPECIES AVAILABLE:

-MDF

DOOR PROFILE:

DOOR PROFILE

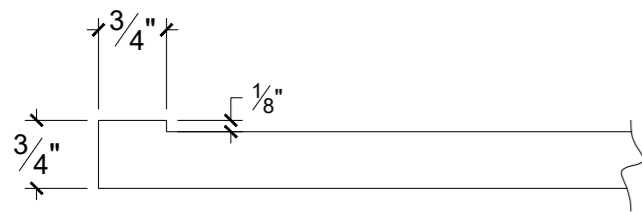

1LITE FRAME RAIL & MULLION PROFILE

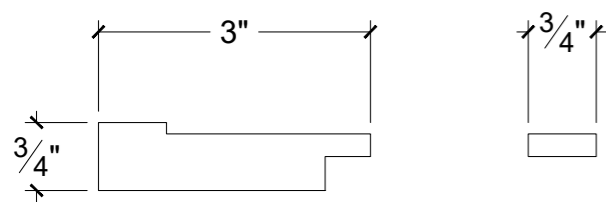

SMALL DRAWER FRONT OPTIONS (6"H):

SLAB

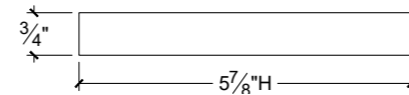
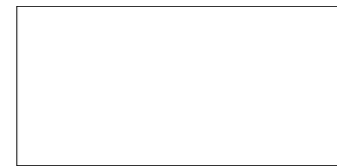

DOOR MATCH

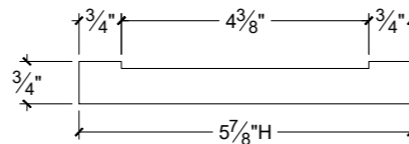
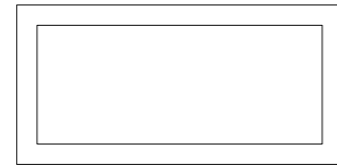

MINIMUM SIZE:

-3"W x 3"H.

-Smaller sizes will be Slab.

LARGE DRAWER FRONT OPTIONS:

SLAB

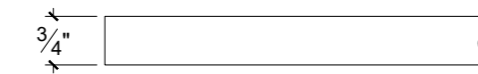
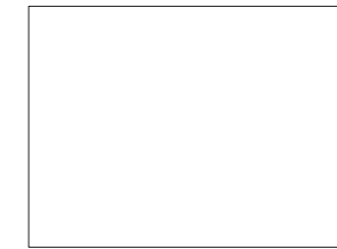

DOOR MATCH

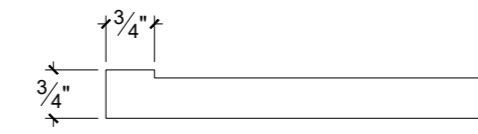
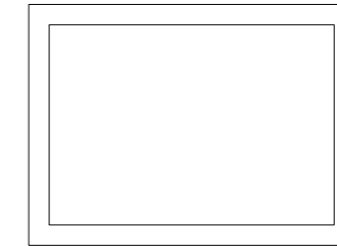

LOFTWOOD MDF DOOR



MDF
MULBERRY

DOOR STYLE SPECIFICATIONS:

DOOR CONSTRUCTION:

-1 Piece MDF.

MINIMUM SIZE:

-3"W x 3"H.

-Smaller sizes will be manufactured as Slab only.

-Subject to cabinet minimums.

MAXIMUM SIZE:

-24"W x 72"H.

-Larger doors are available but will void warranty.

GLASS DOORS:

-1LITE Frame Rail & Mullions available.

WAINSCOT PANELS:

-Not available.

DOOR MATCH FILLERS/PILASTERS:

-Available.

-Minimum width: 3"W.

COMPLIMENTARY DOOR STYLES:

-LOFT WOOD (Wood Door)

-WYNWOOD

SPECIES AVAILABLE:

-MDF

DOOR PROFILE:

DOOR PROFILE

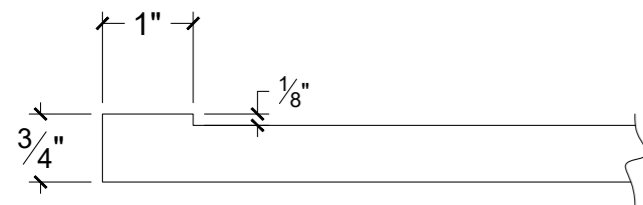

1LITE FRAME RAIL & MULLION PROFILE

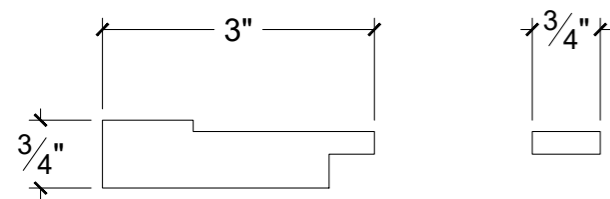

SMALL DRAWER FRONT OPTIONS (6"H):

SLAB

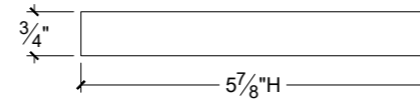
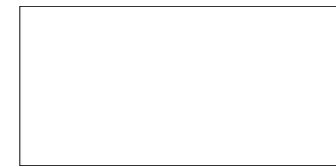

DOOR MATCH

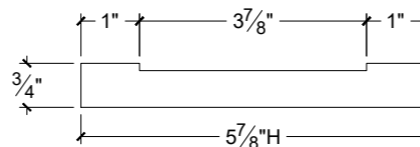
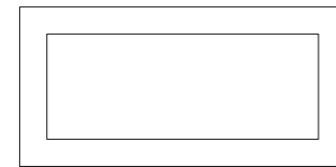

MINIMUM SIZE:

-3"W x 3"H.

-Smaller sizes will be Slab.

LARGE DRAWER FRONT OPTIONS:

SLAB



DOOR MATCH

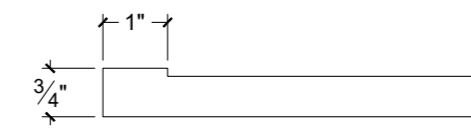
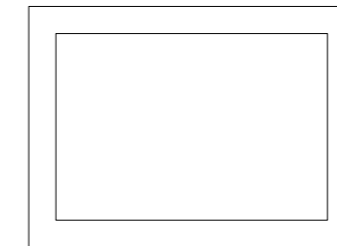

MANHATTAN MDF DOOR



MDF
OXFORD WHITE

DOOR STYLE SPECIFICATIONS:

DOOR CONSTRUCTION:

-1 Piece MDF.

MINIMUM SIZE:

-8"W x 8"H.

-Smaller sizes will be manufactured with reduced Rails.

-Subject to cabinet minimums.

MAXIMUM SIZE:

-24"W x 48"H.

-Larger doors will have cross rails. Cross Rails can be removed at no charge.

GLASS DOORS:

-1LITE Frame only.

-Mullions not available.

WAINSCOT PANELS:

-Available.

DOOR MATCH FILLERS/PILASTERS:

-Available.

-Minimum width: 3 1/2"W.

COMPLIMENTARY DOOR STYLES:

-MILAN (Wood Door)

SPECIES AVAILABLE:

-MDF

DOOR PROFILE:

DOOR PROFILE

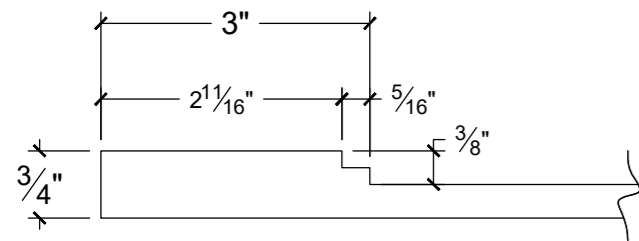

CROSS RAIL PROFILE

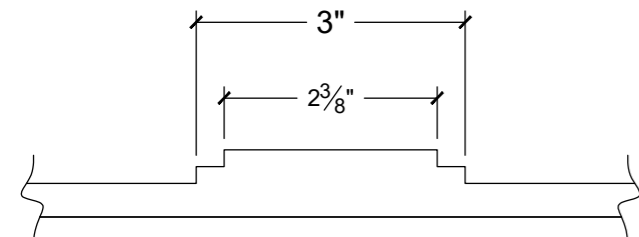

1LITE FRAME RAIL PROFILE

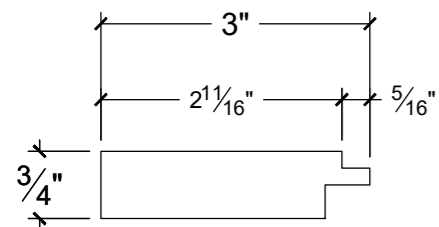

SMALL DRAWER FRONT OPTIONS (6"H):

SLAB

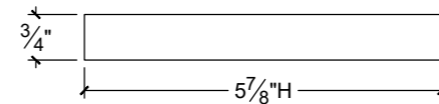
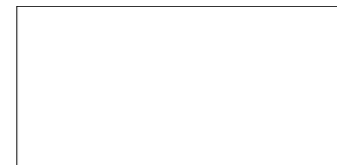

DOOR MATCH

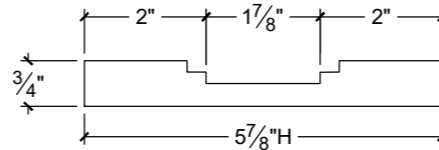
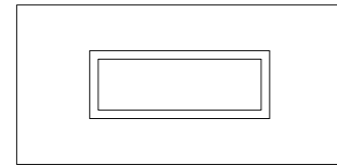

RAIL WIDTHS:

-Vertical rails will match door rails.

-Top & bottom rails are reduced.

MINIMUM SIZE:

-8"W x 5 7/8"H.

-Smaller sizes will be Slab.

LARGE DRAWER FRONT OPTIONS:

SLAB

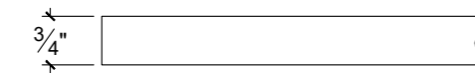

DOOR MATCH

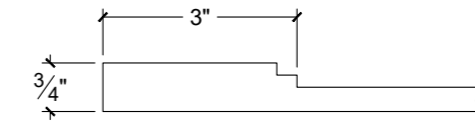
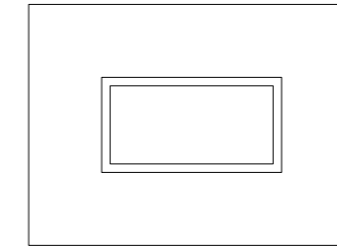

MESA MDF DOOR



MDF
WANDERLUST

DOOR STYLE SPECIFICATIONS:

DOOR CONSTRUCTION:

-1 Piece MDF.

MINIMUM SIZE:

-8"W x 8"H.

-Smaller sizes will be manufactured with 3/4" (Recessed) Profile only.

-Subject to cabinet minimums.

MAXIMUM SIZE:

-24"W x 72"H.

-Larger doors are available but will void warranty.

GLASS DOORS:

-1LITE Frame Rail & Mullions available.

WAINSCOT PANELS:

-Not available.

DOOR MATCH FILLERS/PILASTERS:

-Not available.

-Suggested alternative: LOFT.

COMPLIMENTARY DOOR STYLES:

-LOFT.

SPECIES AVAILABLE:

-MDF

DOOR PROFILE:

DOOR PROFILE

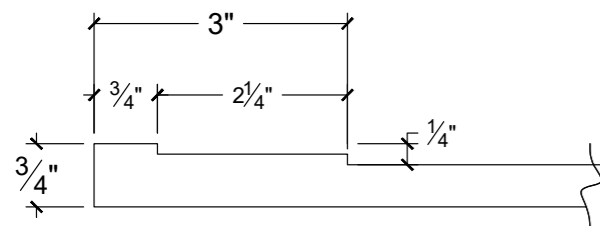

1LITE FRAME RAIL & MULLION PROFILE

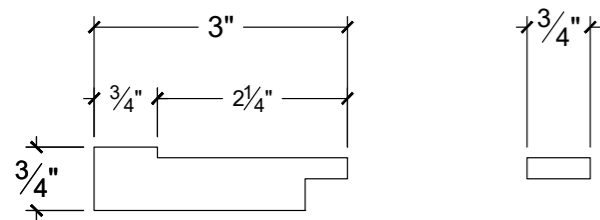

SMALL DRAWER FRONT OPTIONS (6"H):

SLAB

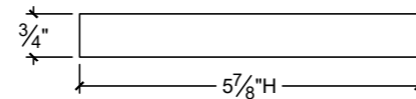
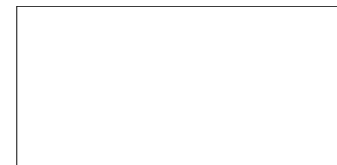

RECESSED

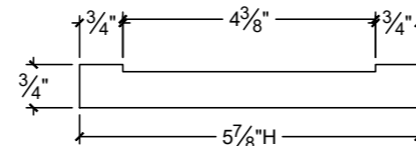
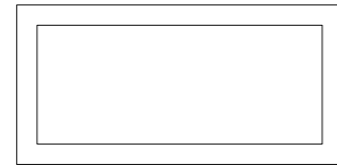

DOOR MATCH

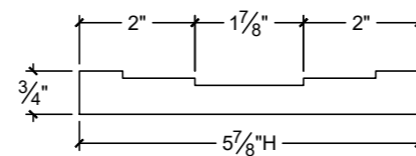
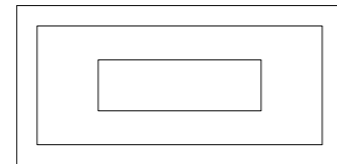

RAIL WIDTHS:

-Vertical rails will match door rails.

-Top & bottom rails are reduced.

MINIMUM SIZE:

-8"W x 5 7/8"H. Smaller sizes will be manufactured with 3/4" (Recessed) Profile only.

LARGE DRAWER FRONT OPTIONS:

SLAB

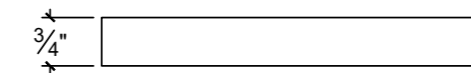
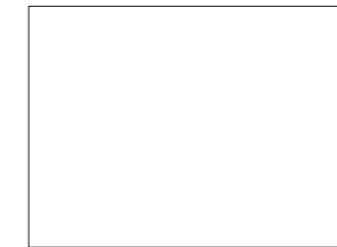

RECESSED

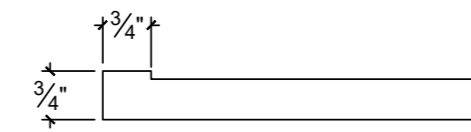
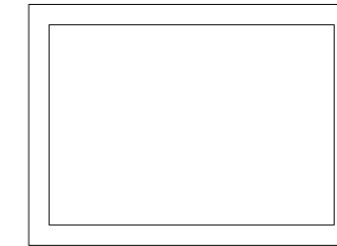

DOOR MATCH

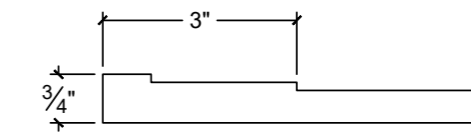
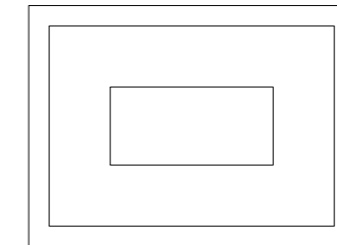

METRO MDF DOOR



MDF
NIMBUS

DOOR STYLE SPECIFICATIONS:

DOOR CONSTRUCTION:

-1 Piece MDF.

MINIMUM SIZE:

-8"W x 8"H.

-Smaller sizes will be manufactured with reduced Rails.

-Subject to cabinet minimums.

MAXIMUM SIZE:

-24"W x 48"H.

-Larger doors will have cross rails. Cross Rails can be removed at no charge.

GLASS DOORS:

-1LITE Frame Rail & Mullions available.

WAINSCOT PANELS:

-Available.

DOOR MATCH FILLERS/PILASTERS:

-Available.

-Minimum width: 3 1/2"W.

SPECIES AVAILABLE:

-MDF

DOOR PROFILE:

DOOR PROFILE

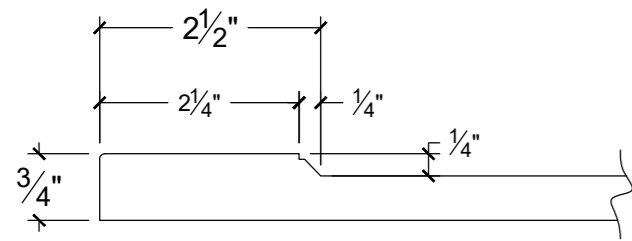

CROSS RAIL PROFILE

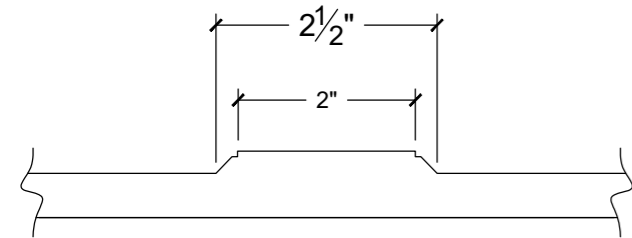

1LITE FRAME RAIL & MULLION PROFILE

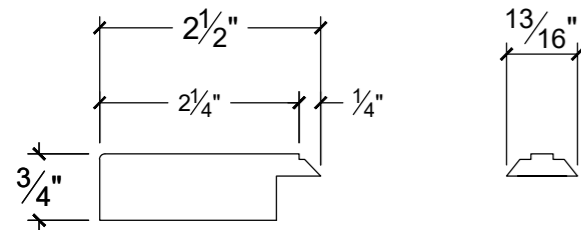

SMALL DRAWER FRONT OPTIONS (6"H):

SLAB

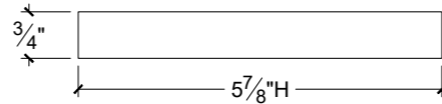
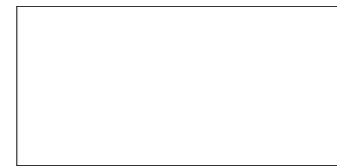

DOOR MATCH

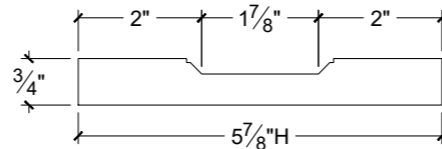
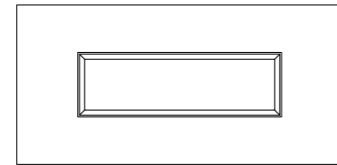

MINIMUM SIZE:

-8"W x 5 7/8"H.

-Smaller sizes will be Slab.

LARGE DRAWER FRONT OPTIONS:

SLAB

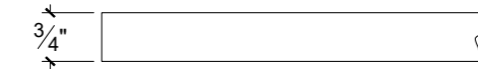
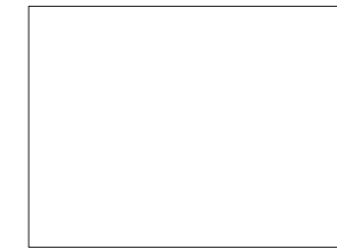

DOOR MATCH

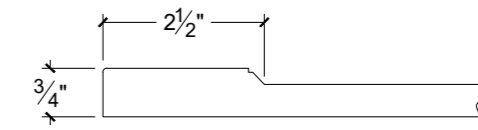
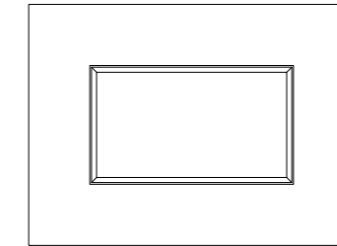

MIDTOWN MDF DOOR



MDF
HARBOURFRONT

DOOR STYLE SPECIFICATIONS:

DOOR CONSTRUCTION:

-1 Piece MDF.

MINIMUM SIZE:

-9"W x 9"H.

-Smaller sizes will be manufactured with reduced Rails.

-Subject to cabinet minimums.

MAXIMUM SIZE:

-24"W x 48"H.

-Larger doors will have cross rails. Cross Rails can be removed at no charge.

GLASS DOORS:

-1LITE Frame only.

-Mullions not available.

WAINSCOT PANELS:

-Available.

DOOR MATCH FILLERS/PILASTERS:

-Not available.

SPECIES AVAILABLE:

-MDF

DOOR PROFILE:

DOOR PROFILE

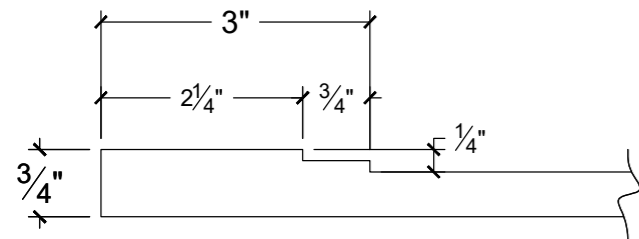

CROSS RAIL PROFILE

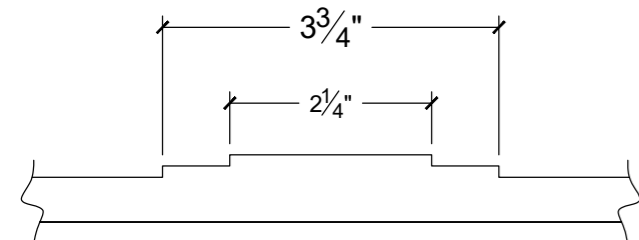

1LITE FRAME RAIL & MULLION PROFILE

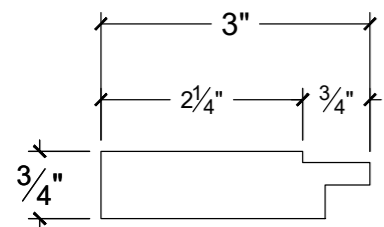

SMALL DRAWER FRONT OPTIONS (6"H):

SLAB

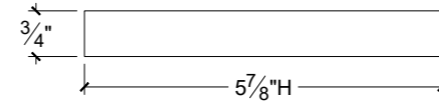
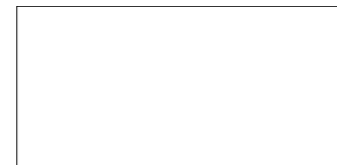

DOOR MATCH

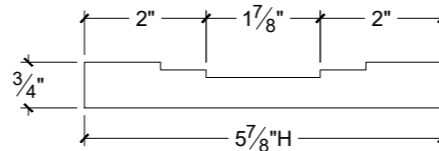
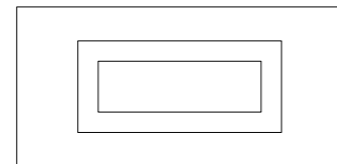

MINIMUM SIZE:

-9"W x 5 7/8"H.

-Smaller sizes will be Slab.

LARGE DRAWER FRONT OPTIONS:

SLAB



DOOR MATCH

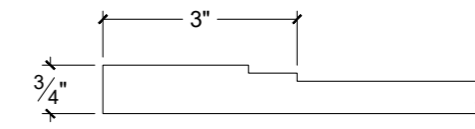
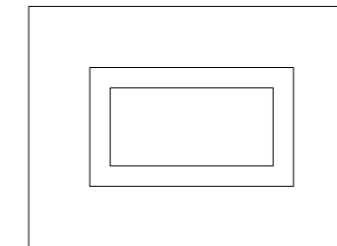

MODEST MDF DOOR



MDF
ONYX

DOOR STYLE SPECIFICATIONS:

DOOR CONSTRUCTION:

-1 Piece MDF.

MINIMUM SIZE:

-3"W x 3"H.

-Subject to cabinet minimums.

MAXIMUM SIZE:

-24"W x 72"H.

-Larger doors are available but will void warranty.

GLASS DOORS:

-1LITE Frame Rail & Mullions available.

WAINSCOT PANELS:

-Not available.

DOOR MATCH FILLERS/PILASTERS:

-Not available.

SPECIES AVAILABLE:

-MDF

DOOR PROFILE:

DOOR PROFILE



1LITE FRAME RAIL & MULLION PROFILE

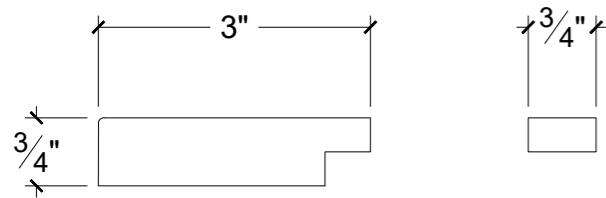

SMALL DRAWER FRONT OPTIONS (6"H):

SLAB

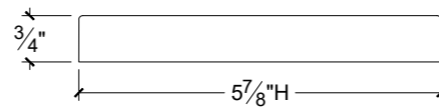
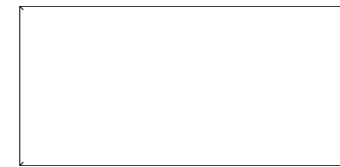

LARGE DRAWER FRONT OPTIONS:

SLAB

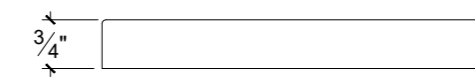
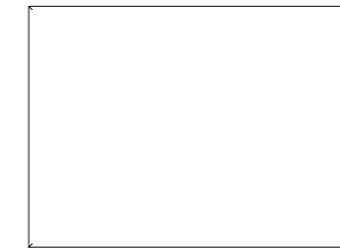

NEWPORT MDF DOOR



MDF
HINT OF MINT

DOOR STYLE SPECIFICATIONS:

DOOR CONSTRUCTION:

-1 Piece MDF.

MINIMUM SIZE:

-7"W x 7"H.

-Smaller sizes will be manufactured with reduced Rails.

-Subject to cabinet minimums.

MAXIMUM SIZE:

-24"W x 48"H.

-Larger doors will have cross rails. Cross Rails can be removed at no charge.

GLASS DOORS:

-1LITE Frames only.

-Mullions not available.

WAINSCOT PANELS:

-Not available.

DOOR MATCH FILLERS/PILASTERS:

-Not available.

-Suggested alternative: EMPIRE.

COMPLIMENTARY DOOR STYLES:

-EMPIRE

SPECIES AVAILABLE:

-MDF

DOOR PROFILE:

DOOR PROFILE

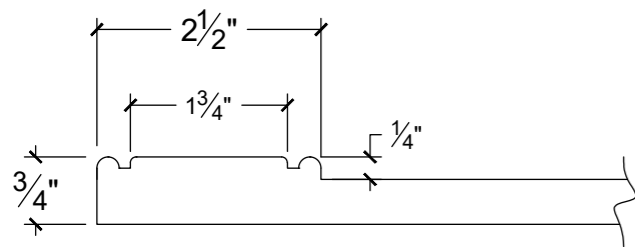

CROSS RAIL PROFILE

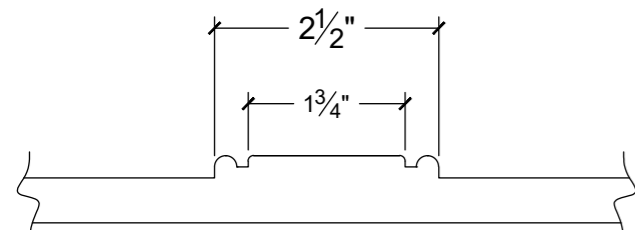

1LITE FRAME RAIL & MULLION PROFILE

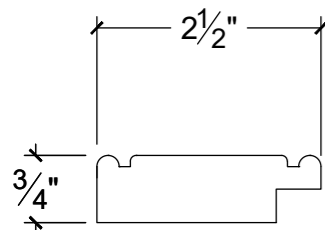

SMALL DRAWER FRONT OPTIONS (6"H):

SLAB

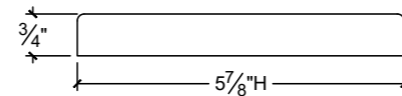
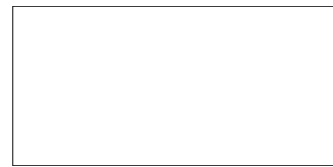

RECESSED

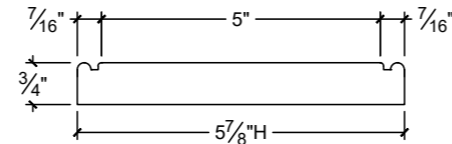
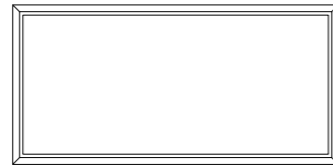

DOOR MATCH

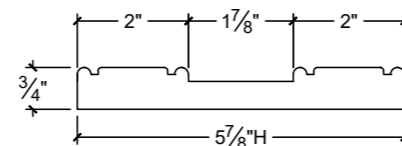
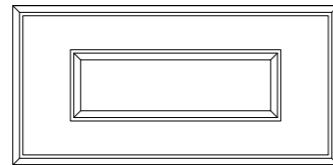

RAIL WIDTHS:

-Vertical rails will match door rails.

-Top & bottom rails are reduced.

MINIMUM SIZE:

-7"W x 5 7/8"H. Smaller sizes will be manufactured with outside Bead (Recessed) Profile only.

LARGE DRAWER FRONT OPTIONS:

SLAB

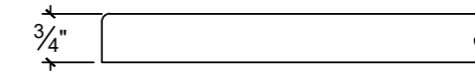
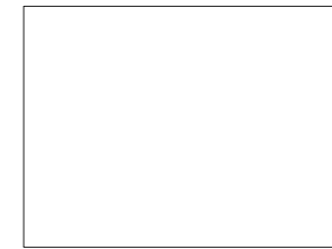

RECESSED

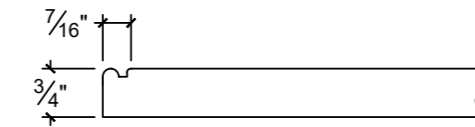
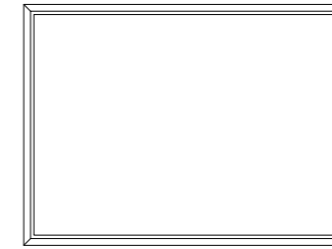

DOOR MATCH

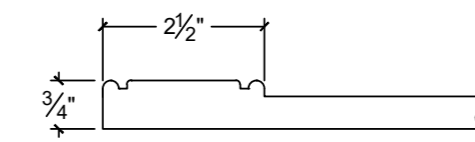
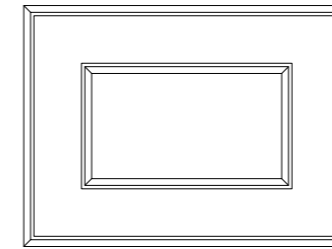

NORTHSHORE MDF DOOR



MDF
CHANTILLY LACE

DOOR STYLE SPECIFICATIONS:

DOOR CONSTRUCTION:

-1 Piece MDF.

MINIMUM SIZE:

-6 1/2"W x 6 1/2"H.

-Smaller sizes will be manufactured with reduced Rails.

-Subject to cabinet minimums.

MAXIMUM SIZE:

-24"W x 48"H.

-Larger doors will have cross rails. Cross Rails can be removed at no charge.

GLASS DOORS:

-1LITE Frame Rail & Mullions available.

WAINSCOT PANELS:

-Available.

DOOR MATCH FILLERS/PILASTERS:

-Available.

-Minimum width: 3 1/2"W.

COMPLIMENTARY DOOR STYLES:

-WALES.

SPECIES AVAILABLE:

-MDF

DOOR PROFILE:

DOOR PROFILE

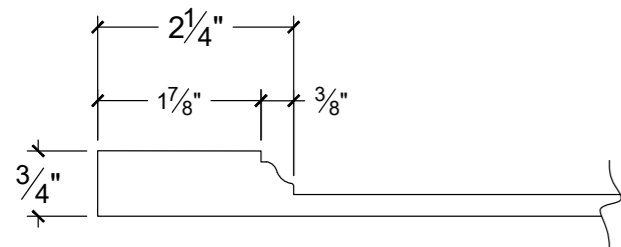

CROSS RAIL PROFILE

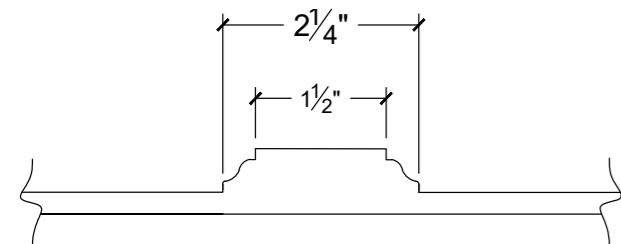

1LITE FRAME RAIL & MULLION PROFILE

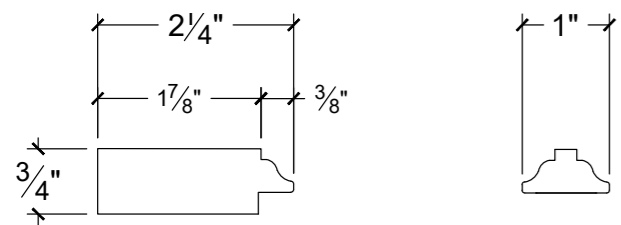

SMALL DRAWER FRONT OPTIONS (6"H):

SLAB

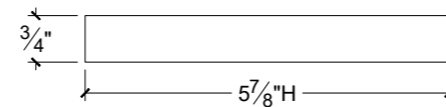

DOOR MATCH

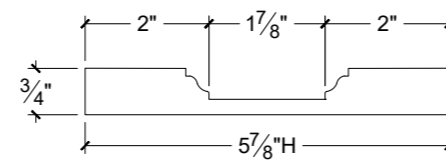
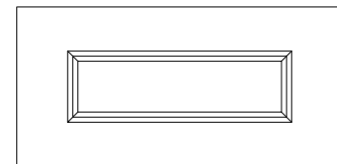

MINIMUM SIZE:

-6 1/2"W x 5 7/8"H.

-Smaller sizes will be Slab.

LARGE DRAWER FRONT OPTIONS:

SLAB

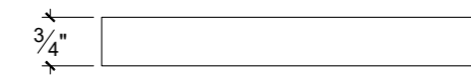
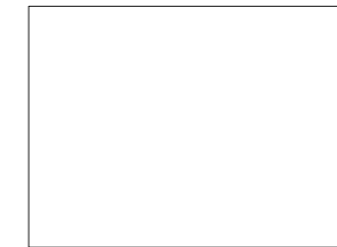

DOOR MATCH

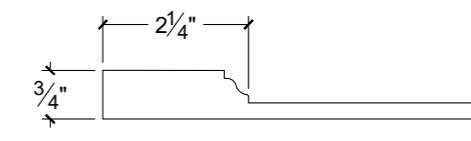
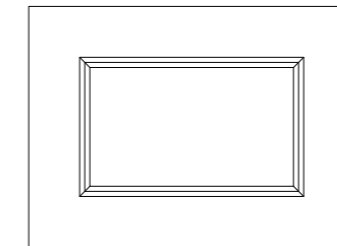

NOTTINGHAM MDF DOOR



MDF
NOTTINGHAM

DOOR STYLE SPECIFICATIONS:

DOOR CONSTRUCTION:

-1 Piece MDF.

MINIMUM SIZE:

-8"W x 8"H.

-Smaller sizes will be manufactured with reduced Rails.

-Subject to cabinet minimums.

MAXIMUM SIZE:

-24"W x 48"H.

-Larger doors will have cross rails. Cross Rails can be removed at no charge.

GLASS DOORS:

-1LITE Frame Rail & Mullions available.

WAINSCOT PANELS:

-Available.

-Edge profile will be defaulted to square.

DOOR MATCH FILLERS/PILASTERS:

-Available.

-Minimum width: 3 1/2"W.

-Centre panel will be recessed.

-Edge profile will be defaulted to square.

SPECIES AVAILABLE:

-MDF

DOOR PROFILE:

DOOR PROFILE

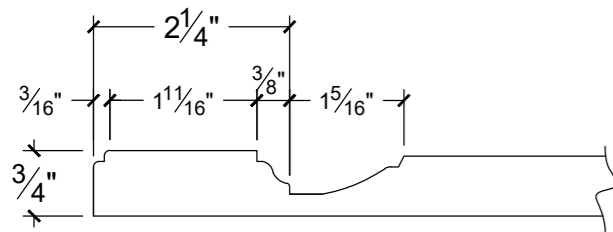

CROSS RAIL PROFILE

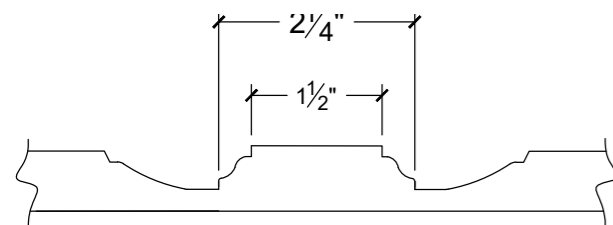

1LITE FRAME RAIL & MULLION PROFILES

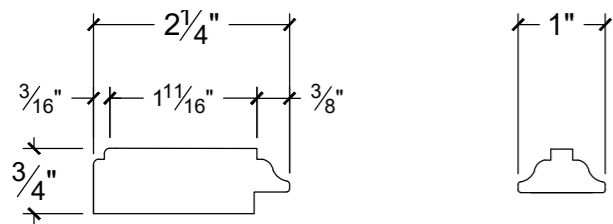

SMALL DRAWER FRONT OPTIONS (6"H):

SLAB

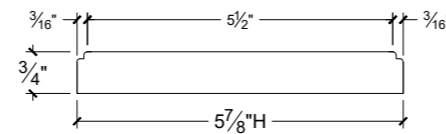

RECESSED

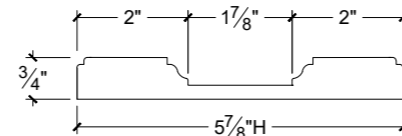
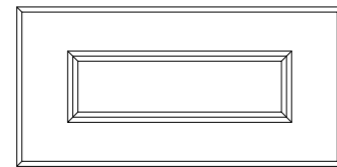

RAIL WIDTHS:

-Vertical rails will match door rails.

-Top & bottom rails are reduced.

MINIMUM SIZE:

-8"W x 5 7/8"H.

-Smaller sizes will be manufactured as Slab.

LARGE DRAWER FRONT OPTIONS:

SLAB

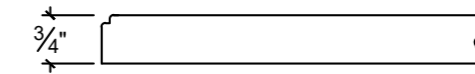
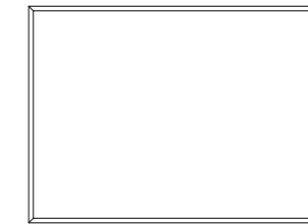

RECESSED

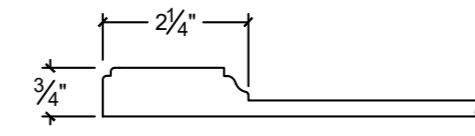
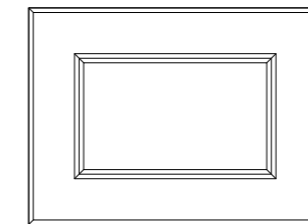

DOOR MATCH

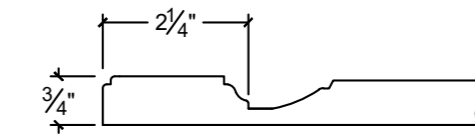
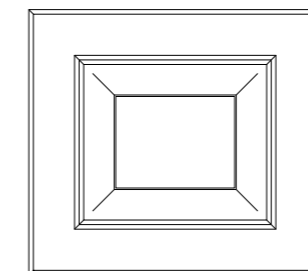

MINIMUM SIZE:

-8"W x 8"H

-Smaller sizes will be Recessed.

PORTLAND MDF DOOR



MDF
SILVER CHAIN

DOOR STYLE SPECIFICATIONS:

DOOR CONSTRUCTION:

-1 Piece MDF.

MINIMUM SIZE:

-8 1/2"W x 8 1/2"H.

-Smaller sizes will be manufactured with reduced Rails.

-Subject to cabinet minimums.

MAXIMUM SIZE:

-24"W x 48"H.

-Larger doors will have cross rails. Cross Rails can be removed at no charge.

GLASS DOORS:

-1LITE Frame Rail & Mullions available.

WAINSCOT PANELS:

-Available.

-Edge profile will be defaulted to square.

DOOR MATCH FILLERS/PILASTERS:

-Available.

-Minimum width: 3 1/2"W.

-Centre panel will be recessed.

-Edge profile will be defaulted to square.

SPECIES AVAILABLE:

-MDF

DOOR PROFILE:

DOOR PROFILE

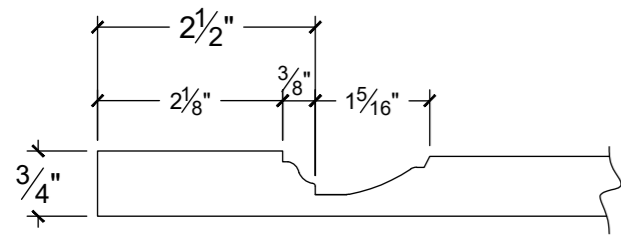

CROSS RAIL PROFILE

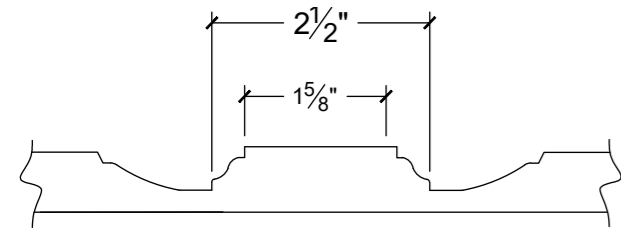

1LITE FRAME RAIL & MULLION PROFILE

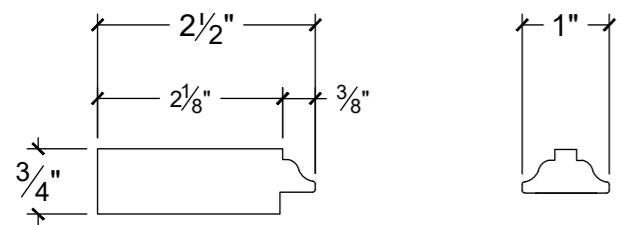

SMALL DRAWER FRONT OPTIONS (6"H):

SLAB

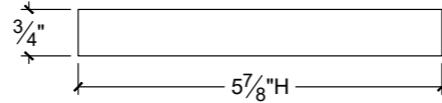
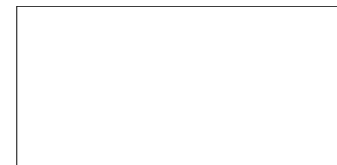

RECESSED

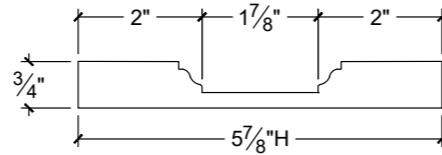
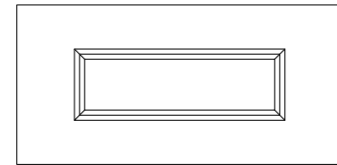

RAIL WIDTHS:

-Vertical rails will match door rails.

-Top & bottom rails are reduced.

MINIMUM SIZE:

-8 1/2"W x 5 7/8"H.

-Smaller sizes will be manufactured as Slab.

LARGE DRAWER FRONT OPTIONS:

SLAB

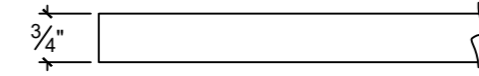
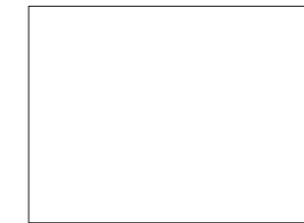

RECESSED

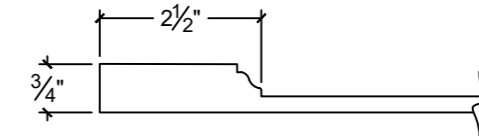
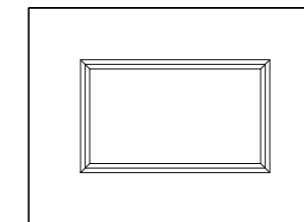

DOOR MATCH

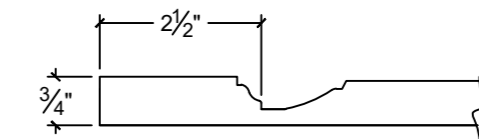
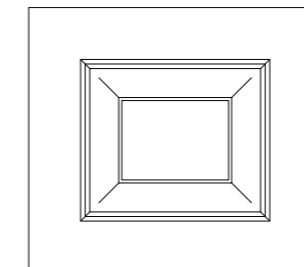

MINIMUM SIZE:

-8 1/2"W x 8 1/2"H

-Smaller sizes will be Recessed.

SOHO MDF DOOR



MDF
JAIPUR

DOOR STYLE SPECIFICATIONS:

DOOR CONSTRUCTION:

-1 Piece MDF.

MINIMUM SIZE:

-7"W x 7"H.

-Smaller sizes will be manufactured with reduced Rails.

-Subject to cabinet minimums.

MAXIMUM SIZE:

-24"W x 48"H.

-Larger doors will have cross rails. Cross Rails can be removed at no charge.

GLASS DOORS:

-1LITE Frames only.

-Mullions not available.

WAINSCOT PANELS:

- Available.

DOOR MATCH FILLERS/PILASTERS:

- Available.

- Minimum width: 3 1/2"W.

COMPLIMENTARY DOOR STYLES:

-ESQUIRE (Wood Door)

SPECIES AVAILABLE:

-MDF

DOOR PROFILE:

DOOR PROFILE

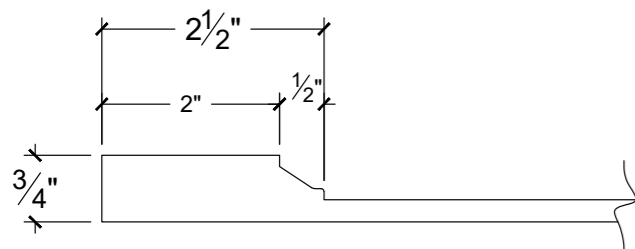

CROSS RAIL PROFILE

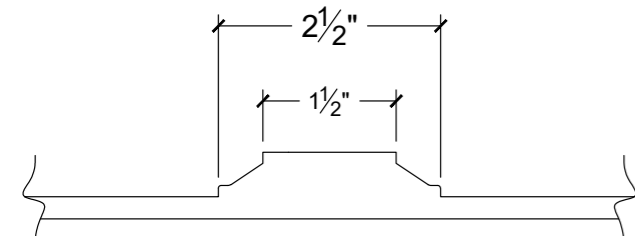

1LITE FRAME RAIL PROFILE

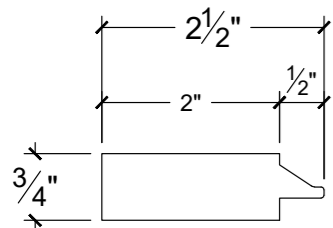

SMALL DRAWER FRONT OPTIONS (6"H):

SLAB

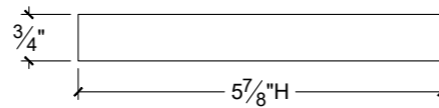
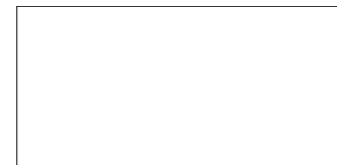

DOOR MATCH

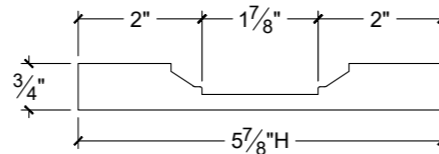
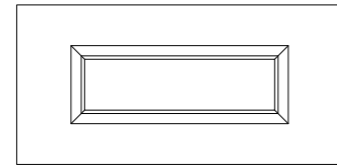

RAIL WIDTHS:

- Vertical rails will match door rails.

- Top & bottom rails are reduced.

MINIMUM SIZE:

-7 "W x 5 7/8"H.

-Smaller sizes will be Slab.

LARGE DRAWER FRONT OPTIONS:

SLAB

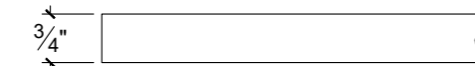

DOOR MATCH

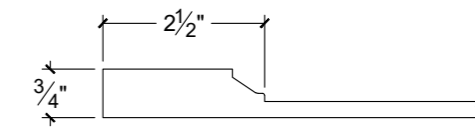
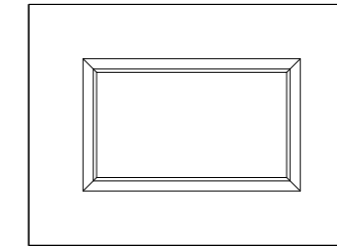

TARSIA MDF DOOR



MDF
MARIGOLD

DOOR STYLE SPECIFICATIONS:

DOOR CONSTRUCTION:

-1 Piece MDF.

MINIMUM SIZE:

-6 1/2"W x 6 1/2"H.

-Smaller sizes will be manufactured with reduced Rails.

-Subject to cabinet minimums.

MAXIMUM SIZE:

-24"W x 48"H.

-Larger doors will have cross rails. Cross Rails can be removed at no charge.

GLASS DOORS:

-1LITE Frame Rail & Mullions available.

WAINSCOT PANELS:

-Available.

DOOR MATCH FILLERS/PILASTERS:

-Available.

-Minimum width: 3"W.

SPECIES AVAILABLE:

-MDF

DOOR PROFILE:

DOOR PROFILE

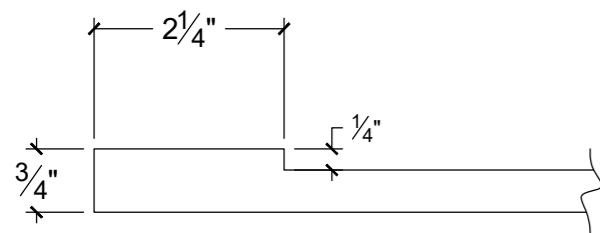

CROSS RAIL PROFILE

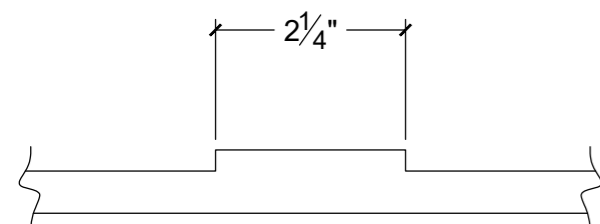

1LITE FRAME RAIL & MULLION PROFILES

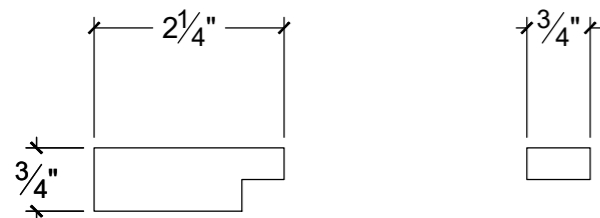

SMALL DRAWER FRONT OPTIONS (6"H):

SLAB

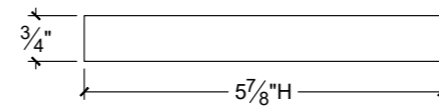
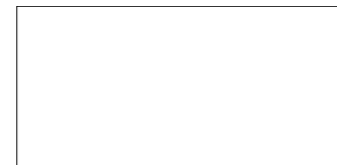

DOOR MATCH

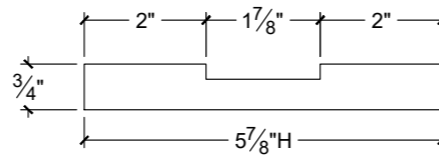
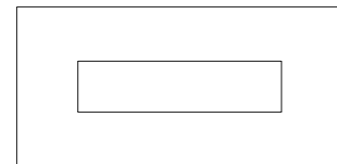

MINIMUM SIZE:

-6 1/2"W x 5 7/8"H.

-Smaller sizes will be Slab.

LARGE DRAWER FRONT OPTIONS:

SLAB

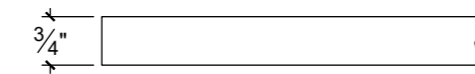

DOOR MATCH

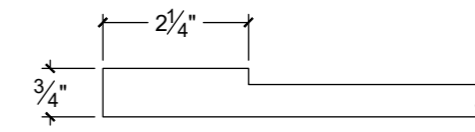
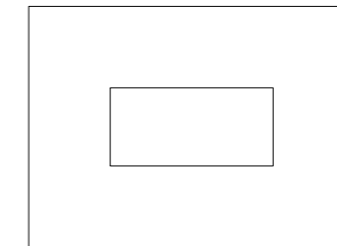

TIRANA MDF DOOR



MDF
SAGEBRUSH

DOOR STYLE SPECIFICATIONS:

DOOR CONSTRUCTION:

-1 Piece MDF.

MINIMUM SIZE:

-6"W x 6"H.

-Smaller sizes will be manufactured as Slab only.

-Subject to cabinet minimums.

MAXIMUM SIZE:

-24"W x 72"H.

-Larger doors are available but will void warranty.

GLASS DOORS:

-1LITE Frames only.

-Mullions not available.

WAINSCOT PANELS:

-Not available.

DOOR MATCH FILLERS/PILASTERS:

-Available.

-Minimum width: 5"W.

SPECIES AVAILABLE:

-MDF

DOOR PROFILE:

DOOR PROFILE

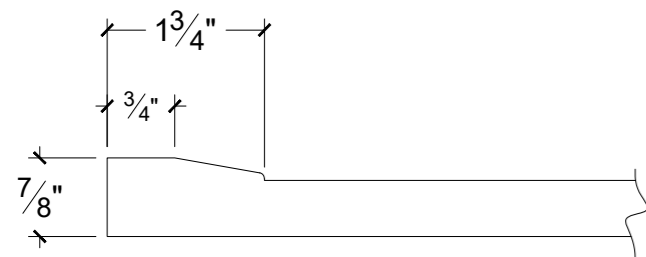

1LITE FRAME RAIL PROFILE

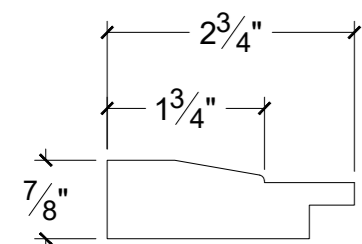

SMALL DRAWER FRONT OPTIONS (6"H):

SLAB

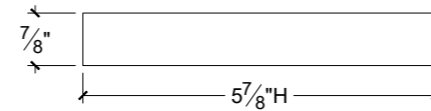
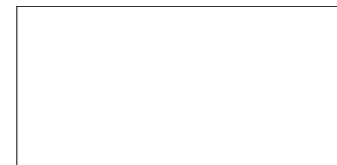

DOOR MATCH

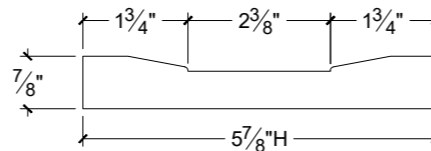
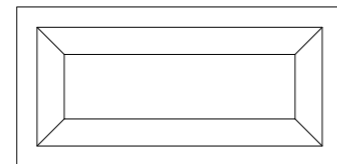

MINIMUM SIZE:

-6"W x 5 7/8"H.

-Smaller sizes will be Slab.

LARGE DRAWER FRONT OPTIONS:

SLAB

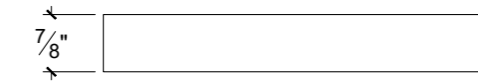
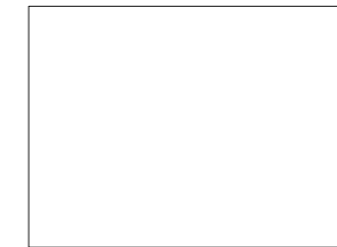

DOOR MATCH

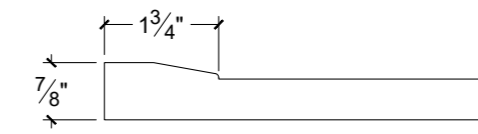
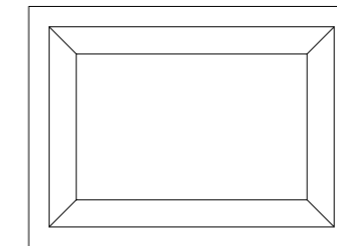

TORONTO MDF DOOR



MDF
APRIL SHOWERS

DOOR STYLE SPECIFICATIONS:

DOOR CONSTRUCTION:

-1 Piece MDF.

MINIMUM SIZE:

-8"W x 8"H.

-Smaller sizes will be manufactured with reduced Rails.

-Subject to cabinet minimums.

MAXIMUM SIZE:

-24"W x 48"H.

-Larger doors will have cross rails. Cross Rails can be removed at no charge.

GLASS DOORS:

-1LITE Frame Rail & Mullions available.

WAINSCOT PANELS:

-Available.

DOOR MATCH FILLERS/PILASTERS:

-Available.

-Minimum width: 3"W.

SPECIES AVAILABLE:

-MDF

DOOR PROFILE:

DOOR PROFILE

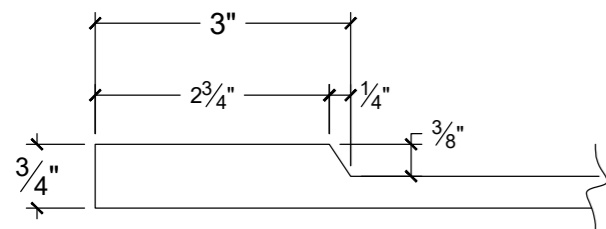

CROSS RAIL PROFILE

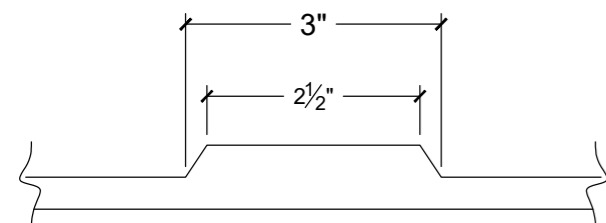

1LITE FRAME RAIL & MULLION PROFILES

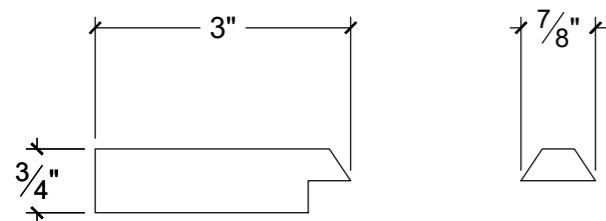

SMALL DRAWER FRONT OPTIONS (6"H):

SLAB

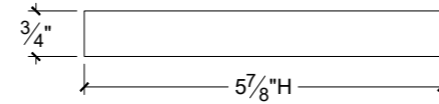
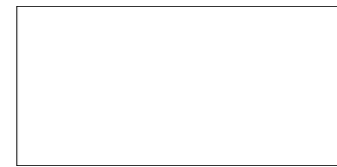

DOOR MATCH

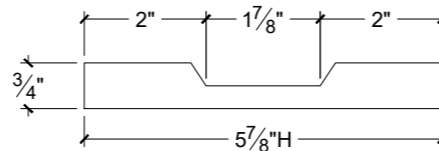
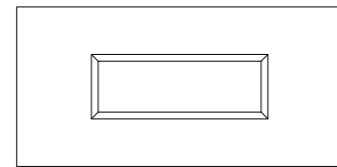

MINIMUM SIZE:

-8"W x 5 7/8"H.

-Smaller sizes will be Slab.

LARGE DRAWER FRONT OPTIONS:

SLAB

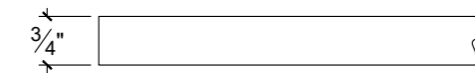
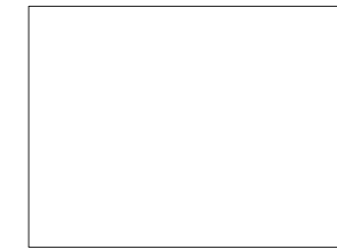

DOOR MATCH

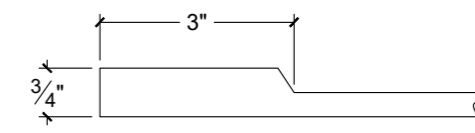
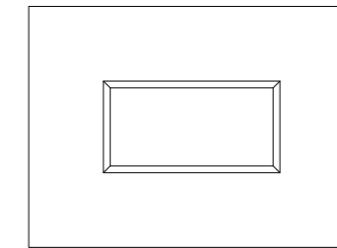

WALES MDF DOOR



MDF
LAKESHORE BLUE

DOOR STYLE SPECIFICATIONS:

DOOR CONSTRUCTION:

-1 Piece MDF.

MINIMUM SIZE:

-8"W x 8"H.

-Smaller sizes will be manufactured with reduced Rails.

-Subject to cabinet minimums.

MAXIMUM SIZE:

-24"W x 48"H.

-Larger doors will have cross rails. Cross Rails can be removed at no charge.

GLASS DOORS:

-1LITE Frame Rail & Mullions available.

WAINSCOT PANELS:

-Available.

-Edge profile will be defaulted to square.

DOOR MATCH FILLERS/PILASTERS:

-Available.

-Minimum width: 3 1/2"W.

-Centre panel will be recessed.

-Edge profile will be defaulted to square.

COMPLIMENTARY DOOR STYLES:

-NORTHSHORE.

SPECIES AVAILABLE:

-MDF

DOOR PROFILE:

DOOR PROFILE

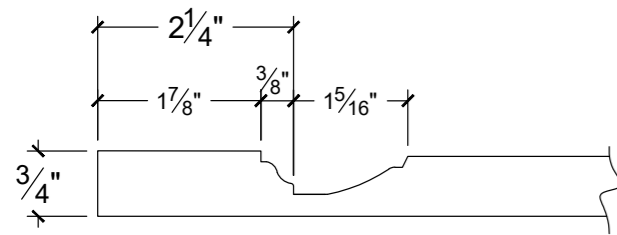

CROSS RAIL PROFILE

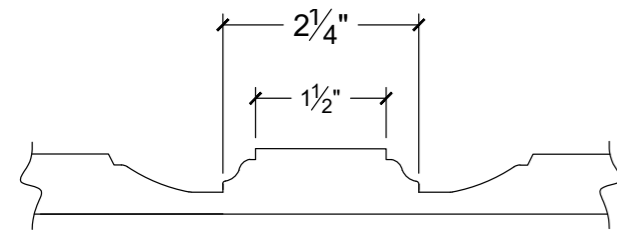

1LITE FRAME RAIL & MULLION PROFILE

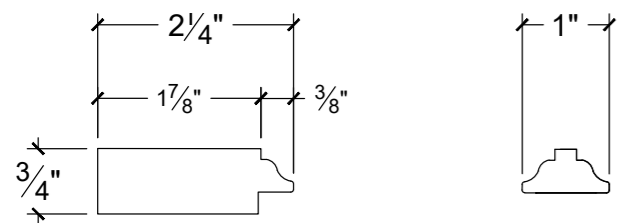

SMALL DRAWER FRONT OPTIONS (6"H):

SLAB

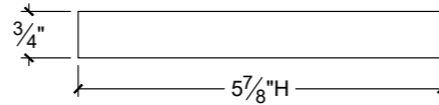
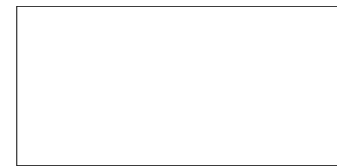

RECESSED

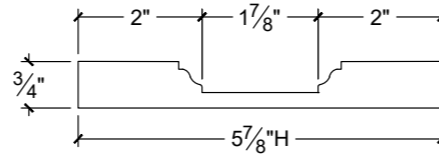
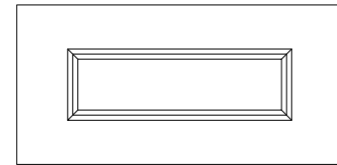

RAIL WIDTHS:

-Vertical rails will match door rails.

-Top & bottom rails are reduced.

MINIMUM SIZE:

-8"W x 5 7/8"H.

-Smaller sizes will be manufactured as Slab.

LARGE DRAWER FRONT OPTIONS:

SLAB

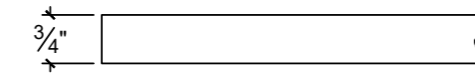
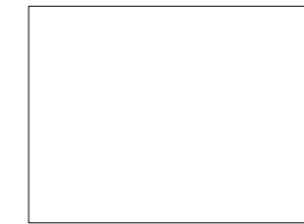

RECESSED

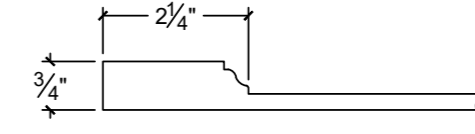
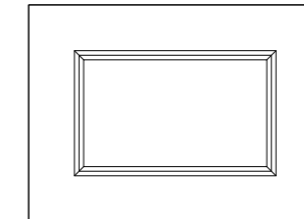

DOOR MATCH

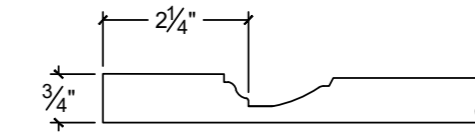
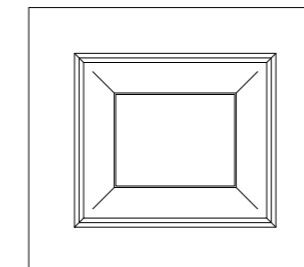

MINIMUM SIZE:

-8"W x 8"H

-Smaller sizes will be Recessed.

WYNWOOD MDF DOOR



MDF
BLISS

DOOR STYLE SPECIFICATIONS:

DOOR CONSTRUCTION:

-1 Piece MDF.

MINIMUM SIZE:

-10"W x 10"H.

-Smaller sizes will be manufactured with 1" (Recessed) Profile only.

-Subject to cabinet minimums.

MAXIMUM SIZE:

-24"W x 72"H.

-Larger doors are available but will void warranty.

GLASS DOORS:

-1LITE Frame Rail & Mullions available.

WAINSCOT PANELS:

-Not available.

DOOR MATCH FILLERS/PILASTERS:

-Available.

-Minimum width: 3"W.

-Will have outside 1" Profile only.

COMPLIMENTARY DOOR STYLES:

-LOFTWOOD MDF

-LOFT WOOD (Wood Door)

SPECIES AVAILABLE:

-MDF

DOOR PROFILE:

DOOR PROFILE

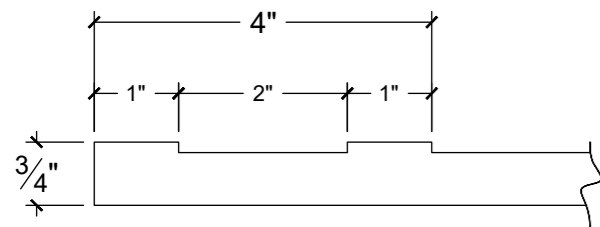

1LITE FRAME RAIL & MULLION PROFILE

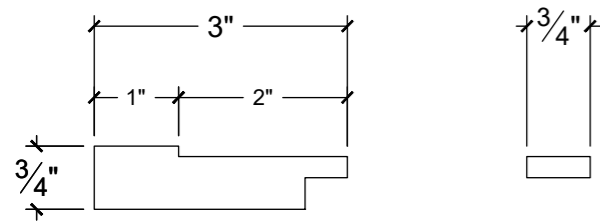

SMALL DRAWER FRONT OPTIONS (6"H):

SLAB

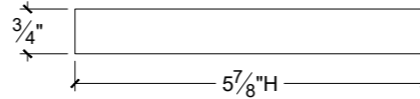
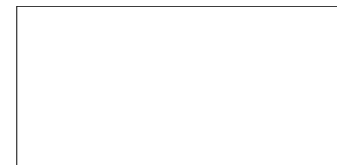

RECESSED

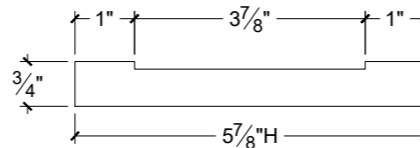
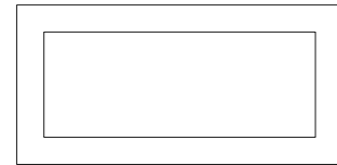

MINIMUM SIZE:

-6"W x 5 7/8"H.

-Smaller sizes will be manufactured as Slab.

LARGE DRAWER FRONT OPTIONS:

SLAB

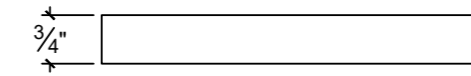
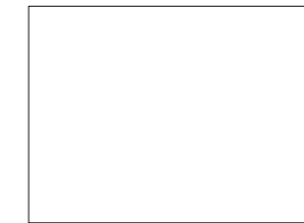

RECESSED

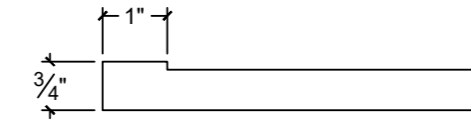
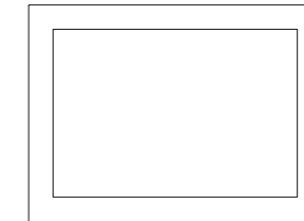

DOOR MATCH

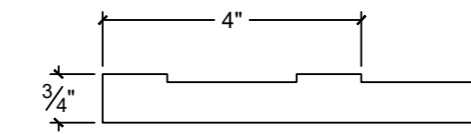
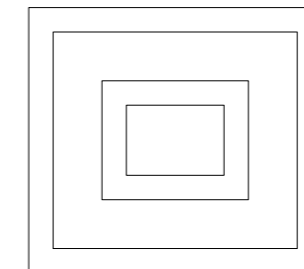

MINIMUM SIZE:

-10"W x 10"H

-Smaller sizes will be Recessed.

LAMINATE & P.E.T. DOORS

BISTRO LAMINATE DOOR:



LAMINATE
WHITEHAVEN

DOOR STYLE SPECIFICATIONS:

DOOR CONSTRUCTION:

- 5 Piece Laminate Door with Recessed Centre Panel.

MINIMUM SIZE:

- 6 1/2"W x 6 1/2"H.

- Smaller sizes will be manufactured with reduced rails or be Slab.

- Subject to cabinet minimums.

MAXIMUM SIZE:

- 24"W x 48"H.

- Larger doors will have cross rails. Cross Rails can be removed at no additional charge.

GLASS DOORS:

- 1LITE Frames only.

- Mullions not available.

WAINSCOT PANELS:

- Available.

DOOR MATCH FILLERS/PILASTERS:

- Available.

- Minimum width: 3"W.

FINISHES AVAILABLE:

- BONDÍ
- COPACABANA
- NAVAGIO
- TULUM
- VERADERO
- WHITEHAVEN

DOOR PROFILE:

DOOR PROFILE

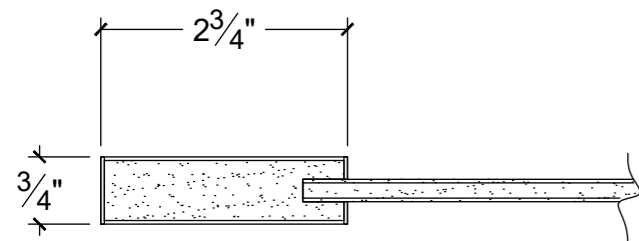

CROSS RAIL PROFILE

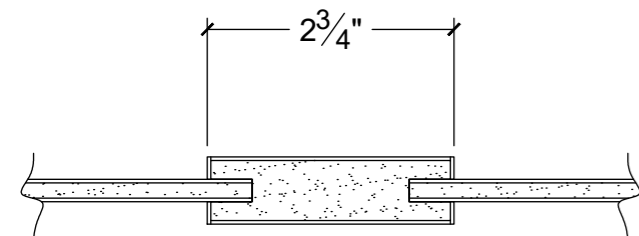

1LITE FRAME RAIL & MULLION PROFILES

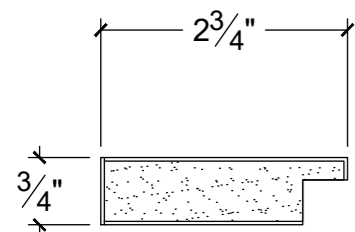

SMALL DRAWER FRONT OPTIONS (6"H):

SLAB

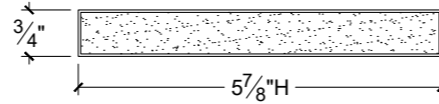
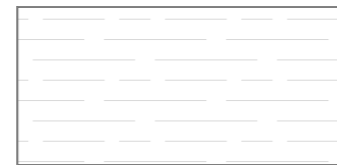

LARGE DRAWER FRONT OPTIONS:

SLAB

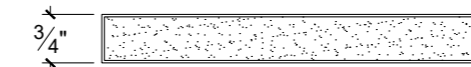
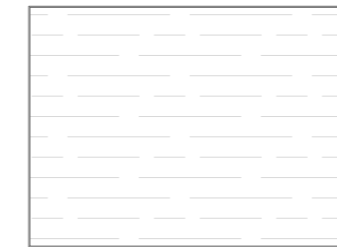

DOOR MATCH

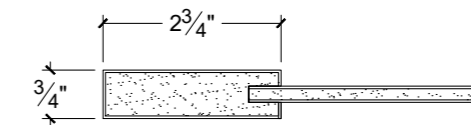
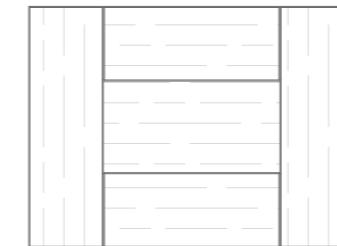

MODE LAMINATE & P.E.T. DOOR:



LAMINATE
YOSEMITE

DOOR STYLE SPECIFICATIONS:

DOOR CONSTRUCTION:

-Laminate Panel door with MDF or Particle core.

MINIMUM SIZE:

-3"W x 3"H.

-Subject to cabinet minimums.

MAXIMUM SIZE:

-24"W x 72"H.

-Larger doors are available but will void warranty.

GLASS DOORS:

-1LITE Frames only.

-Mullions not available.

WAINSCOT PANELS:

-Not available.

DOOR MATCH FILLERS/PILASTERS:

-Not available.

GRAIN DIRECTION:

-Vertical Grain by default.

-Horizontal Grain is available as an upgrade.

GRAIN-MATCHING:

-Grain-Matching is available as an upgrade.

-Grain-Matching applies to Cabinet Fronts only.

-Fillers, Panels, Pilasters, etc. will not be matched.

-Grain-Matching is limited to the size of a veneered panel (48"W x 96"H or 96"W x 48"H).

-Floor plans & Elevation drawings are required.

FINISHES AVAILABLE:

-All Laminates & P.E.T.s.

DOOR PROFILE:

DOOR PROFILE

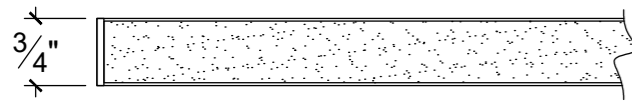

1LITE FRAME RAIL PROFILE

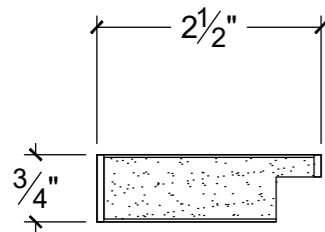

SMALL DRAWER FRONT OPTIONS (6"H):

DOOR MATCH

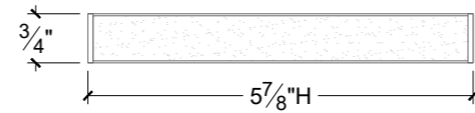

LARGE DRAWER FRONT OPTIONS:

DOOR MATCH

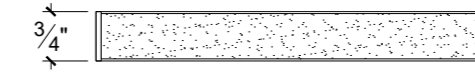

NOUVEAU LAMINATE & P.E.T. DOOR:



LAMINATE
AURORA

DOOR STYLE SPECIFICATIONS:

DOOR CONSTRUCTION:

- Laminate Panel door with MDF or Particle core with integral chrome finished handle.

MINIMUM SIZE:

- 9"W x 6"H.
- Subject to cabinet minimums.
- Smaller sizes will not have a handle.

MAXIMUM SIZE:

- 24"W x 72"H.
- Larger doors are available but will void warranty.

GLASS DOORS:

- 1LITE Frames only.
- Mullions not available.

WAINSCOT PANELS:

- Not available.

DOOR MATCH FILLERS/PILASTERS:

- Not available.

GRAIN DIRECTION:

- Vertical Grain by default.
- Horizontal Grain is available as an upgrade.

GRAIN-MATCHING:

- Grain-Matching is available as an upgrade.
- Grain-Matching applies to Cabinet Fronts only. Fillers, Panels, Pilasters, etc. will not be matched.
- Grain-Matching is limited to the size of a veneered panel (48"W x 96"H or 96"W x 48"H).
- Floor plans & Elevation drawings are required.

FINISHES AVAILABLE:

- All Laminates & P.E.T.s.

DOOR PROFILE:

DOOR PROFILE

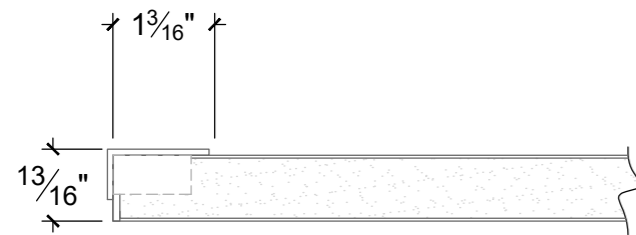

1LITE FRAME RAIL PROFILE

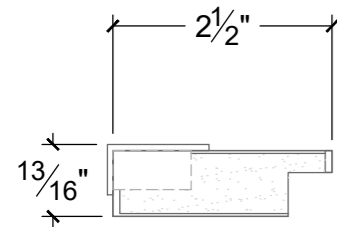

HANDLE FACE

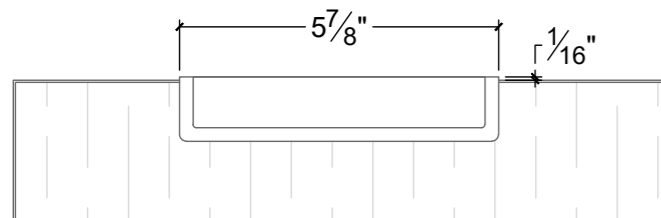

SMALL DRAWER FRONT OPTIONS (6"H):

DOOR MATCH

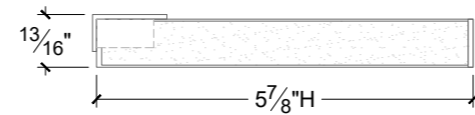
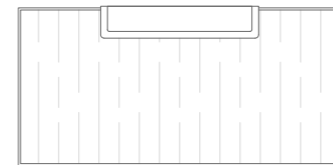

LARGE DRAWER FRONT OPTIONS:

DOOR MATCH

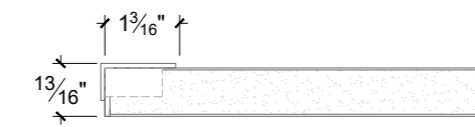
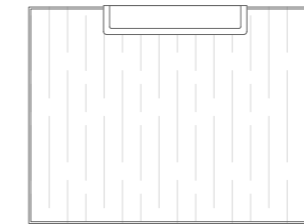

HANDLE LOCATIONS:

WALL CABINETS:

- Centered on bottom edge of doors.
- Centered on top edge of drawer fronts.

BASE CABINETS:

- Centered on top edge of doors & drawer fronts.

TALL CABINETS:

- Centered on bottom edge of top doors.
- Centered on top edge of lower doors & drawer fronts.

WIDE DRAWER FRONTS:

- Drawer fronts 30" (nominal) & wider will receive 2 handles.
- The handles will be centered on each half of the front &/or line up with double doors above.

MODIFICATIONS:

- The handle positions can be modified. A modification charge will be applied.

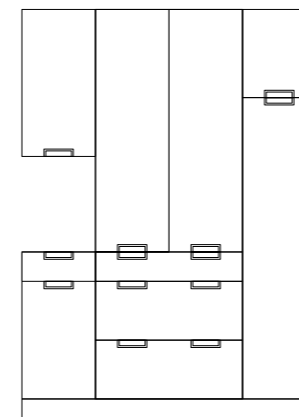

VOGUE LAMINATE DOOR:



LAMINATE
BONDI

DOOR STYLE SPECIFICATIONS:

DOOR CONSTRUCTION:

-Laminate Panel door with Slim Shaker Moulding.

MINIMUM SIZE:

-3"W x 3"H.

-Subject to cabinet minimums.

MAXIMUM SIZE:

-24"W x 61 1/2"H.

-Larger doors will be multiple doors pinned together.

GLASS DOORS:

-1LITE Frames only.

-Mullions not available.

WAINSCOT PANELS:

-Not available.

DOOR MATCH FILLERS/PILASTERS:

- Available.

GRAIN-MATCHING:

-Not available.

FINISHES AVAILABLE:

- BONDI
- COPACABANA
- NAVAGIO
- TULUM
- VERADERO
- WHITEHAVEN

DOOR PROFILE:

DOOR PROFILE

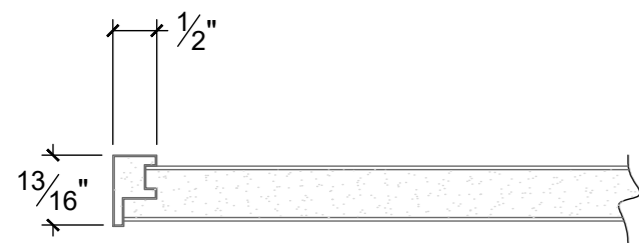

1LITE FRAME RAIL & MULLION PROFILES

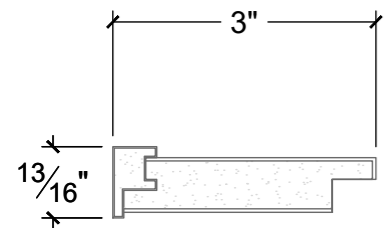

SMALL DRAWER FRONT OPTIONS (6"H):

DOOR MATCH

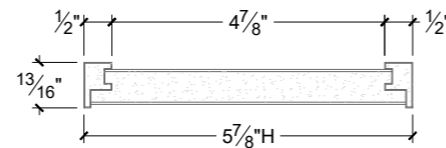
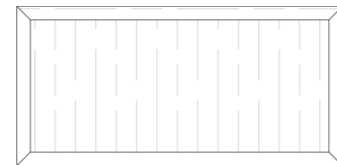

MINIMUM SIZE:

-3"W X 3"H

LARGE DRAWER FRONT OPTIONS:

DOOR MATCH

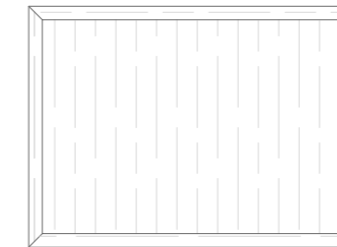



FINISHES

INTERIOR FINISHES

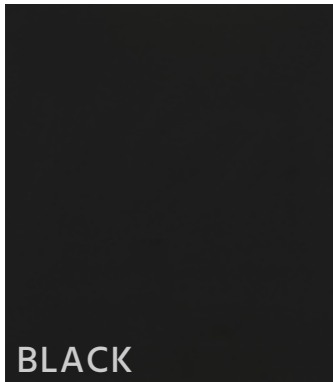

MATERIAL:
-Laminate
-Particle Core
CONSTRUCTION:
-5/8"Th Construction



MATERIAL:
-Laminate
-Particle Core
CONSTRUCTION:
-3/4"Th Construction



MATERIAL:
-Laminate
-Particle Core
CONSTRUCTION:
-5/8"Th Construction
-3/4"Th Construction



MATERIAL:
-Laminate
-Particle Core
CONSTRUCTION:
-5/8"Th Construction
-3/4"Th Construction
FEATURES:
-Matches LEGRABOX
Orion Grey drawers.

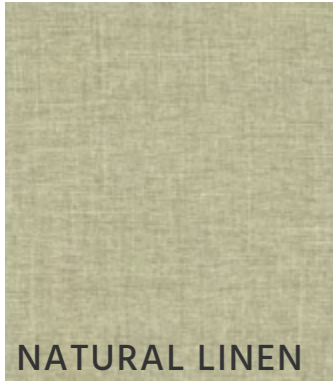

MATERIAL:
-Laminate
-Particle Core
CONSTRUCTION:
-5/8"Th Construction
-3/4"Th Construction

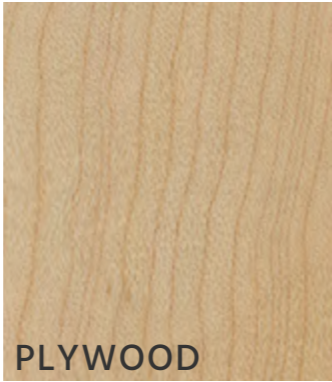

MATERIAL:
-Birch Veneer with
Clear Top Coat
-Plywood Core
CONSTRUCTION:
-3/4"Th Construction

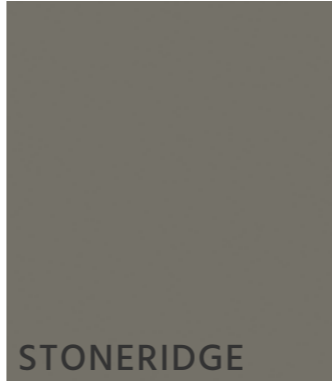

MATERIAL:
-Laminate
-Particle Core
CONSTRUCTION:
-5/8"Th Construction
-3/4"Th Construction
FEATURES:
-Matches TANDEMBOX
Grey & MERIVOBX
Grey drawers.

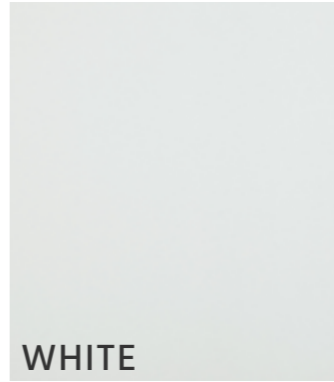

MATERIAL:
-Laminate
-Particle Core
CONSTRUCTION:
-5/8"Th Construction
-3/4"Th Construction
FEATURES:
-Matches TANDEMBOX,
MERIVOBX & LEGRABOX
White drawers.

STAIN FINISHES

All our stains come standard with a matte sheen. Satin & Classic are available upon request & must be noted on the order. Backs of doors will be finished in the base stain only (no shader) & will not match the face. A finished sample should be viewed as colours may appear differently on screen or print & will vary by wood species.

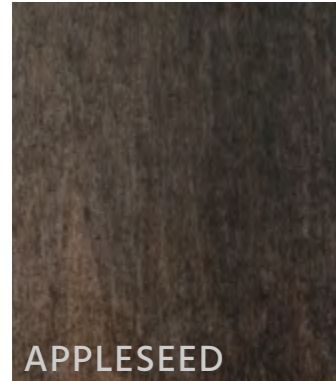

SPECIES AVAILABILITY:
-Alder
-Cherry
-Maple
-Oak, Red
-Oak, White

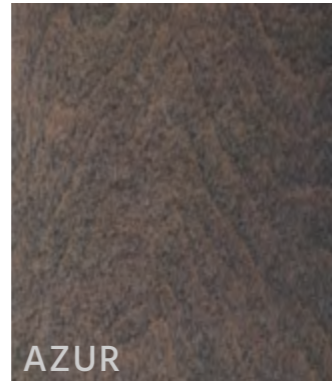

SPECIES AVAILABILITY:
-Alder
-Cherry
-Maple
-Oak, Red
-Oak, White

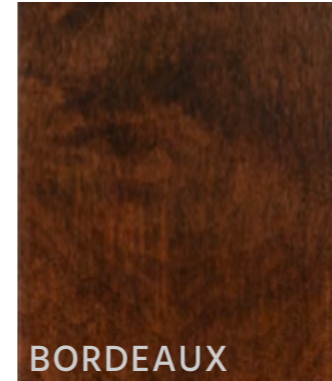

SPECIES AVAILABILITY:
-Alder
-Cherry
-Maple
-Oak, Red
-Oak, White

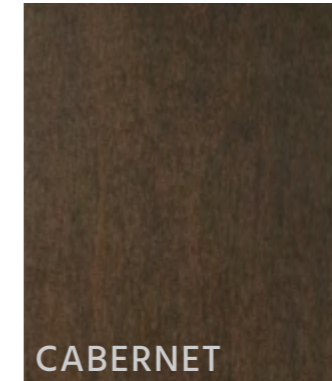

SPECIES AVAILABILITY:
-Alder
-Cherry
-Maple
-Oak, Red
-Oak, White
-Walnut

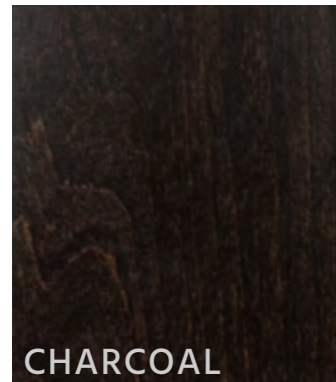

SPECIES AVAILABILITY:
-Alder
-Cherry
-Maple
-Oak, Red
-Oak, White

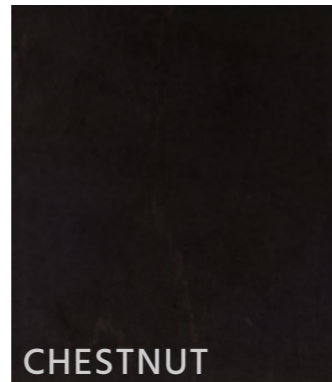

SPECIES AVAILABILITY:
-Alder
-Cherry
-Maple
-Oak, Red
-Oak, White

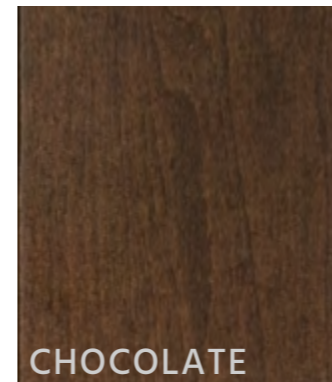

SPECIES AVAILABILITY:
-Alder
-Cherry
-Maple
-Oak, Red
-Oak, White
-Walnut

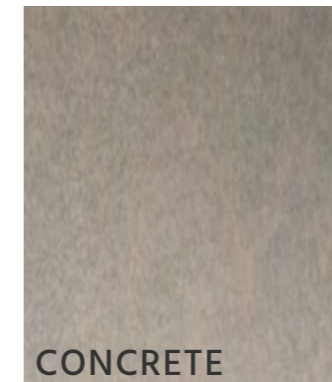

SPECIES AVAILABILITY:
-Maple
-Oak, Red
-Oak, White

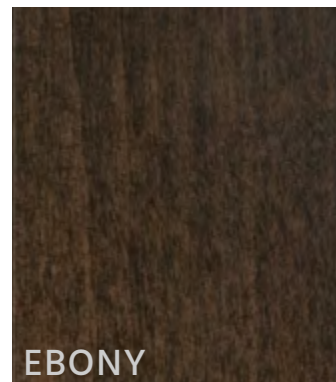

SPECIES AVAILABILITY:
-Maple
-Oak, Red
-Oak, White
-Walnut

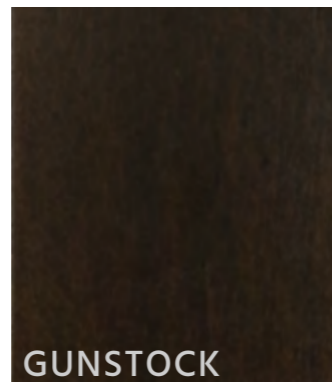

SPECIES AVAILABILITY:
-Alder
-Cherry
-Maple
-Oak, Red
-Oak, White
-Walnut

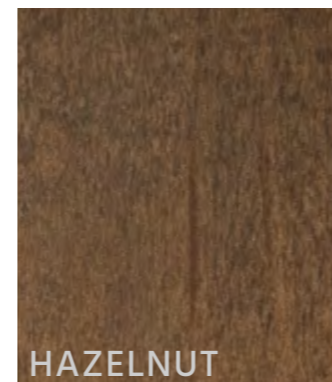

SPECIES AVAILABILITY:
-Alder
-Cherry
-Maple
-Oak, Red
-Oak, White

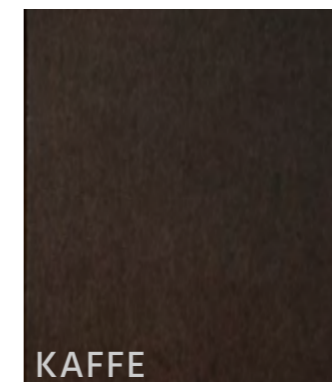

SPECIES AVAILABILITY:
-Alder
-Cherry
-Maple
-Oak, Red
-Oak, White

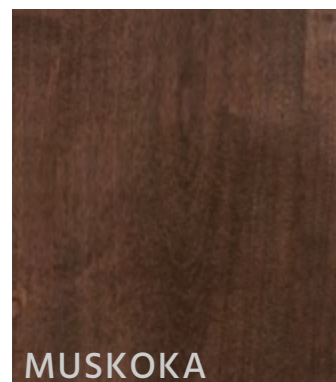

SPECIES AVAILABILITY:
-Alder
-Cherry
-Maple
-Oak, Red
-Oak, White

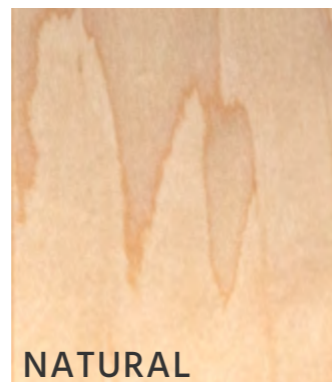

SPECIES AVAILABILITY:
-Alder
-Cherry
-Maple
-Oak, Red
-Oak, White
-Walnut

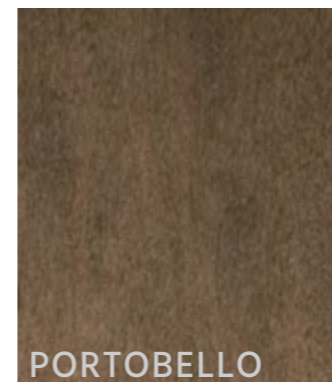

SPECIES AVAILABILITY:
-Alder
-Cherry
-Maple
-Oak, Red
-Oak, White

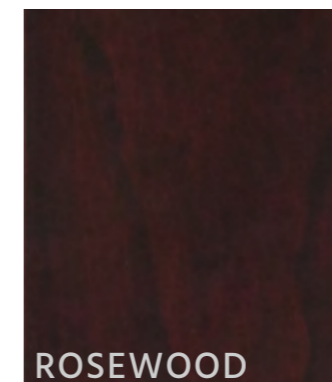

SPECIES AVAILABILITY:
-Alder
-Cherry
-Maple
-Oak, Red
-Oak, White

STAIN FINISHES

All our stains come standard with a matte sheen. Satin & Classic are available upon request & must be noted on the order. Backs of doors will be finished in the base stain only (no shader) & will not match the face. A finished sample should be viewed as colours may appear differently on screen or print & will vary by wood species.

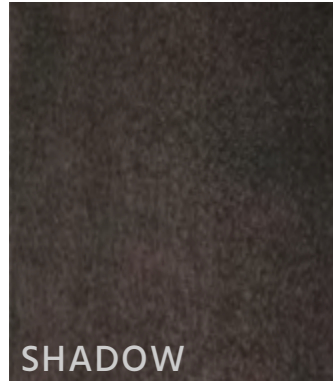

SPECIES AVAILABILITY:

- Alder
- Cherry
- Maple
- Oak, Red
- Oak, White
- Walnut

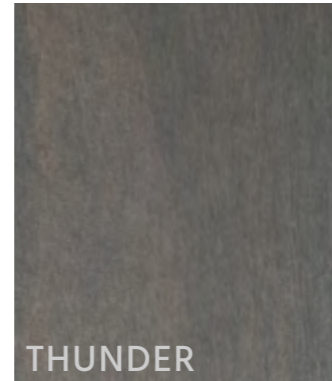

SPECIES AVAILABILITY:

- Alder
- Cherry
- Maple
- Oak, Red
- Oak, White
- Walnut

PAINT FINISHES

All our paints are available in a Matte or Satin sheen. The backs of doors will be finished to match the face. A finished sample should be viewed as colours may appear differently on screen or print.

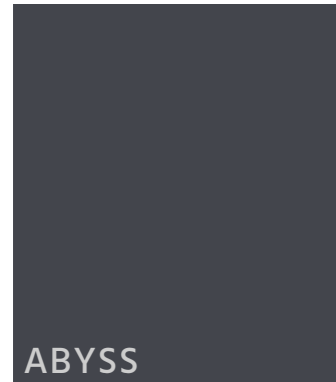

ABYSS

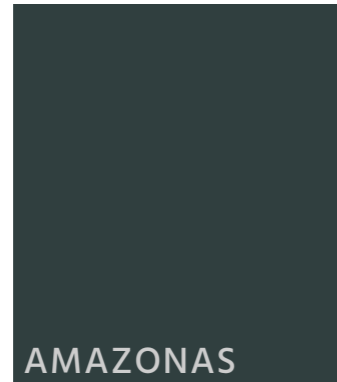

AMAZONAS

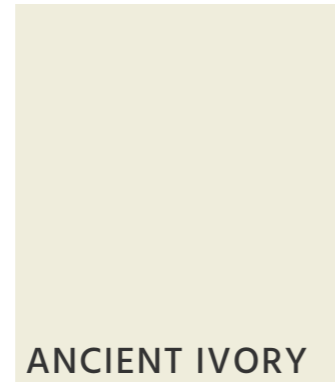

ANCIENT IVORY

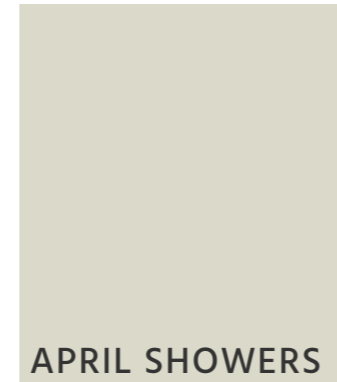

APRIL SHOWERS



ARCTIC SEAL



BALT BLUE



BLACK INK



BLISS



BOLD BLUE

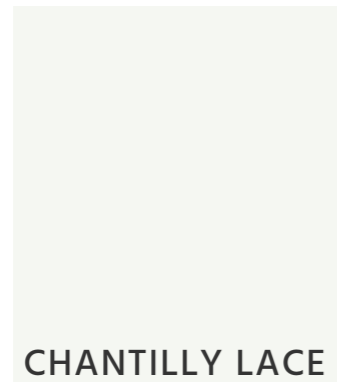

CHANTILLY LACE

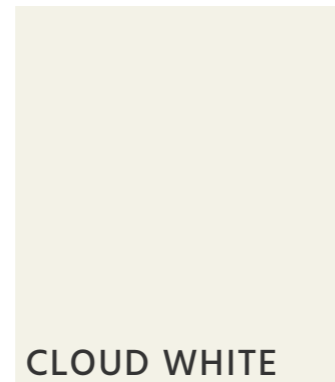

CLOUD WHITE

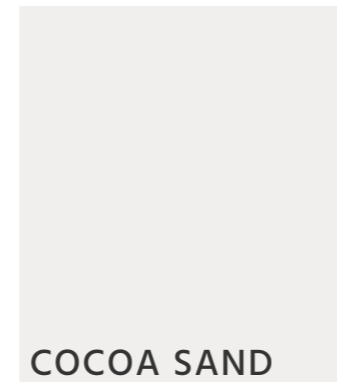

COCOA SAND



CORDOVAN



ECLIPSE



EVENTIDE

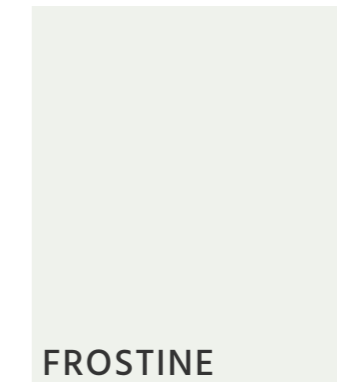

FROSTINE



HALF MOON
CRESCENT



HARBOURFRONT



HINT OF MINT



HUDSON BAY



IRON MOUNTAIN

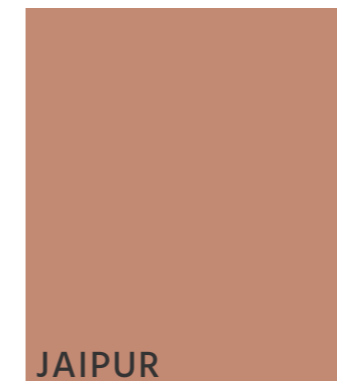

JAIPUR



KENDALL
CHARCOAL



LAKESHORE BLUE



LONDON FOG



MARIGOLD

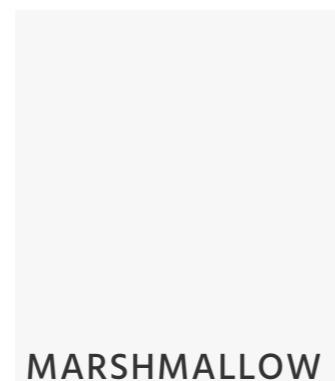

MARSHMALLOW



METROPOLITAN



MULBERRY

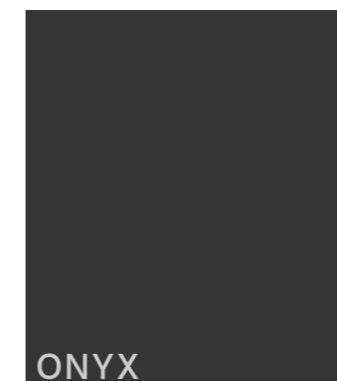

ONYX

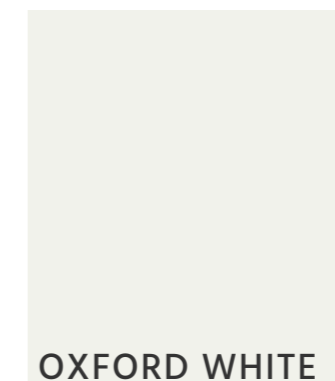

OXFORD WHITE



PISTACHIO

PAIN T FINISHES

All our paints are available in a Matte or Satin sheen. The backs of doors will be finished to match the face. A finished sample should be viewed as colours may appear differently on screen or print.

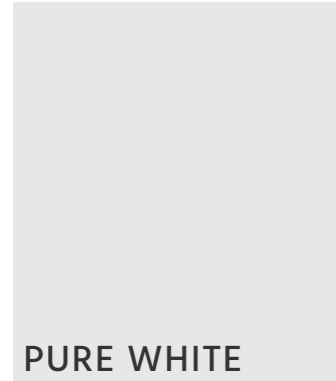

PURE WHITE

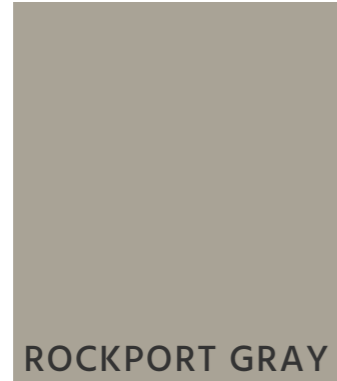

ROCKPORT GRAY

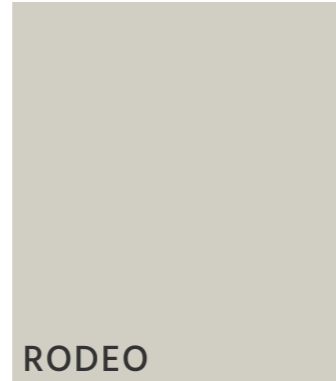

RODEO



SAGEBRUSH

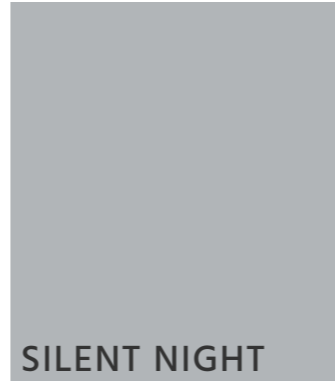

SILENT NIGHT



SILVER CHAIN

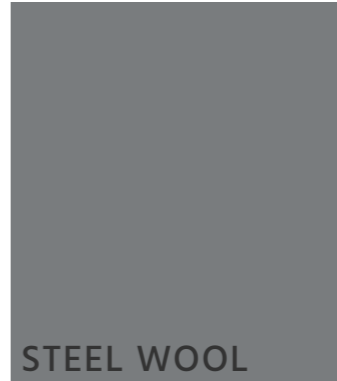

STEEL WOOL



STONINGTON
GREY



WANDERLUST



WROUGHT IRON

GLAZED FINISHES

All our glazes come standard with a matte sheen. Backs of doors will be finished in the base stain only & will not match the face. A finished sample should be viewed as colours may appear differently on screen or print & will vary by wood species & door style.

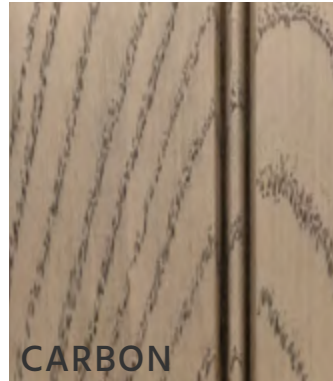

CARBON

SPECIES AVAILABILITY:
-Oak, White



GALAXY

SPECIES AVAILABILITY:
-Oak, White
-Walnut



MASALA

SPECIES AVAILABILITY:
-Alder
-Cherry
-Maple
-Oak, Red
-Oak, White
-Walnut

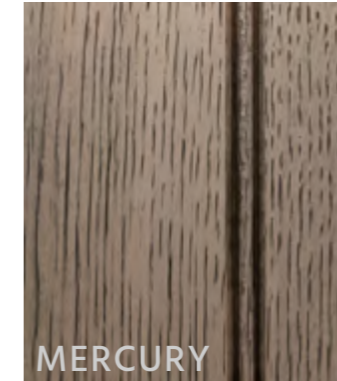

MERCURY

SPECIES AVAILABILITY:
-Oak, Red
-Oak, White
-Walnut



SAHARA

SPECIES AVAILABILITY:
-Oak, White



SANDY BEACH

SPECIES AVAILABILITY:
-Oak, White



WHITE GOLD

SPECIES AVAILABILITY:
-Oak, White

LAMINATE FINISHES

All our laminates are 3/4" thick Textured Melamines & come finished on both sides. Laminates are durable, easy to clean, & many of our finishes have anti-bacterial properties.



ACADIA



ASPEN



ASTORIA



AURORA



AVALON



BANCROFT



BONDI



BOREAL

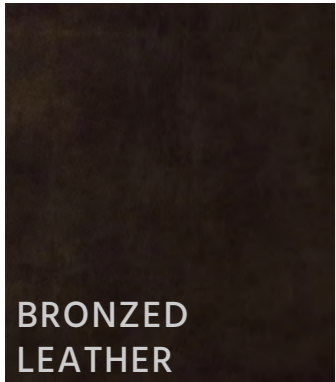

BRONZED LEATHER



CARACCA



CARAVELA



CHAMPLAIN



COPACABANA



DENALI



ELORA



FRONTENAC



KAWARTHA

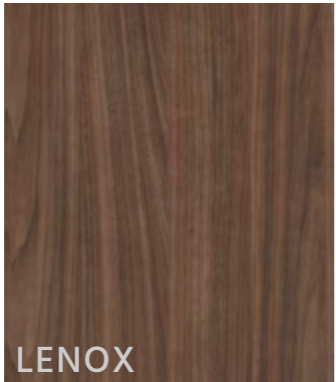

LENOX



NAVAGIO



OLYMPIA



OYSTER GREY LEATHER



OZARK



PETRA



QUERCUS



SARANAC

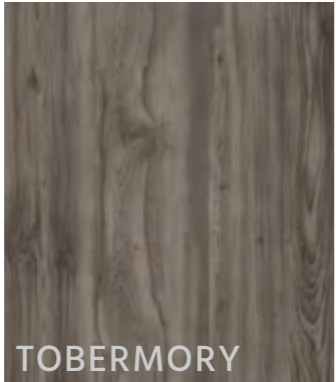

TOBERMORY



TULUM



VAIL



VERADERO

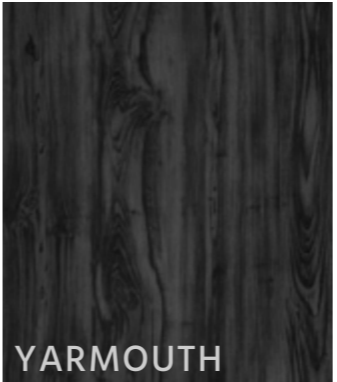

YARMOUTH

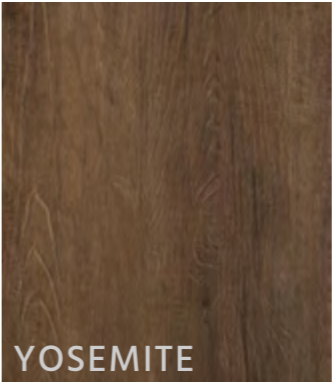

YOSEMITE



WHITEHAVEN

P.E.T. FINISHES

P.E.T. Panels are 18mm thick & finished on both sides.

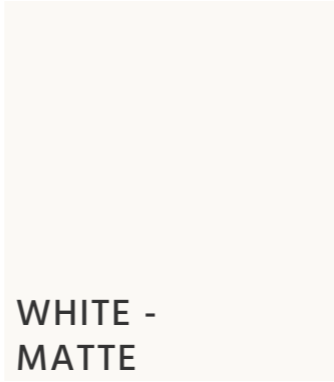
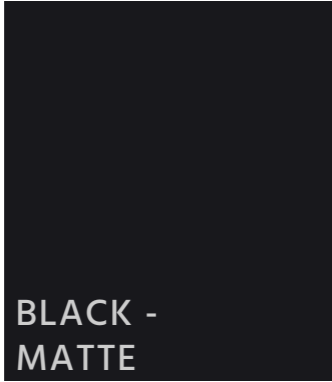
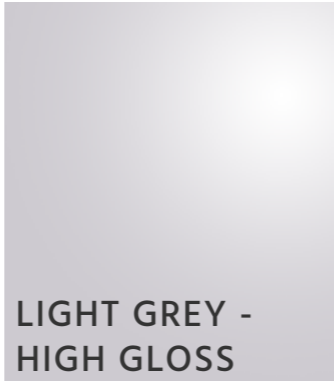
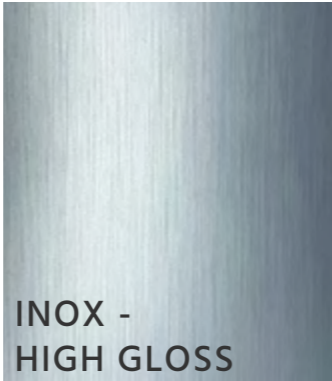
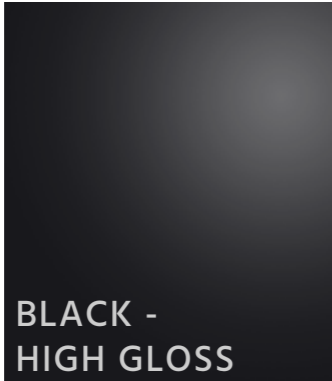



DRAWER BOXES & HINGES

DRAWER BOXES



DESCRIPTION:
- Solid hardwood Sides with a veneer bottom.

DRAWER GLIDES:
- Blum Movento Full Extension with Soft Close.
- Tip-On available as an upgrade.

FINISH:
- Clear coat sealer for a natural finish.

AVAILABLE HEIGHTS:
- 4"H
- 8 1/4"H



DESCRIPTION:
- Metal drawer sides with Square Gallery Rails on Large Drawers.

DRAWER GLIDES:
- Blumotion Full Extension with Soft Close.
- Tip-On available as an upgrade.

FINISH OPTIONS:
- Grey
- White

AVAILABLE HEIGHTS:
- 3 3/4"H
- 7"H

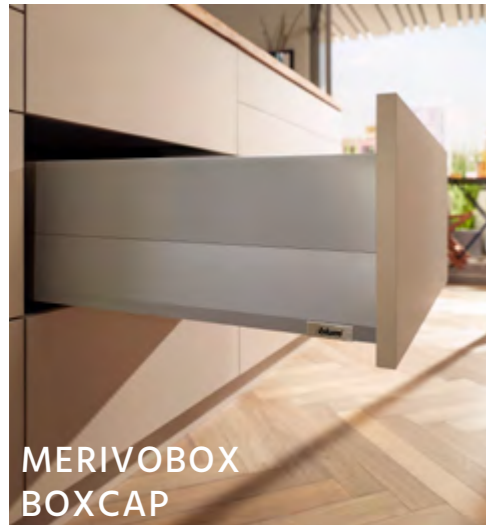

DESCRIPTION:
- Matte metal drawer sides with Box Cap metal sides.

DRAWER GLIDES:
- Blumotion Full Extension with Soft Close.
- Tip-On available as an upgrade.

FINISH OPTIONS:
- Grey
- Silk White

AVAILABLE HEIGHTS:
- 3 5/8"H
- 7 1/2"H



DESCRIPTION:
- Matte metal drawer sides with Square Gallery Rails on Large Drawers.

DRAWER GLIDES:
- Blumotion Full Extension with Soft Close.
- Tip-On available as an upgrade.

FINISH OPTIONS:
- Grey
- Silk White

AVAILABLE HEIGHTS:
- 3 5/8"H
- 7 1/2"H



DESCRIPTION:
- Matte metal drawer sides with Glass Sides on Large Drawers.

DRAWER GLIDES:
- Blumotion Full Extension with Soft Close.
- Tip-On available as an upgrade.

FINISH OPTIONS:
- Grey
- Silk White

AVAILABLE HEIGHTS:
- 3 5/8"H
- 7 1/2"H



DESCRIPTION:
- Matte metal drawer sides with full height metal sides.

DRAWER GLIDES:
- Legra Full Extension with Soft Close.
- Tip-On available as an upgrade.

FINISH OPTIONS:
- Orion Grey
- Silk White
- Stainless Steel

AVAILABLE HEIGHTS:
- 3 5/8"H
- 7"H



DESCRIPTION:
- Matte metal drawer sides with full height glass sides.

DRAWER GLIDES:
- Legra Full Extension with Soft Close.
- Tip-On available as an upgrade.

FINISH OPTIONS:
- Orion Grey
- Silk White
- Stainless Steel

AVAILABLE HEIGHTS:
- 3 5/8"H
- 7"H

HINGES



110° BLUMOTION

DESCRIPTION:

- 110° opening angle.
- Integral Blumotion Soft-Close.
- 3-way adjustment - Vertical, Horizontal, Depth.
- Default hinge for most cabinets. Certain cabinet shapes, such as angled cabinets, will receive suitable alternatives.

UPGRADES:

- Opening angle limiters.
- Tip-On for doors.

GENERAL HINGE SPECIFICATIONS:

SIZE:

- Minimum door height: 12"H (nominal).
- Minimum door rail: 2 1/4"W is required for hinge boring.

HINGE QUANTITY:

- The number of hinges is dependent on the height of the door. Please refer to drawing below. Doors over 66"H will receive 5 hinges.
- Certain scenarios may require extra hinges or modified hinge locations.

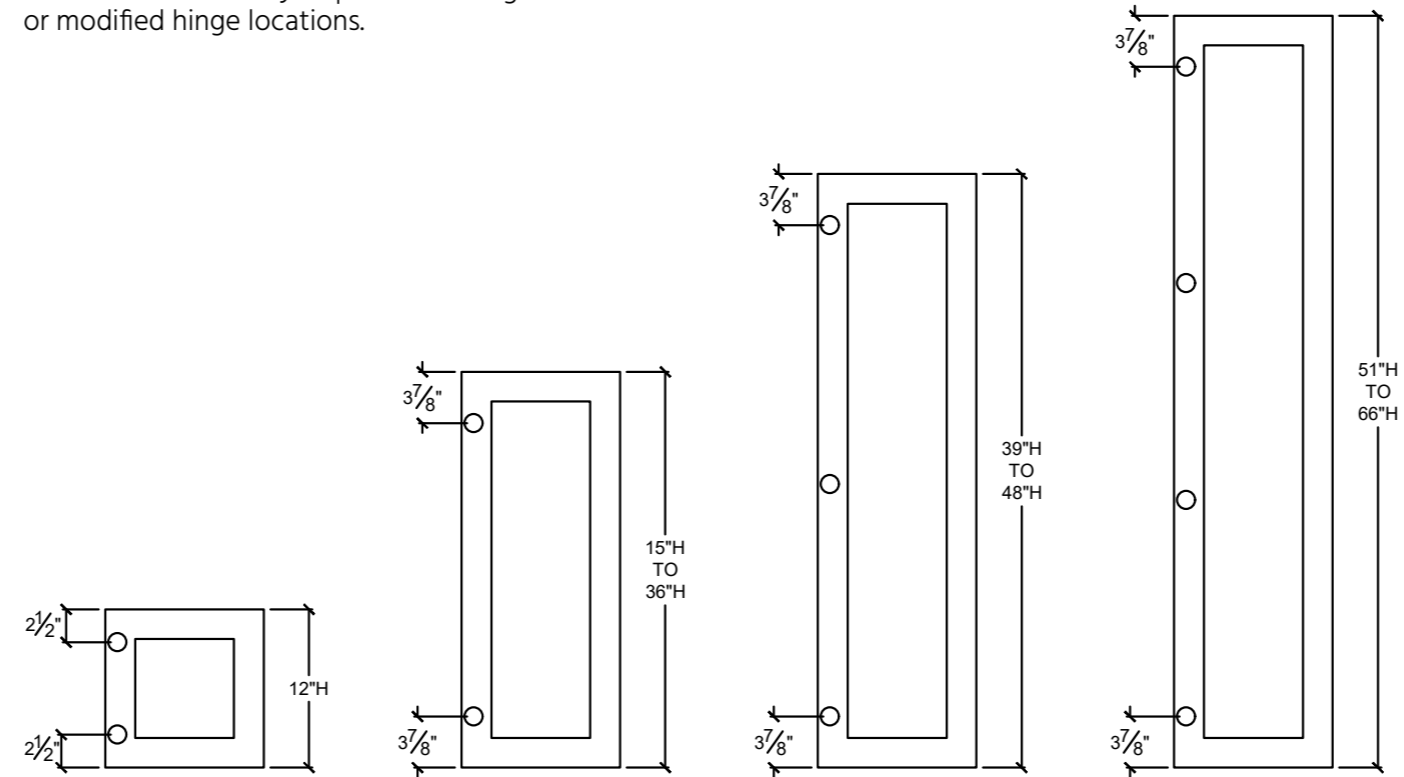

MOUNTING PLATE:

- A cruciform mounting plate is used as standard to allow for vertical hinge adjustment.



CABINETS

WALL CABINETS

W-W-H-D WALL CABINET:

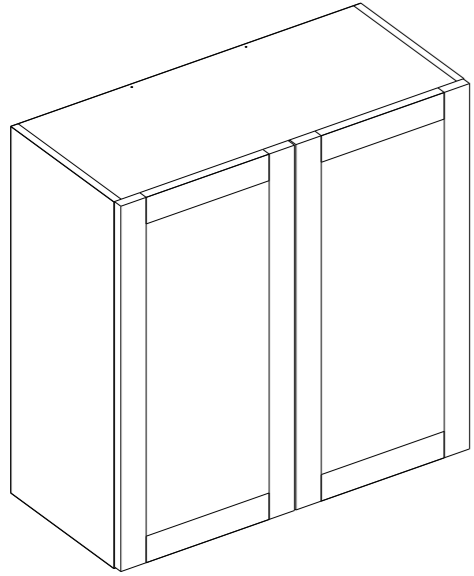

SPECIFICATIONS:

DESCRIPTION:

- Standard Wall Cabinet.

WIDTHS:

- 9"W to 42"W.

- Cabinets 24"W to 42"W will have 2 doors hinged Left & Right. For full width doors, select L or R hinging. Doors over 24"W will void warranty.

- 36"W+ cabinets will have shelf clips in the centre back of cabinet to support the shelves.

- Minimum Width: 6 1/2"W - See individual Door Style pages for Door limitations.

HEIGHTS:

- 12"H to 60"H.

DEPTHS:

- 12 3/4"D (13), 17 3/4"D (18), & 23 3/4"D (24).

- Minimum Depth: 4"D.

DOOR/CONFIGURATION HEIGHTS:

- Listed configuration height is nominal & doesn't take into account door reveals.

DOOR REVEALS:

- 1/16" reveals at top, bottom, & both sides of doors creating a 1/8" reveal between multiple fronts.

ADJUSTABLE SHELVES:

- The number of adjustable shelves is determined by the Configuration (door) height. See chart below.

DOOR HEIGHT	ADJUSTABLE SHELF QUANTITY
9"H TO 15"H	0
15 1/8"H TO 27"H	1
27 1/8"H TO 36"H	2
36 1/8"H TO 42"H	3
42 1/8"H TO 54"H	4
54 1/8"H TO 60"H	5

WW-H-DSTK WALL CABINET STACK:

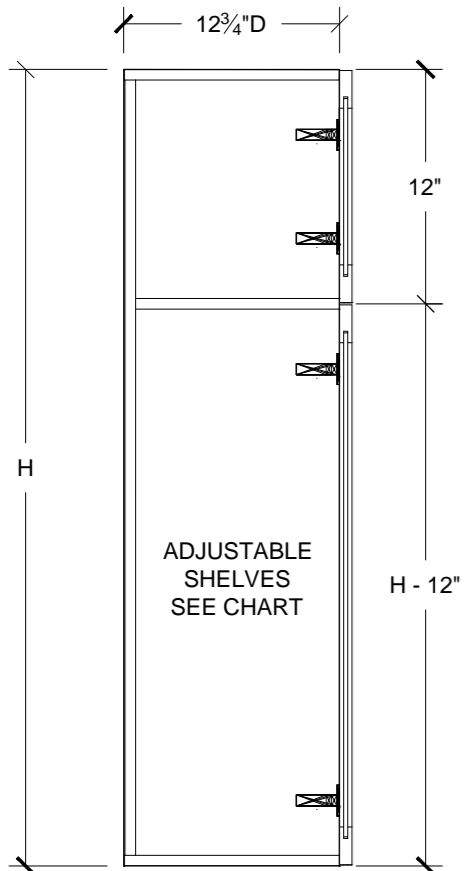
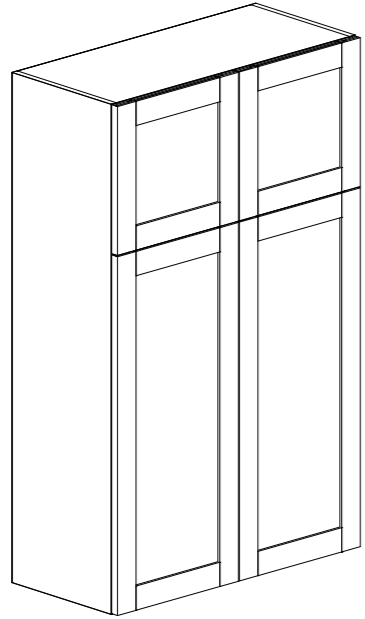

SPECIFICATIONS:

DESCRIPTION:

-12"H Top Section with Fixed Shelf between doors.

WIDTHS:

-9"W to 42"W.

-Cabinets 24"W to 42"W will have 2 doors hinged Left & Right. For full width doors, select L or R hinging. Doors over 24"W will void warranty.

-36"W+ cabinets will have shelf clips in the centre back of cabinet to support the shelves.

-Minimum Width: 6 1/2"W - See individual Door Style pages for Door limitations.

HEIGHTS:

-24"H to 60"H.

-Doors smaller than 12"H (nominal) cannot be hinged.

DEPTHS:

-12 3/4"D (13), 17 3/4"D (18), & 23 3/4"D (24).

-Minimum Depth: 4"D.

DOOR/CONFIGURATION HEIGHTS:

-Listed configuration height is nominal & doesn't take into account door reveals.

-Door/Configuration Heights can be modified, a MODIFY DOORH CONFIG charge will apply.

DOOR REVEALS:

-1/16" reveals at top, bottom, & both sides of doors creating a 1/8" reveal between multiple fronts.

ADJUSTABLE SHELVES:

-The number of adjustable shelves is determined by the Configuration (door) height. See chart below.

NOTES:

-If a Finished Interior modification is added, the entire interior will be finished.

DOOR HEIGHT	ADJUSTABLE SHELF QUANTITY
9"H TO 15"H	0
15 1/8"H TO 27"H	1
27 1/8"H TO 36"H	2
36 1/8"H TO 42"H	3
42 1/8"H TO 54"H	4
54 1/8"H TO 60"H	5

WW-H-DDR1 WALL CABINET WITH 1 DRAWER:

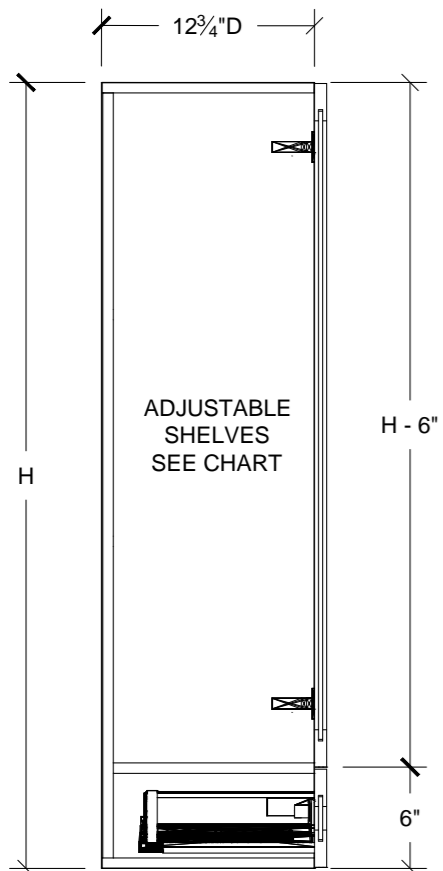
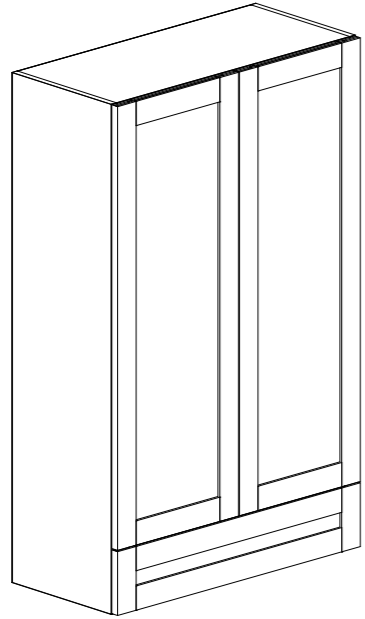

SPECIFICATIONS:

DESCRIPTION:

-1 - 6"H Full Width Drawer.

WIDTHS:

-9"W to 42"W.

-Cabinets 24"W to 42"W will have 2 doors hinged Left & Right. For full width doors, select L or R hinging. Doors over 24"W will void warranty.

-36"W+ cabinets will have shelf clips in the centre back of cabinet to support the shelves.

-Minimum Width with Dovetail Drawers: 11 1/2"W.

-See individual Door Style pages for Door limitations.

HEIGHTS:

-48"H to 60"H.

-Doors smaller than 12"H (nominal) cannot be hinged.

DEPTHS:

-12 3/4"D (13), 17 3/4"D (18), & 23 3/4"D (24).

-Minimum Depth: 12 3/4"D.

DOOR/CONFIGURATION HEIGHTS:

-Listed configuration height is nominal & doesn't take into account door reveals.

-Door/Configuration Heights can be modified, a MODIFY DOORH CONFIG charge will apply.

DOOR REVEALS:

-1/16" reveals at top, bottom, & both sides of doors creating a 1/8" reveal between multiple fronts.

ADJUSTABLE SHELVES:

-The number of adjustable shelves is determined by the Configuration (door) height. See chart below.

NOTES:

-If a Finished Interior modification is added, the entire interior will be finished (drawer box excluded).

DOOR HEIGHT	ADJUSTABLE SHELF QUANTITY
9"H TO 15"H	0
15 1/8"H TO 27"H	1
27 1/8"H TO 36"H	2
36 1/8"H TO 42"H	3
42 1/8"H TO 54"H	4
54 1/8"H TO 60"H	5

WW-H-DDR1STK WALL CABINET STACK WITH 1 DRAWER:

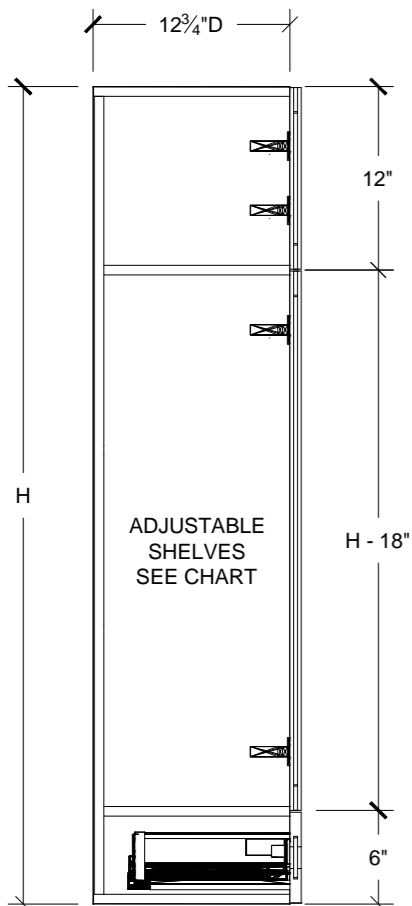
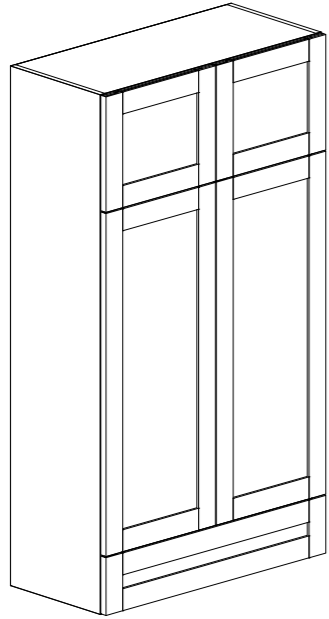

SPECIFICATIONS:

DESCRIPTION:

-12"H Top Section with Fixed Shelf between doors & 1 - 6"H Full Width Drawer.

WIDTHS:

-9"W to 42"W.

-Cabinets 24"W to 42"W will have 4 doors hinged Left & Right. For full width doors, select L or R hinging. Doors over 24"W will void warranty.

-36"W+ cabinets will have shelf clips in the centre back of cabinet to support the shelves.

-Minimum Width with Dovetail Drawers: 11 1/2"W.

-See individual Door Style pages for Door limitations.

HEIGHTS:

-48"H to 60"H.

-Doors smaller than 12"H (nominal) cannot be hinged.

DEPTHS:

-12 3/4"D (13), 17 3/4"D (18), & 23 3/4"D (24).

-Minimum Depth: 12 3/4"D.

DOOR/CONFIGURATION HEIGHTS:

-Listed configuration height is nominal & doesn't take into account door reveals.

-Door/Configuration Heights can be modified, a MODIFY DOORH CONFIG charge will apply.

DOOR REVEALS:

-1/16" reveals at top, bottom, & both sides of doors creating a 1/8" reveal between multiple fronts.

ADJUSTABLE SHELVES:

-The number of adjustable shelves is determined by the Configuration (door) height. See chart below.

NOTES:

-If a Finished Interior modification is added, the entire interior will be finished (drawer box excluded).

DOOR HEIGHT	ADJUSTABLE SHELF QUANTITY
9"H TO 15"H	0
15 1/8"H TO 27"H	1
27 1/8"H TO 36"H	2
36 1/8"H TO 42"H	3
42 1/8"H TO 54"H	4
54 1/8"H TO 60"H	5

WW-H-DDR2 WALL CABINET WITH 2 DRAWERS:

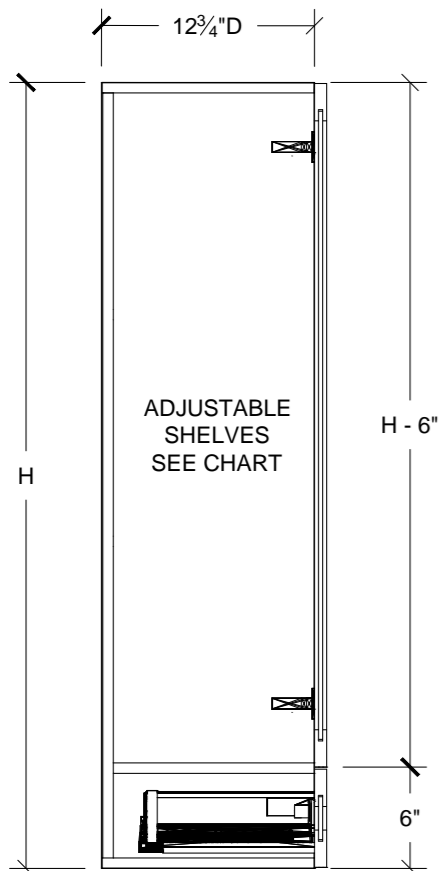
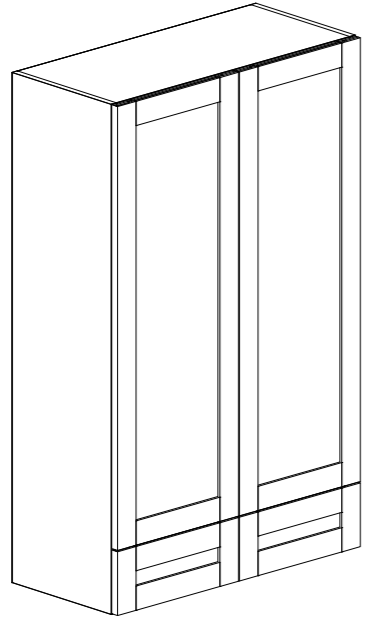

SPECIFICATIONS:

DESCRIPTION:

-2 - 6"H Drawers.

WIDTHS:

-24"W to 42"W.

-Cabinets will have 2 doors hinged Left & Right.

-36"W+ cabinets will have shelf clips in the centre back of cabinet to support the shelves.

HEIGHTS:

-48"H to 60"H.

-Doors smaller than 12"H (nominal) cannot be hinged.

DEPTHS:

-12 3/4"D (13), 17 3/4"D (18), & 23 3/4"D (24).

-Minimum Depth: 12 3/4"D.

DOOR/CONFIGURATION HEIGHTS:

-Listed configuration height is nominal & doesn't take into account door reveals.

-Door/Configuration Heights can be modified, a MODIFY DOORH CONFIG charge will apply.

DOOR REVEALS:

-1/16" reveals at top, bottom, & both sides of doors creating a 1/8" reveal between multiple fronts.

ADJUSTABLE SHELVES:

-The number of adjustable shelves is determined by the Configuration (door) height. See chart below.

NOTES:

-If a Finished Interior modification is added, the entire interior will be finished (drawer box excluded).

DOOR HEIGHT	ADJUSTABLE SHELF QUANTITY
9"H TO 15"H	0
15 1/8"H TO 27"H	1
27 1/8"H TO 36"H	2
36 1/8"H TO 42"H	3
42 1/8"H TO 54"H	4
54 1/8"H TO 60"H	5

WW-H-DDR2STK WALL CABINET STACK WITH 2 DRAWERS:

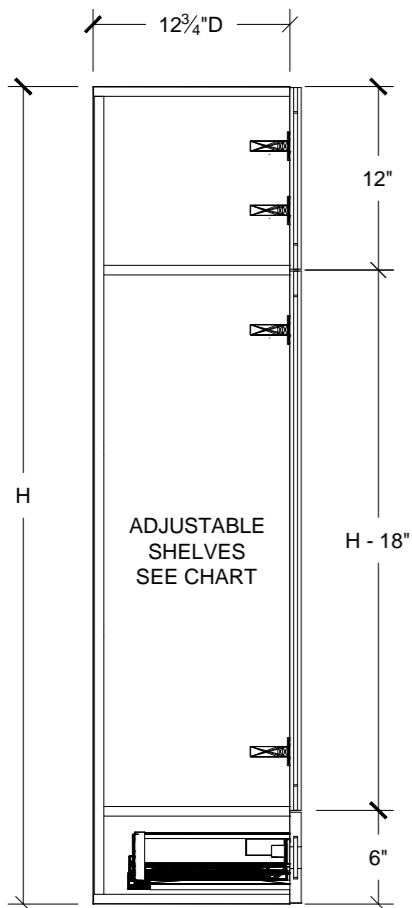
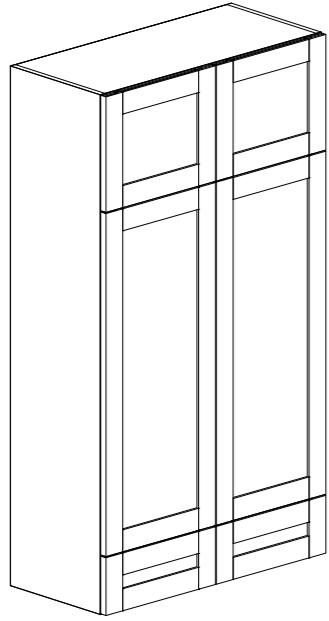

SPECIFICATIONS:

DESCRIPTION:

-12"H Top Section with Fixed Shelf between doors & 2 - 6"H Drawers.

WIDTHS:

-24"W to 42"W.

-Cabinets will have 4 doors hinged Left & Right. For full width doors, select L or R hinging. Doors over 24"W will void warranty.

-36"W+ cabinets will have shelf clips in the centre back of cabinet to support the shelves.

-Minimum Width with Dovetail Drawers: 11 1/2"W.

-See individual Door Style pages for Door limitations.

HEIGHTS:

-48"H to 60"H.

-Doors smaller than 12"H (nominal) cannot be hinged.

DEPTHS:

-12 3/4"D (13), 17 3/4"D (18), & 23 3/4"D (24).

-Minimum Depth: 12 3/4"D.

DOOR/CONFIGURATION HEIGHTS:

-Listed configuration height is nominal & doesn't take into account door reveals.

-Door/Configuration Heights can be modified, a MODIFY DOORH CONFIG charge will apply.

DOOR REVEALS:

-1/16" reveals at top, bottom, & both sides of doors creating a 1/8" reveal between multiple fronts.

ADJUSTABLE SHELVES:

-The number of adjustable shelves is determined by the Configuration (door) height. See chart below.

NOTES:

-If a Finished Interior modification is added, the entire interior will be finished (drawer box excluded).

DOOR HEIGHT	ADJUSTABLE SHELF QUANTITY
9"H TO 15"H	0
15 1/8"H TO 27"H	1
27 1/8"H TO 36"H	2
36 1/8"H TO 42"H	3
42 1/8"H TO 54"H	4
54 1/8"H TO 60"H	5

WW-H-DDR3 WALL CABINET WITH 3 DRAWERS:

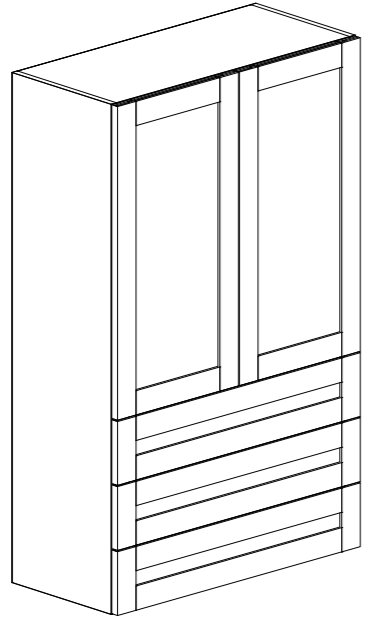

SPECIFICATIONS:

DESCRIPTION:

-3 - 6"H Full Drawers.

WIDTHS:

-24"W to 42"W.

-Cabinets 24"W to 42"W will have 2 doors hinged Left & Right. For full width doors, select L or R hinging. Doors over 24"W will void warranty.

-36"W+ cabinets will have shelf clips in the centre back of cabinet to support the shelves.

HEIGHTS:

-48"H to 60"H.

-Doors smaller than 12"H (nominal) cannot be hinged.

DEPTHS:

-12 3/4"D (13), 17 3/4"D (18), & 23 3/4"D (24).

-Minimum Depth: 12 3/4"D.

DOOR/CONFIGURATION HEIGHTS:

-Listed configuration height is nominal & doesn't take into account door reveals.

-Door/Configuration Heights can be modified, a MODIFY DOORH CONFIG charge will apply.

DOOR REVEALS:

-1/16" reveals at top, bottom, & both sides of doors creating a 1/8" reveal between multiple fronts.

ADJUSTABLE SHELVES:

-The number of adjustable shelves is determined by the Configuration (door) height. See chart below.

NOTES:

-If a Finished Interior modification is added, the entire interior will be finished (drawer box excluded).

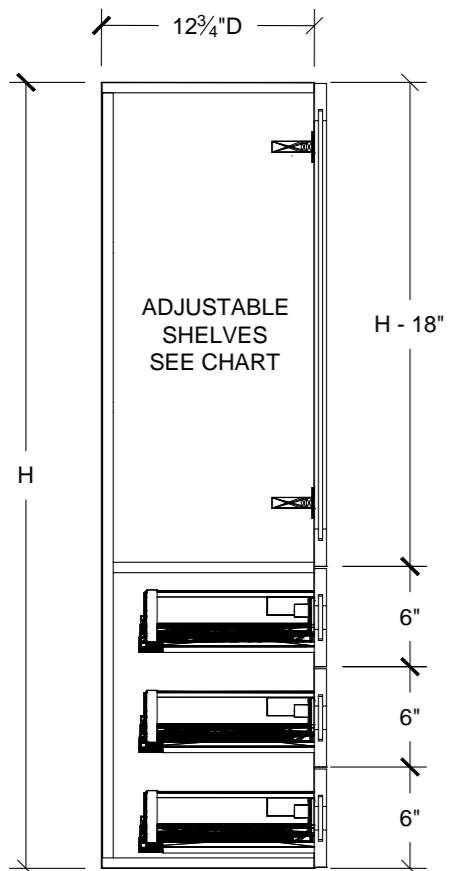

DOOR HEIGHT	ADJUSTABLE SHELF QUANTITY
9"H TO 15"H	0
15 1/8"H TO 27"H	1
27 1/8"H TO 36"H	2
36 1/8"H TO 42"H	3
42 1/8"H TO 54"H	4
54 1/8"H TO 60"H	5

WW-H-DDR3STK WALL CABINET STACK WITH 3 DRAWERS:

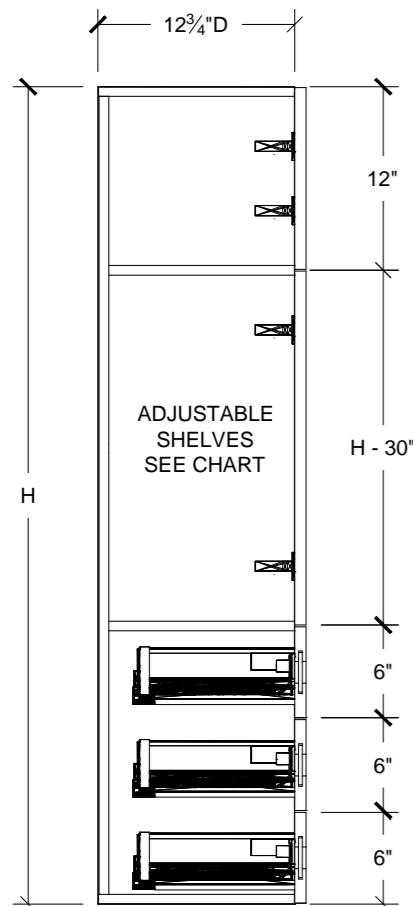
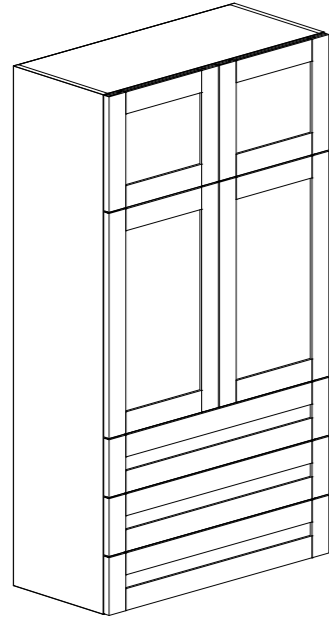

SPECIFICATIONS:

DESCRIPTION:

-12"H Top Section with Fixed Shelf between doors & 3 - 6"H Drawers.

WIDTHS:

-24"W to 42"W.

-Cabinets 24"W to 42"W will have 4 doors hinged Left & Right. For full width doors, select L or R hinging. Doors over 24"W will void warranty.

-36"W+ cabinets will have shelf clips in the centre back of cabinet to support the shelves.

HEIGHTS:

-48"H to 60"H.

-Doors smaller than 12"H (nominal) cannot be hinged.

DEPTHS:

-12 3/4"D (13), 17 3/4"D (18), & 23 3/4"D (24).

-Minimum Depth: 12 3/4"D.

DOOR/CONFIGURATION HEIGHTS:

-Listed configuration height is nominal & doesn't take into account door reveals.

-Door/Configuration Heights can be modified, a MODIFY DOORH CONFIG charge will apply.

DOOR REVEALS:

-1/16" reveals at top, bottom, & both sides of doors creating a 1/8" reveal between multiple fronts.

ADJUSTABLE SHELVES:

-The number of adjustable shelves is determined by the Configuration (door) height. See chart below.

NOTES:

-If a Finished Interior modification is added, the entire interior will be finished (drawer box excluded).

DOOR HEIGHT	ADJUSTABLE SHELF QUANTITY
9"H TO 15"H	0
15 1/8"H TO 27"H	1
27 1/8"H TO 36"H	2
36 1/8"H TO 42"H	3
42 1/8"H TO 54"H	4
54 1/8"H TO 60"H	5

WW-H-DFUD WALL CABINET WITH FLIP UP DOOR:



SPECIFICATIONS:

DESCRIPTION:

- Wall Cabinet with Aventos HK Top Hardware.
- White interiors will have White Cover Caps. All others will have Light Grey.

FEATURES:

- Door stays open at any angle up to 107°.
- Integrated opening angle stop allows maximum opening to be reduced if above clearance is limited.
- Built in BLUMOTION for silent closing.

WIDTHS:

- 12"W to 42"W.
- 36"W+ cabinets will have shelf clips in the centre back of cabinet to support the shelves.
- Minimum Width: 6 1/2"W - See individual Door Style pages for Door limitations.

HEIGHTS:

- 12"H to 21"H.
- Minimum Height: 8 1/2"H.

DEPTHS:

- 12 3/4"D (13), 17 3/4"D (18), & 23 3/4"D (24).
- Minimum Depth: 9 1/2"D.

DOOR REVEALS:

- 1/16" reveals at top, bottom, & both sides of doors creating a 1/8" reveal between multiple fronts.

ADJUSTABLE SHELVES:

- The number of adjustable shelves is determined by the Configuration (section) height. See chart below.

NOTES:

- Upgrade to Servo Drive available.
- For hardware adjustment, refer to: <https://youtu.be/qE7djbKlfH0>

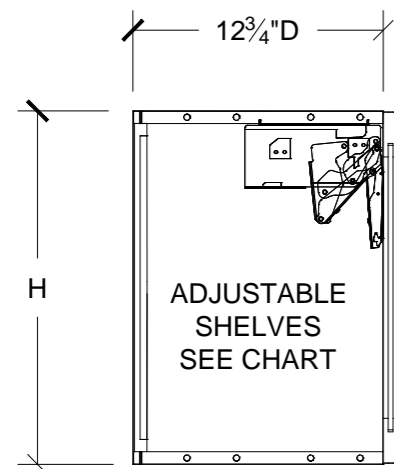

DOOR HEIGHT	ADJUSTABLE SHELF QUANTITY
9"H TO 15"H	0
18"H TO 21"H	1

WW-H-DPO WALL CABINET WITH WOOD PULL-OUT:



SPECIFICATIONS:

DESCRIPTION:

- Wall Cabinet with Maple Pull-Out

FEATURES:

- 2 - Middle shelves are adjustable.
- Each shelf has chrome-finished railings.
- Pull-Out glides are soft-close.
- Maximum weight capacity: 100 lbs.

WIDTHS:

- 9"W to 12"W.

HEIGHTS:

- 36"H to 39"H.

DEPTHS:

- 12 3/4"D

- Minimum Depth: 12"D.

DOOR REVEALS:

- 1/16" reveals at top, bottom, & both sides of doors creating a 1/8" reveal between multiple fronts.

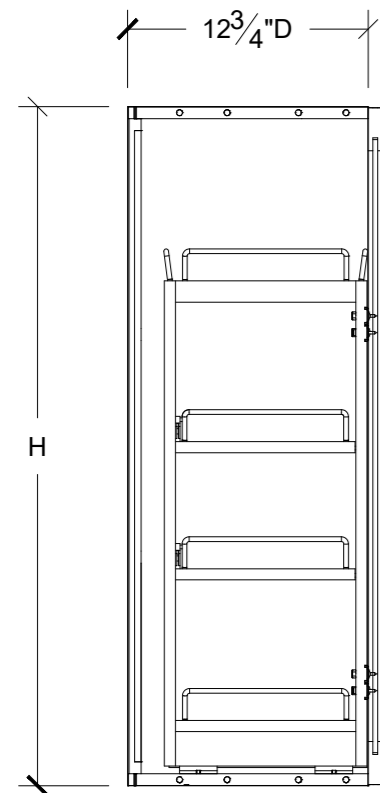

WW-H-DMW15 WALL MICROWAVE CABINET WITH 15"D SHELF:

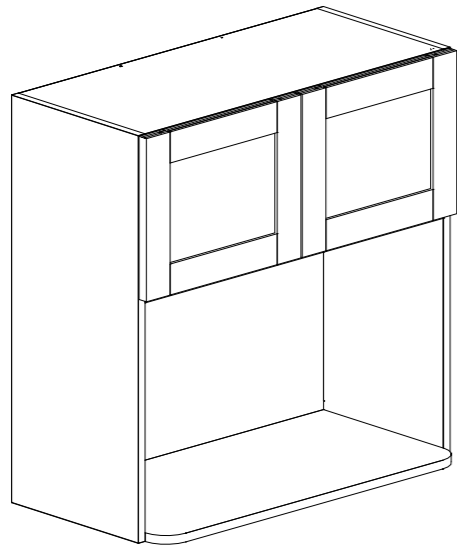

SPECIFICATIONS:

DESCRIPTION:

- Wall Cabinet with 18"H Open Shelf.
- Microwave Shelf (floor of cabinet) is 15"D.
- Entire interior of cabinet is finished to match doors.

WIDTHS:

- 21"W to 42"W.
- Cabinets 24"W to 42"W will have 2 doors hinged Left & Right. For full width doors, select L or R hinging. Doors over 24"W will void warranty.
- 36"W+ cabinets will have shelf clips in the centre back of cabinet to support any shelves.

HEIGHTS:

- 30"H to 60"H.
- Doors smaller than 12"H (nominal) cannot be hinged.

DEPTHS:

- 12 3/4"D (13).
- If cabinet depth is increased, the Microwave Shelf will increase as well.
- Minimum Depth: 4"D.

DOOR/CONFIGURATION HEIGHTS:

- Listed configuration height is nominal & doesn't take into account door reveals.

DOOR REVEALS:

- 1/16" reveals at top, bottom, & both sides of doors creating a 1/8" reveal between multiple fronts.

ADJUSTABLE SHELVES:

- The number of adjustable shelves is determined by the Configuration (door) height. See chart below.

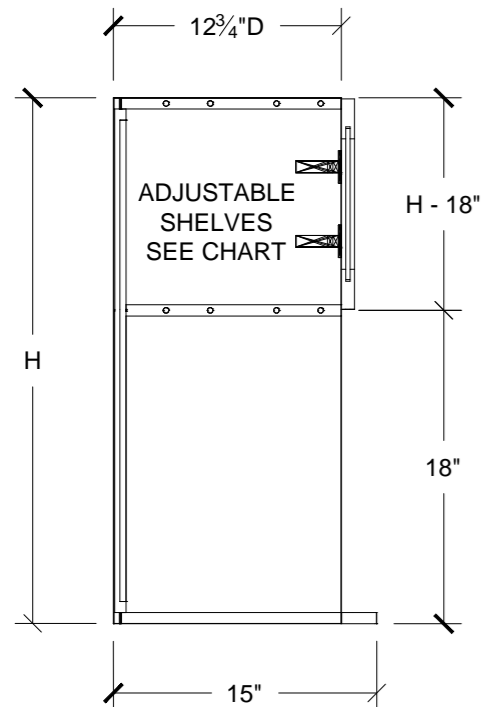

DOOR HEIGHT	ADJUSTABLE SHELF QUANTITY
9"H TO 15"H	0
15 1/8"H TO 27"H	1
27 1/8"H TO 36"H	2
36 1/8"H TO 42"H	3

WW-H-DMW18 WALL MICROWAVE CABINET WITH 18"D SHELF:

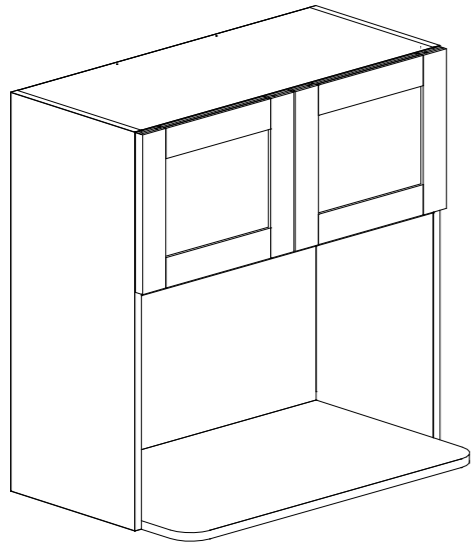

SPECIFICATIONS:

DESCRIPTION:

- Wall Cabinet with 18"H Open Shelf.
- Microwave Shelf (floor of cabinet) is 18"D.
- Entire interior of cabinet is finished to match doors.

WIDTHS:

- 21"W to 42"W.
- Cabinets 24"W to 42"W will have 2 doors hinged Left & Right. For full width doors, select L or R hinging. Doors over 24"W will void warranty.
- 36"W+ cabinets will have shelf clips in the centre back of cabinet to support any shelves.

HEIGHTS:

- 30"H to 60"H.
- Doors smaller than 12"H (nominal) cannot be hinged.

DEPTHS:

- 12 3/4"D (13).
- If cabinet depth is increased, the Microwave Shelf will increase as well.
- Minimum Depth: 4"D.

DOOR/CONFIGURATION HEIGHTS:

- Listed configuration height is nominal & doesn't take into account door reveals.

DOOR REVEALS:

- 1/16" reveals at top, bottom, & both sides of doors creating a 1/8" reveal between multiple fronts.

ADJUSTABLE SHELVES:

- The number of adjustable shelves is determined by the Configuration (door) height. See chart below.

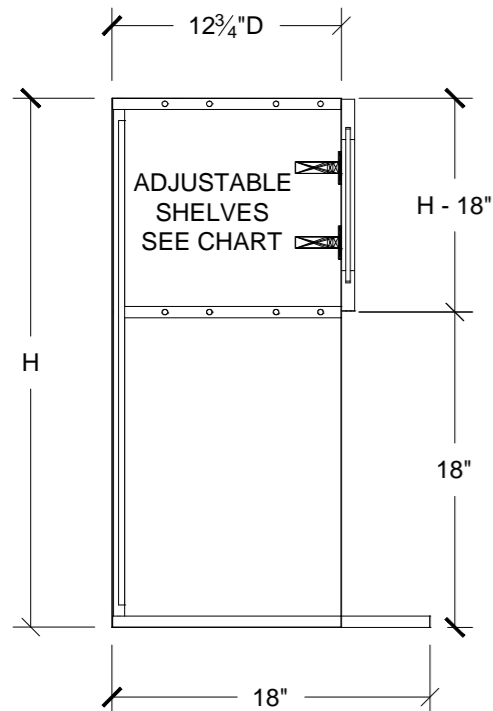

DOOR HEIGHT	ADJUSTABLE SHELF QUANTITY
9"H TO 15"H	0
15 1/8"H TO 27"H	1
27 1/8"H TO 36"H	2
36 1/8"H TO 42"H	3

90WCWL-WR-H-D WALL CABINET:

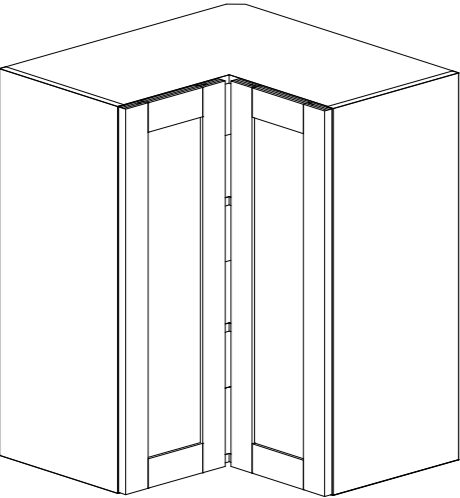

SPECIFICATIONS:

- DESCRIPTION:
 - Full Height Bi-fold Door Wall Cabinet.
- WIDTHS:
 - 21"W to 27"W.
 - Larger widths will void warranty on the hinges as doors will be prone to sagging.
- HEIGHTS:
 - 12"H to 48"H.
- DEPTHS:
 - 12 3/4"D (13).
 - Minimum Depth: Width - 15 1/4". Smaller depths will void warranty on the hinges as doors will be prone to sagging.
- DOOR/CONFIGURATION HEIGHTS:
 - Listed configuration height is nominal & doesn't take into account door reveals.
- DOOR REVEALS:
 - 1/16" reveals at top, bottom, & both sides of doors creating a 1/8" reveal between multiple fronts.
- ADJUSTABLE SHELVES:
 - The number of adjustable shelves is determined by the Configuration (door) height. See chart below.

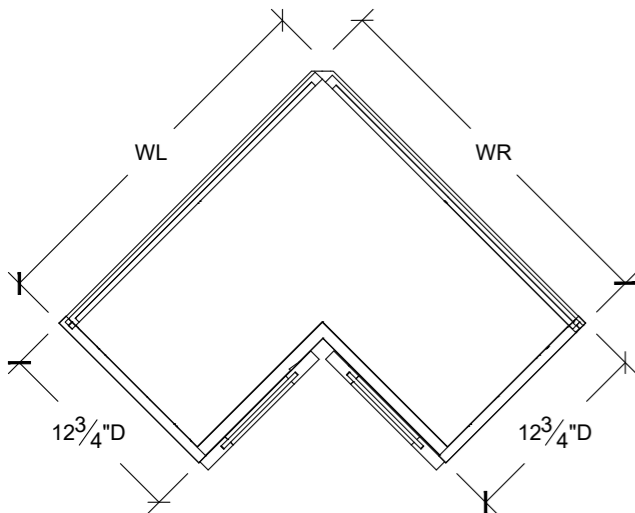

DOOR HEIGHT	ADJUSTABLE SHELF QUANTITY
9"H TO 15"H	0
15 1/8"H TO 27"H	1
27 1/8"H TO 36"H	2
36 1/8"H TO 42"H	3
42 1/8"H TO 54"H	4

90WCWL-WR-H-DSTK WALL CABINET:

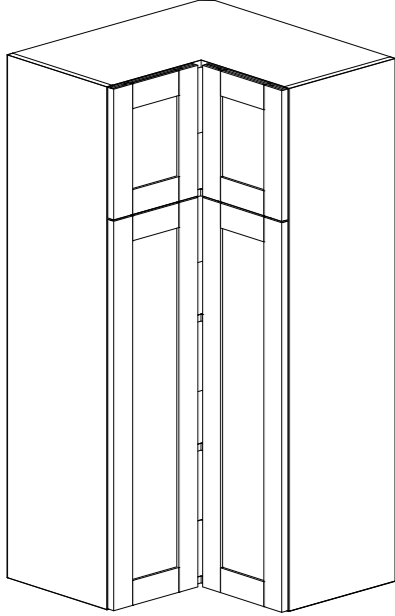

SPECIFICATIONS:

DESCRIPTION:

-Bi-fold Door Wall Cabinet with 12”H Top Section & Fixed Shelf between doors.

WIDTHS:

-21”W to 27”W.
 -Larger widths will void warranty on the hinges as doors will be prone to sagging.

HEIGHTS:

-48”H to 60”H.

DEPTHS:

-12 3/4”D (13).
 -Minimum Depth: Width - 15 1/4”. Smaller depths will void warranty on the hinges as doors will be prone to sagging.

DOOR/CONFIGURATION HEIGHTS:

-Listed configuration height is nominal & doesn’t take into account door reveals.
 -Door/Configuration Heights can be modified, a MODIFY DOORH CONFIG charge will apply.

DOOR REVEALS:

-1/16” reveals at top, bottom, & both sides of doors creating a 1/8” reveal between multiple fronts.

ADJUSTABLE SHELVES:

-The number of adjustable shelves is determined by the Configuration (door) height. See chart below.

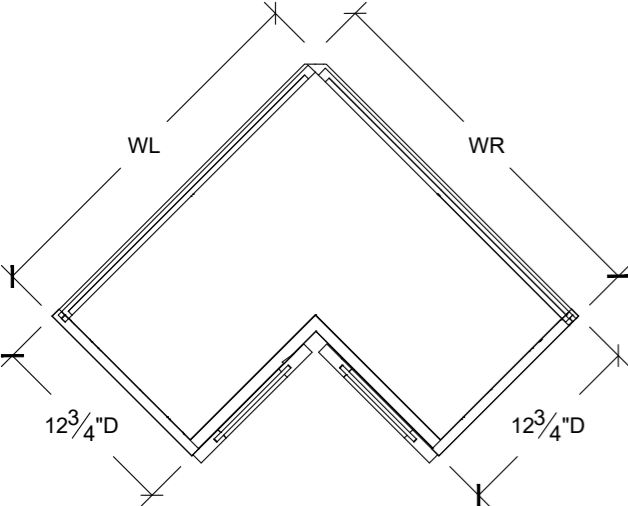

DOOR HEIGHT	ADJUSTABLE SHELF QUANTITY
9”H TO 15”H	0
15 1/8”H TO 27”H	1
27 1/8”H TO 36”H	2
36 1/8”H TO 42”H	3
42 1/8”H TO 54”H	4

BASE CABINETS

BW-H-D BASE CABINET:

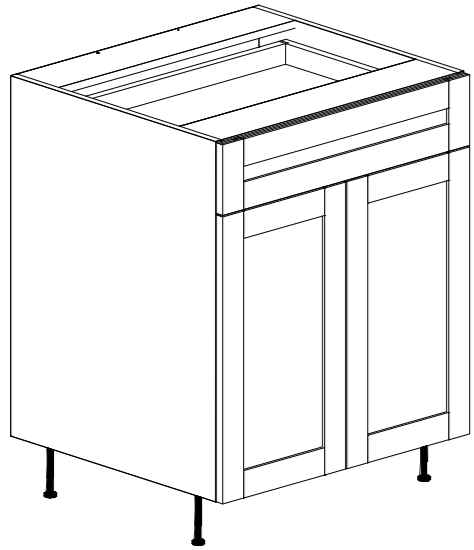

SPECIFICATIONS:

DESCRIPTION:

- 1 - 6"H Full Width Drawer with Door(s) below.
- 1 - Adjustable Shelf.

WIDTHS:

- 9"W to 42"W.
- Cabinets 24"W to 42"W will have 2 doors hinged Left & Right. For full width doors, select L or R hinging. Doors over 24"W will void warranty.
- 36"W+ cabinets will have shelf clips in the centre back of cabinet to support the shelf.
- Minimum Width with Dovetail Drawers: 11 1/2"W.
- See individual Door Style pages for Door limitations.

HEIGHTS:

- 34 1/2"H.
- If cabinet height is modified, drawer will remain 6"H.
- Doors smaller than 12"H (nominal) cannot be hinged.
- Drawer height cannot be reduced.

DEPTHS:

- 23 3/4"D (24).
- Minimum Depth: 12 3/4"D.

DOOR REVEALS:

- 1/16" reveals at top, bottom, & both sides of doors creating a 1/8" reveal between multiple fronts.

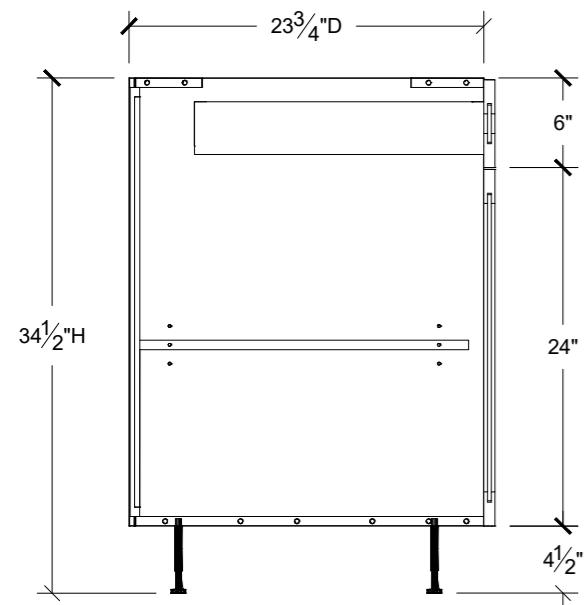

BSW-H-D BASE SPLIT DRAWER CABINET:

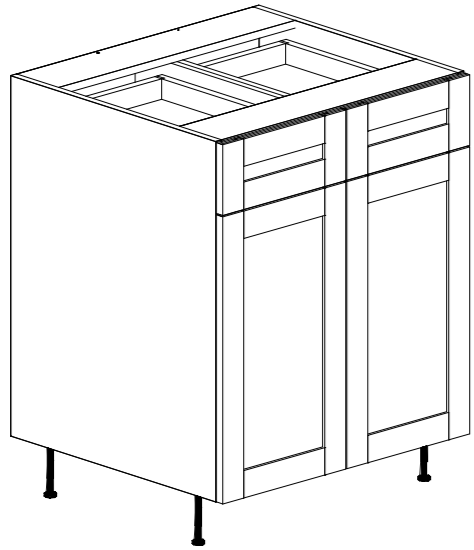

SPECIFICATIONS:

DESCRIPTION:

- 2 - 6"H Drawers with Doors below.
- 1 - Adjustable Shelf.

WIDTHS:

- 24"W to 42"W.
- 36"W+ cabinets will have shelf clips in the centre back of cabinet to support the shelf.

HEIGHTS:

- 34 1/2"H.
- If cabinet height is modified, drawers will remain 6"H.
- Doors smaller than 12"H (nominal) cannot be hinged.
- Drawer height cannot be reduced.

DEPTHS:

- 23 3/4"D (24).
- Minimum Depth: 12 3/4"D.

DOOR REVEALS:

- 1/16" reveals at top, bottom, & both sides of doors creating a 1/8" reveal between multiple fronts.

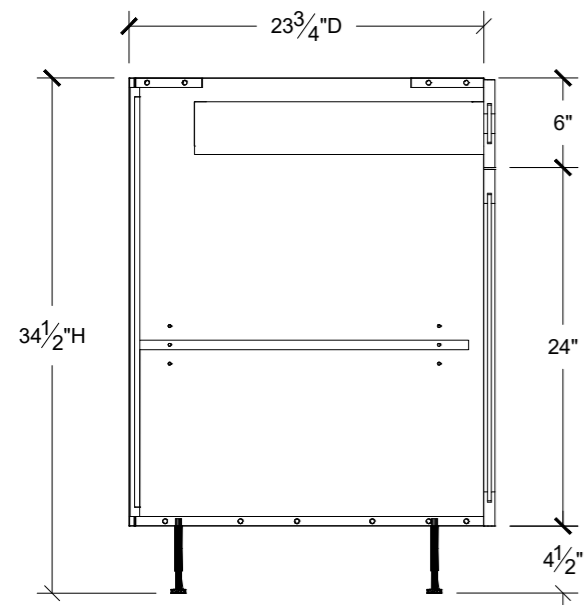

FDBW-H-D FULL HEIGHT DOOR BASE CABINET:

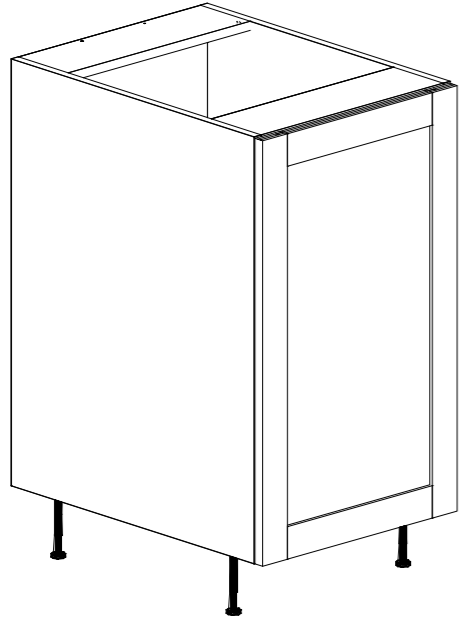

SPECIFICATIONS:

DESCRIPTION:

- Full Height Door cabinet.
- 1 - Adjustable Shelf.

WIDTHS:

- 9"W to 42"W.
- Cabinets 24"W to 42"W will have 2 doors hinged Left & Right. For full width doors, select L or R hinging. Doors over 24"W will void warranty.
- 36"W+ cabinets will have shelf clips in the centre back of cabinet to support the shelf.
- Minimum Width: 6 1/2"W - See individual Door Style pages for Door limitations.

HEIGHTS:

- 34 1/2"H.
- Doors smaller than 12"H (nominal) cannot be hinged.

DEPTHS:

- 23 3/4"D (24).
- Minimum Depth: 4"D.

DOOR REVEALS:

- 1/16" reveals at top, bottom, & both sides of doors creating a 1/8" reveal between multiple fronts.

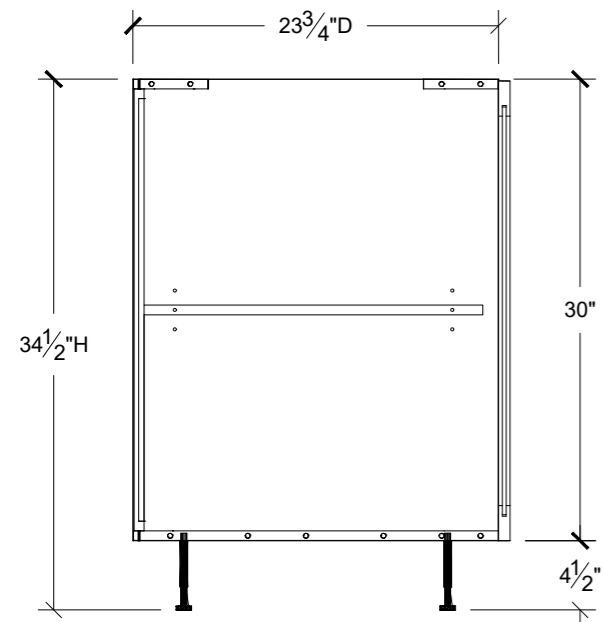

SBW-H-D SINK BASE CABINET:

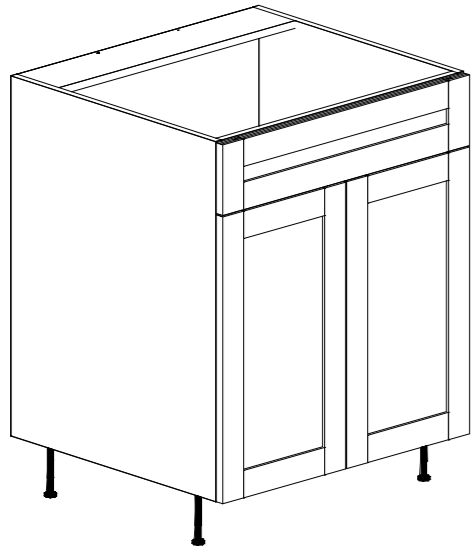

SPECIFICATIONS:

DESCRIPTION:

- 1 - 6"H Full Width False Drawer with Door(s) below.
- No Adjustable Shelf.

WIDTHS:

- 9"W to 42"W.
- Cabinets 24"W to 42"W will have 2 doors hinged Left & Right. For full width doors, select L or R hinging. Doors over 24"W will void warranty.
- See individual Door Style pages for Door limitations.

HEIGHTS:

- 34 1/2"H.
- If cabinet height is modified, drawer front will remain 6"H.
- Doors smaller than 12"H (nominal) cannot be hinged.

DEPTHS:

- 23 3/4"D (24).
- Minimum Depth: 4"D.

DOOR REVEALS:

- 1/16" reveals at top, bottom, & both sides of doors creating a 1/8" reveal between multiple fronts.

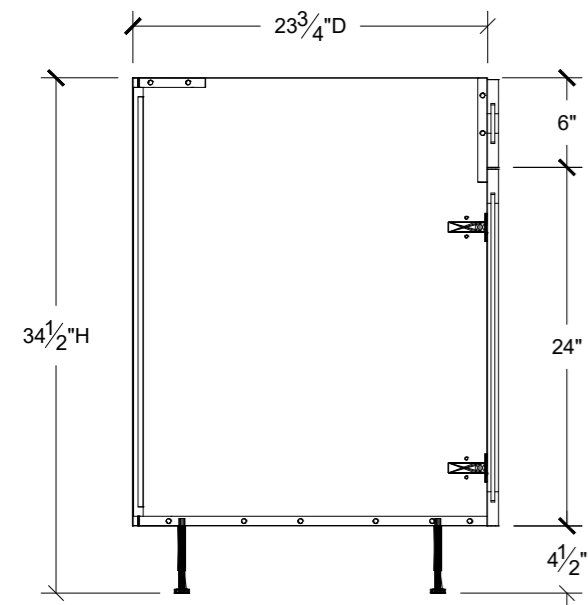

SBW-H-DFS FARMER SINK BASE CABINET:

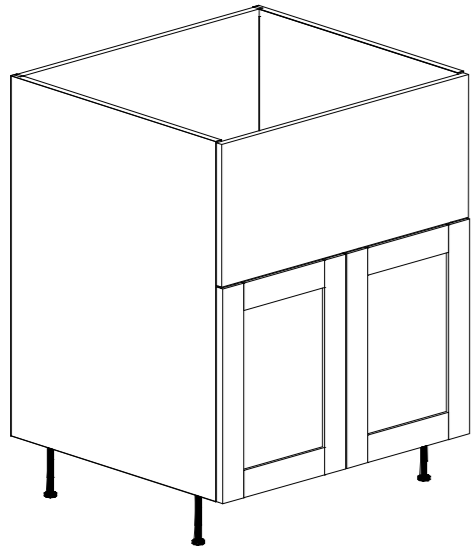

SPECIFICATIONS:

DESCRIPTION:

- 12"H Panel is shipped loose to be cut on-site for Farmer's/Apron Sink.
- No Adjustable Shelf.
- Sink area is unfinished.

WIDTHS:

- 24"W to 42"W.
- For full width doors, select L or R hinging. Doors over 24"W will void warranty.

HEIGHTS:

- 34 1/2"H.
- If cabinet height is modified, drawer front will remain 12"H.
- Doors smaller than 12"H (nominal) cannot be hinged.

DEPTHS:

- 23 3/4"D (24).
- Minimum Depth: 4"D.

DOOR/CONFIGURATION HEIGHTS:

- Listed configuration height is nominal & doesn't take into account door reveals.
- Door/Configuration Heights can be modified, a MODIFY DOORH CONFIG charge will apply.

DOOR REVEALS:

- 1/16" reveals at top, bottom, & both sides of doors creating a 1/8" reveal between multiple fronts.

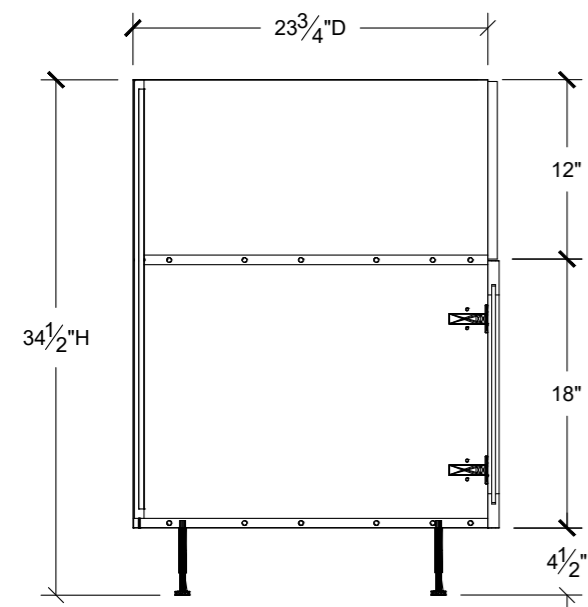

FDSBW-H-D FULL HEIGHT DOOR SINK BASE CABINET:

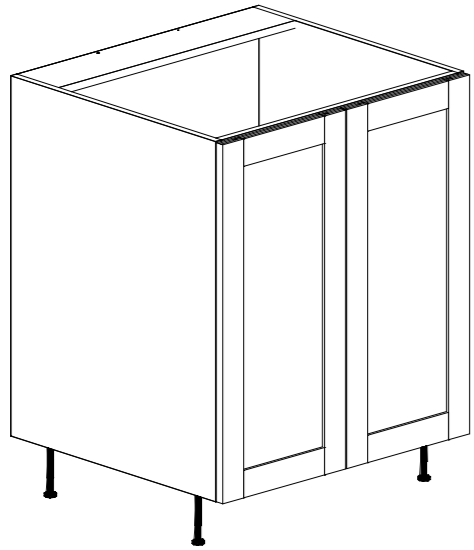

SPECIFICATIONS:

DESCRIPTION:

- Full Height Door cabinet.
- No Adjustable Shelf.

WIDTHS:

- 9"W to 42"W.
- Cabinets 24"W to 42"W will have 2 doors hinged Left & Right. For full width doors, select L or R hinging. Doors over 24"W will void warranty.
- Minimum Width: 6 1/2"W - See individual Door Style pages for Door limitations.

HEIGHTS:

- 34 1/2"H.
- Doors smaller than 12"H (nominal) cannot be hinged.

DEPTHS:

- 23 3/4"D (24).
- Minimum Depth: 4"D.

DOOR REVEALS:

- 1/16" reveals at top, bottom, & both sides of doors creating a 1/8" reveal between multiple fronts.

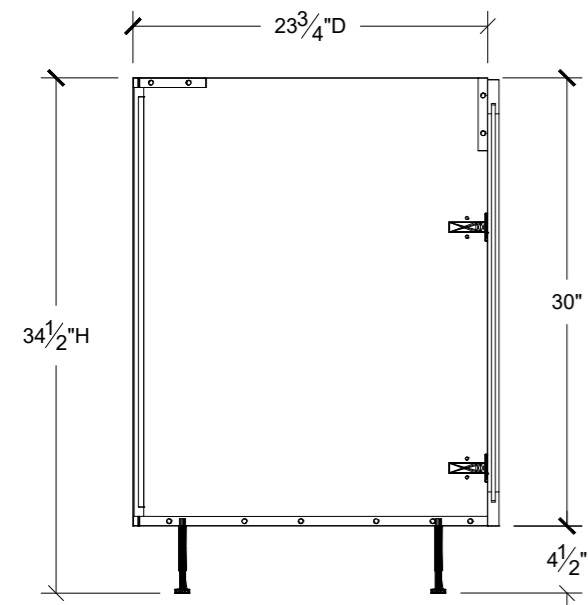

BW-H-D WASTE BASE CABINET WITH WASTE BIN PULL-OUT:



SPECIFICATIONS:

DESCRIPTION:

- Drawer & Door cabinet with Vauth Sagel Envi Space XX Pro Waste Bin system attached to the back of the door.

FEATURES:

- Pull-Out fully extends from cabinet allowing waste bins to be removed without interfering with the countertop.
- Pull-Out glides are soft-close.
- Waste bins come with handles for easy removal.
- Integral metal lid.

WIDTHS:

- 15"W, 18"W, 21"W, & 24"W.
- Due to hardware limitations, no width variations are available.

HEIGHTS:

- 34 1/2"H.
- Minimum door height: 24"H.

DEPTHS:

- 23 3/4"D (24).
- Minimum Depth: 21 1/2"D.

DOOR REVEALS:

- 1/16" reveals at top, bottom, & both sides of doors creating a 1/8" reveal between multiple fronts.

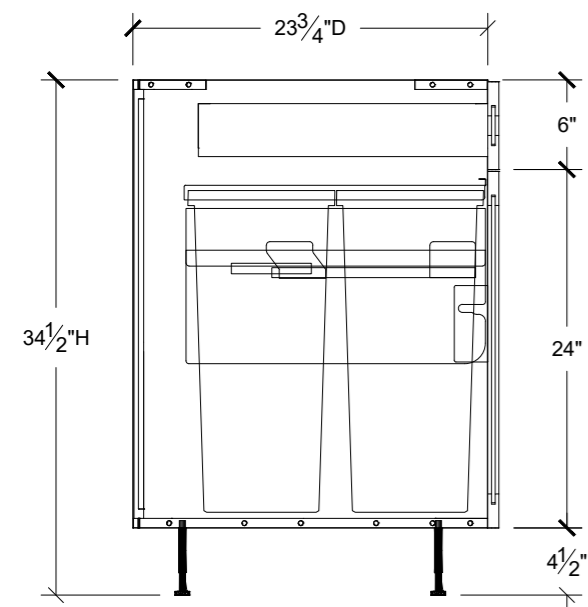

CABINET WIDTH	WASTE BINS
15"W	1 - 35L & 1 - 1.2L
18"W	2 - 35L
21"W	2 - 35L
24"W	2 - 35L & 1 - 21L

FDBW-H-D WASTE

BASE FULL HEIGHT DOOR CABINET WITH WASTE BIN PULL-OUT:



SPECIFICATIONS:

DESCRIPTION:

- Full Height Door cabinet with Vauth Sagel Envi Space XX Pro Waste Bin system attached to the back of the door.

FEATURES:

- Pull-Out fully extends from cabinet allowing waste bins to be removed without interfering with the countertop.
- Pull-Out glides are soft-close.
- Waste bins come with handles for easy removal.
- Integral metal lid doubles as shelf.

WIDTHS:

- 15"W, 18"W, 21"W, & 24"W.
- Due to hardware limitations, no width variations are available.

HEIGHTS:

- 34 1/2"H.
- Minimum door height: 24 1/2"H.

DEPTHS:

- 23 3/4"D (24).
- Minimum Depth: 21 1/2"D.

DOOR REVEALS:

- 1/16" reveals at top, bottom, & both sides of doors creating a 1/8" reveal between multiple fronts.

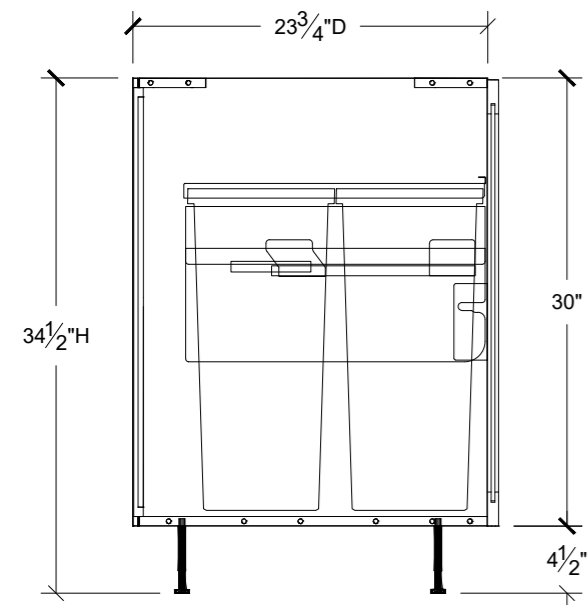

CABINET WIDTH	WASTE BINS
15"W	1 - 35L & 1 - 1.2L
18"W	2 - 35L
21"W	2 - 35L
24"W	2 - 35L & 1 - 21L

BW-H-DWASTEDR BASE CABINET WITH WASTE BIN DRAWER:



SPECIFICATIONS:

DESCRIPTION:

-Drawer & Door cabinet with Dovetail Waste Bin Drawer.

FEATURES:

-Waste Bin Drawer glides are Movento Blumotion Soft-Close.

WIDTHS:

-15"W to 21"W.

-Minimum Width: 13 1/2"W.

HEIGHTS:

-34 1/2"H.

-Minimum door height: 22 1/2"H.

DEPTHS:

-23 3/4"D (24).

-Minimum Depth: 23"D.

DOOR REVEALS:

-1/16" reveals at top, bottom, & both sides of doors creating a 1/8" reveal between multiple fronts.

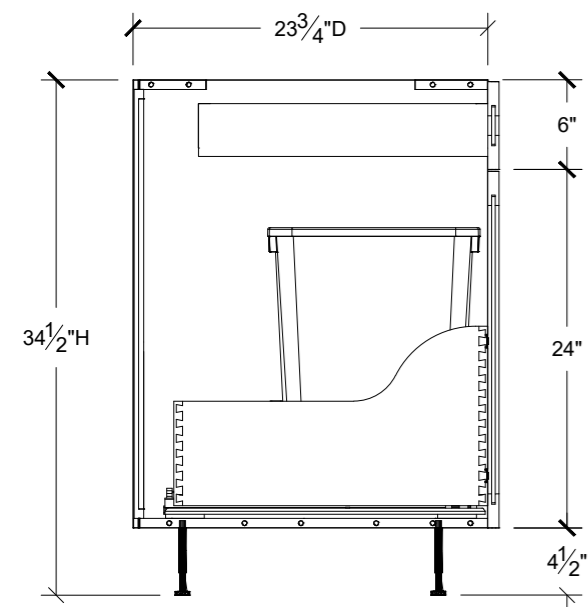

CABINET WIDTH	WASTE BINS
15"W	1 - 33L with Storage behind bin.
18"W	2 - 33L
21"W	2 - 33L

FDBW-H-D WASTEDR

BASE FULL HEIGHT DOOR CABINET WITH WASTE BIN PULL-OUT:



SPECIFICATIONS:

DESCRIPTION:

- Full Height Door cabinet with Dovetail Waste Bin Drawer.

FEATURES:

- Waste Bin Drawer glides are Movento Blumotion Soft-Close.

WIDTHS:

- 15"W to 21"W.

- Minimum Width: 13 1/2"W.

HEIGHTS:

- 34 1/2"H.

- Minimum door height: 22 1/2"H.

DEPTHS:

- 23 3/4"D (24).

- Minimum Depth: 23"D.

DOOR REVEALS:

- 1/16" reveals at top, bottom, & both sides of doors creating a 1/8" reveal between multiple fronts.

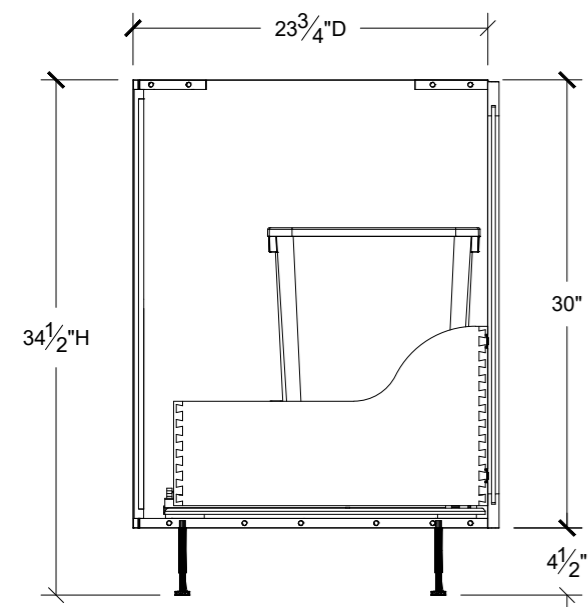

CABINET WIDTH	WASTE BINS
15"W	1 - 35L & 1 - 1.2L
18"W	2 - 35L
21"W	2 - 35L
24"W	2 - 35L & 1 - 21L

FDBW-H-DSS BASE FULL HEIGHT DOOR CABINET WITH VAUTH SAGEL SUB SIDE PULL-OUT:



SPECIFICATIONS:

DESCRIPTION:

- Full Height Door cabinet with Vauth Sagel Sub Side Pull-Out attached to the back of the door.
- Includes 3 baskets.

FEATURES:

- Baskets are available in 2 different finishes: White & Chrome (SSW) & Maple & Chrome (SSM).
- Full extension soft-close glides.
- Baskets are adjustable & removeable.
- Weight capacity: 40 lbs.
- White & Maple finish shelves have an anti-slip coating.

WIDTHS:

- 6"W to 12"W.
- See individual Door Style pages for Door limitations.

HEIGHTS:

- 34 1/2"H.
- Minimum door height: 27"H for hardware but clearance for top shelf items should be taken into consideration.

DEPTHS:

- 23 3/4"D (24).
- Minimum Depth: 20 1/2"D.

DOOR REVEALS:

- 1/16" reveals at top, bottom, & both sides of doors creating a 1/8" reveal between multiple fronts.

NOTES:

- Specify if Pull-Out is to be mounted on the Left or Right Side.

CABINET WIDTH	BASKET WIDTH
6"W to 7 1/2"W	3 1/2"W
8"W to 11"W	5 1/2"W
11 1/2"W to 12"W	8 5/8"W

FDBW-H-DPO BASE FULL HEIGHT DOOR CABINET WITH WOOD PULL-OUT:



SPECIFICATIONS:

DESCRIPTION:

- Full Height Door cabinet with Wood Pull-Out.

FEATURES:

- 3 - Middle shelves are adjustable/removeable.
- Each shelf has chrome-finished railings.
- Pull-Out glides are soft-close.

WIDTHS:

- 9"W to 15"W.
- See individual Door Style pages for Door limitations.

HEIGHTS:

- 34 1/2"H.
- Minimum door height: 27 1/4"H for hardware but clearance for top shelf items should be taken into consideration.

DEPTHS:

- 23 3/4"D (24).
- Minimum Depth: 22 7/8"D.

DOOR REVEALS:

- 1/16" reveals at top, bottom, & both sides of doors creating a 1/8" reveal between multiple fronts.

NOTES:

- Specify if Pull-Out is to be mounted on the Left or Right Side.

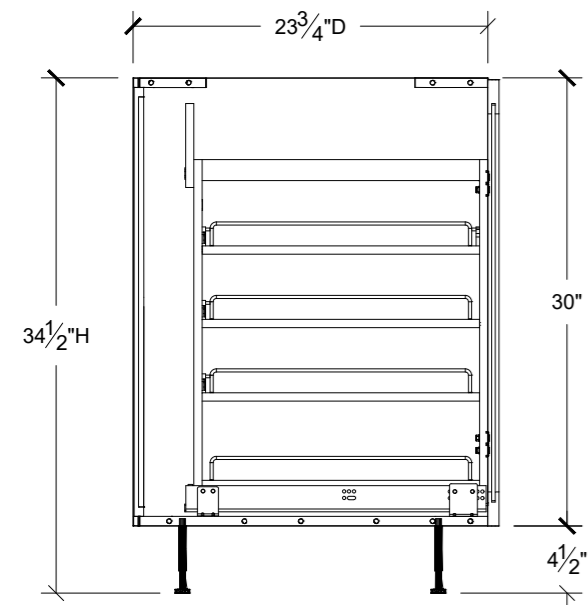

FDBW-H-DTDPO BASE FULL HEIGHT DOOR CABINET WITH TRAY DIVIDER PULL-OUT:



SPECIFICATIONS:

DESCRIPTION:

- Full Height Door cabinet with a Tray Divider Pull-Out attached to the back of the door.

FEATURES:

- Natural maple construction.
- Full-extension BLUMOTION soft-close glides.
- 135 lb. weight capacity.

WIDTHS:

- 7 1/2"W to 9"W & 10 1/2"W to 11"W.
- Due to hardware limitations, only select sizes are available.

HEIGHTS:

- 34 1/2"H.
- Minimum door height: 21 1/4"H for hardware but tray & pan sizes should be taken into consideration.

DEPTHS:

- 23 3/4"D (24).
- Minimum Depth: 22 3/4"D.

DOOR REVEALS:

- 1/16" reveals at top, bottom, & both sides of doors creating a 1/8" reveal between multiple fronts.

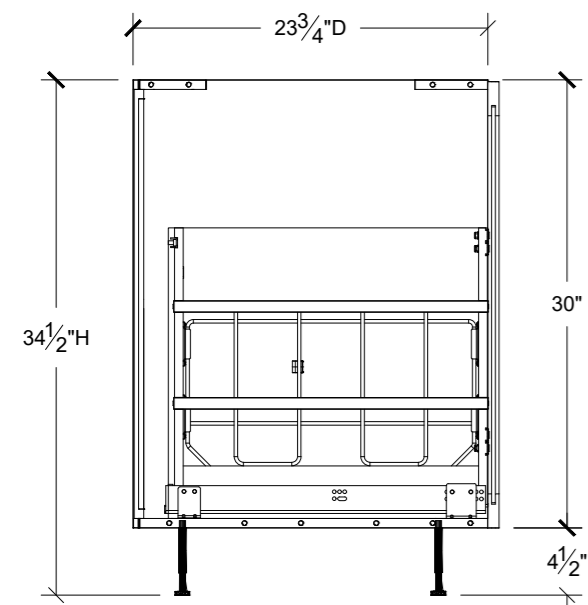

90FDBCWL-WR-H-D 90° CORNER FULL HEIGHT DOOR BASE CABINET:

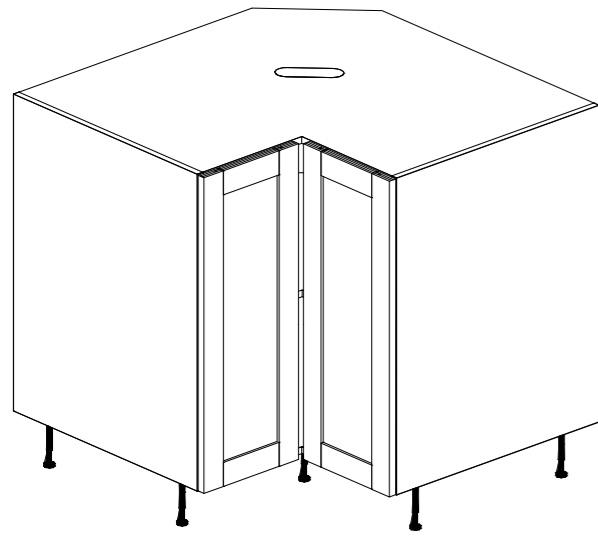

SPECIFICATIONS:

DESCRIPTION:

- Full Height Bi-fold Door cabinet.
- 1 - Adjustable Shelf.

WIDTHS:

- 33"W to 39"W.
- Larger widths will void warranty on the hinges as doors will be prone to sagging.

HEIGHTS:

- 34 1/2"H.
- Doors smaller than 12"H (nominal) cannot be hinged.

DEPTHS:

- 23 3/4"D (24).
- Minimum Depth: Width - 15 1/4". Smaller depths will void warranty on the hinges as doors will be prone to sagging.

DOOR REVEALS:

- 1/16" reveals at top, bottom, & both sides of doors creating a 1/8" reveal between multiple fronts.

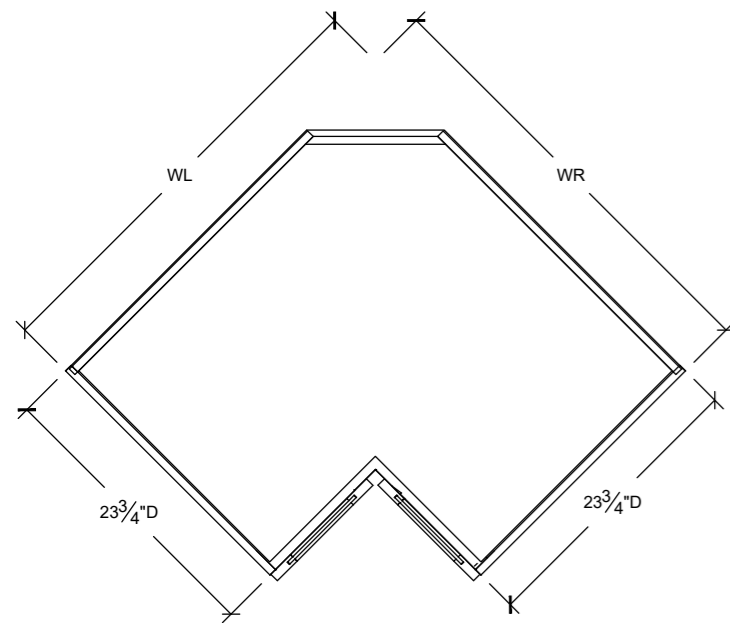

90FDBCLS_{WL-WR-H-D} 90° CORNER FULL HEIGHT DOOR BASE CABINET WITH WOOD LAZY SUSANS:

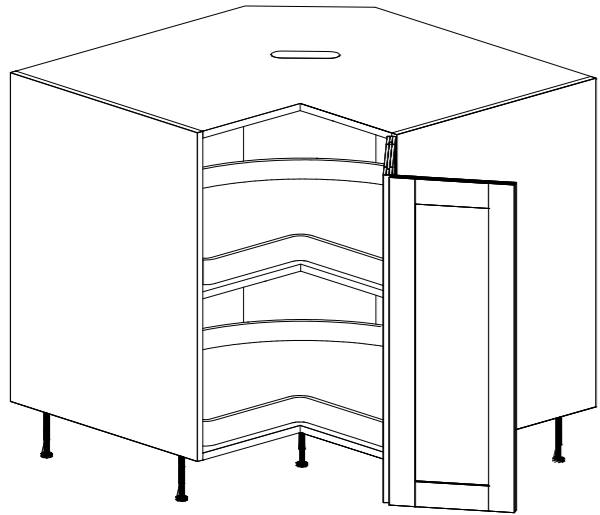

SPECIFICATIONS:

DESCRIPTION:
 - Full Height Bi-fold Door Cabinet with Wood Lazy Susans installed on Floor & Adjustable Shelf.

FEATURES:
 - Susans spin individually on bearings (no pole).
 - Susans are constructed with clear coated maple - both solid & plywood veneer.

WIDTHS:
 - 33"W to 36"W.
 - Larger widths are available but will not increase Lazy Susan size.

HEIGHTS:
 - 34 1/2"H.
 - Minimum: 28 1/2"H.

DEPTHS:
 - 23 3/4"D (24) only.

DOOR REVEALS:
 - 1/16" reveals at top, bottom, & both sides of doors creating a 1/8" reveal between multiple fronts.

CABINET WIDTH	SUSAN SIZE
33"W to 35 1/2"W	28"
36"W	32"

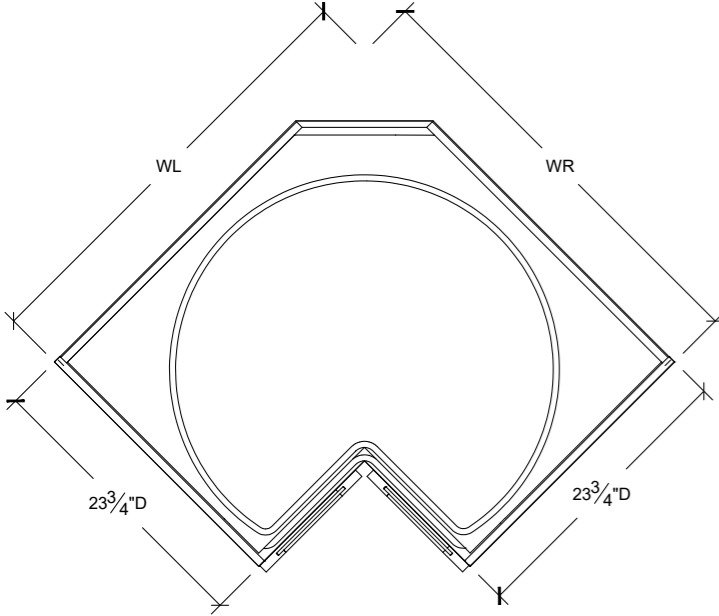



FINISHED COMPONENTS

FILLERS

FLAT FILLER:



FILLER SPECIFICATIONS:

CONSTRUCTION:

- Material core & Thickness will match cabinet construction (Laminates & P.E.T. excluded).
- Finished on the Face.

WIDTHS:

- 6"W.
- Width can be reduced at no upcharge. Minimum width: 1 1/2"W.
- For largers widths, order a panel.

HEIGHTS:

- Heights will vary by SKU.
- Height can be reduced at no upcharge.
- Minimum height: 6"H.

GRAIN DIRECTION:

- Vertical.
- For Slab Door Styles (Mode, Urban, etc.), Grain Direction will match Door Style.

NOTES:

- To add Finished Edges, a modification charge will apply.

SPECIES AVAILABLE:

- Alder, Clear [ALDC]
- Alder, Knotty [ALDK]
- Cherry [CH]
- Laminate [LAM]
- Maple [MA]
- Oak, Red Flat [OAK]
- Oak, White Flat [OAKWF]
- Oak, White Rift [OAKWR]
- P.E.T. (18mm Th) [PET]
- Walnut [WA]

SKU'S:



WF-SPECIES-6XH

DESCRIPTION:

- Wall Flat Filler.
- Finished on Short Edges only.

HEIGHTS:

- 18"H to 60"H.
- For largers heights, order a TF.



BF-SPECIES-6X30

DESCRIPTION:

- Base Flat Filler.

HEIGHTS:

- 30"H.
- Height can be reduced at no upcharge. Minimum height: 6"H.
- For largers heights, order a WF.



TF-SPECIES-6X96

DESCRIPTION:

- Tall Flat Filler.

HEIGHTS:

- 96"H.



VF-SPECIES-6X27

DESCRIPTION:

- Vanity Flat Filler.

HEIGHTS:

- 27"H.
- Height can be reduced at no upcharge. Minimum height: 6"H.
- For largers heights, order a BF.

SOLID STOCK FILLER:

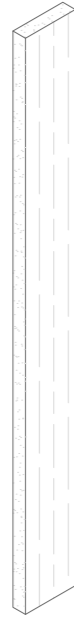

FILLER SPECIFICATIONS:

CONSTRUCTION:

- Solid Wood or MDF.
- Finished on the Face & all Edges.

WIDTHS:

- 3"W & 6"W.
- Width can be reduced at no upcharge.
- Minimum width: 1 1/2"W.

HEIGHTS:

- Heights will vary by SKU.
- Height can be reduced at no upcharge.
- Minimum height: 6"H.

GRAIN DIRECTION:

- Vertical.
- For Slab Door Styles (Mode, Urban, etc.), Grain Direction will match Door Style.

SPECIES AVAILABLE:

- Alder, Clear [ALDC]
- Alder, Knotty [ALDK]
- Cherry [CH]
- Maple [MA]
- MDF [MDF]
- Oak, Red Flat [OAK]
- Oak, White Flat [OAKWF]
- Oak, White Rift [OAKWR]
- Walnut [WA]

SKU'S:



DESCRIPTION:

- Wall Solid Stock Filler.

HEIGHTS:

- 18"H to 60"H.
- For largers heights, order a TSSF.

WSSF-SPECIES-WXH



DESCRIPTION:

- Base Solid Stock Filler.

HEIGHTS:

- 30"H.
- Height can be reduced at no upcharge. Minimum height: 6"H.
- For largers heights, order a WSSF.

BSSF-SPECIES-WX30



DESCRIPTION:

- Tall Solid Stock Filler.

HEIGHTS:

- 84"H to 96"H.

TSSF-SPECIES-WXH



DESCRIPTION:

- Vanity Solid Stock Filler.

HEIGHTS:

- 27"H.
- Height can be reduced at no upcharge. Minimum height: 6"H.
- For largers heights, order a BSSF.

VSSF-SPECIES-WX27

OVERLAY FILLER:



FILLER SPECIFICATIONS:

CONSTRUCTION:

- Solid Wood or MDF.
- Outside Profile on all 4 Edges matches Door Style listed in Header.
- Finished on the Face & all 4 Edges.

WIDTHS:

- 2 7/8"W (3) & 5 7/8"W (6).
- Width can be reduced at no upcharge.
- Minimum width: 2 1/2"W.

HEIGHTS:

- Heights will vary by SKU. Heights listed are nominal. Fillers will be manufactured to line up with standard Door Sizes.
- Height can be reduced at no upcharge.
- Minimum height: 6"H.

GRAIN DIRECTION:

- Vertical.

DOOR STYLE AVAILABILITY:

- For Laminate, P.E.T., or Wood Veneer (Urban) doors, order a Overlay Veneer Filler.

SPECIES AVAILABLE:

- Alder, Clear [ALDC]
- Alder, Knotty [ALDK]
- Cherry [CH]
- Maple [MA]
- MDF [MDF]
- Oak, Red Flat [OAK]
- Oak, White Flat [OAKWF]
- Oak, White Rift [OAKWR]
- Walnut [WA]

PROFILE:

TOP VIEW

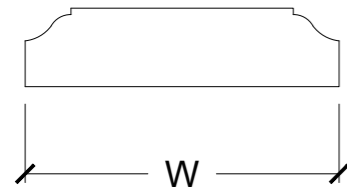

SKU'S:



DESCRIPTION:

- Wall Overlay Filler.

HEIGHTS:

- 17 7/8"H (18) to 59 7/8"H (60).
- For largers heights, order a TOF.

WOF-SPECIES-WXH



DESCRIPTION:

- Base Overlay Filler.

HEIGHTS:

- 29 7/8"H (30).
- For largers heights, order a WOF.

BOF-SPECIES-WX30



DESCRIPTION:

- Tall Overlay Filler.

HEIGHTS:

- 79 3/8"H (84) & 91 3/8"H (96).

TOF-SPECIES-WXH



DESCRIPTION:

- Vanity Overlay Filler.

HEIGHTS:

- 26 7/8"H (27).
- For largers heights, order a BOF.

VOF-SPECIES-WX27

OVERLAY VENEER FILLER:



FILLER SPECIFICATIONS:

CONSTRUCTION:

- Material core & Thickness will match door construction (Laminates & P.E.T. excluded).
- Finished on the Face & all 4 Edges.

WIDTHS:

- 5 7/8"W (6).
- Width can be reduced at no upcharge. Minimum width: 3"W.

HEIGHTS:

- Heights will vary by SKU. Heights listed are nominal. Fillers will be manufactured to line up with standard Door Sizes.
- Height can be reduced at no upcharge.
- Minimum height: 6"H.
- Horizontal Grain Maximum Height: 48"H.

GRAIN DIRECTION:

- Grain Direction will match Door Style.

DOOR STYLE AVAILABILITY:

- For Melamine, P.E.T. & Urban Door Styles only.

SPECIES AVAILABLE:

- Alder, Clear [ALDC]
- Alder, Knotty [ALDK]
- Cherry [CH]
- Laminate [LAM]
- Maple [MA]
- Oak, Red Flat [OAK]
- Oak, White Flat [OAKWF]
- Oak, White Rift [OAKWR]
- Paint Grade
- P.E.T. [PET]
- Walnut [WA]

PROFILE:

TOP VIEW

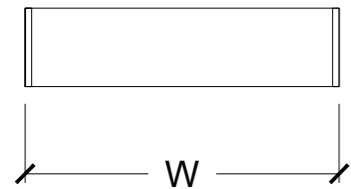

SKU'S:



WOVF-SPECIES-6XH

DESCRIPTION:

- Wall Overlay Veneer Filler.

HEIGHTS:

- 17 7/8"H (18) to 59 7/8"H (60).
- For largers heights, order a TOVF.



BOVF-SPECIES-6X30

DESCRIPTION:

- Base Overlay Veneer Filler.

HEIGHTS:

- 29 7/8"H (30).
- For largers heights, order a WOVF.



TOVF-SPECIES-6XH

DESCRIPTION:

- Tall Overlay Veneer Filler.

HEIGHTS:

- 79 3/8"H (84) & 91 3/8"H (96).



VOVF-SPECIES-6X27

DESCRIPTION:

- Vanity Overlay Veneer Filler.

HEIGHTS:

- 26 7/8"H (27).
- For largers heights, order a BOVF.

DOOR MATCH FILLER:

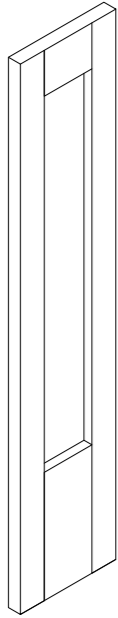

FILLER SPECIFICATIONS:

CONSTRUCTION:

- Construction matches Door Style.
- Outside Profile will be square.
- Finished on the Face & all 4 Edges.
- Centre panel will always be Flat/Recessed.

WIDTHS:

- Up to 6"W.
- Minimum width will vary by Door Style. Please refer to individual Door Style spec page.

HEIGHTS:

- Heights will vary by SKU. Heights listed are nominal. Fillers will be manufactured to line up with standard Door Sizes.
- Height can be reduced at no upcharge.
- Minimum height: 6"H.

DOOR STYLE AVAILABILITY:

- Please refer to individual Door Style Spec page for availability.

SPECIES AVAILABLE:

- Alder, Clear [ALDC]
- Alder, Knotty [ALDK]
- Cherry [CH]
- Laminate [LAM]
- Maple [MA]
- MDF [MDF]
- Oak, Red Flat [OAK]
- Oak, White Flat [OAKWF]
- Oak, White Rift [OAKWR]
- Walnut [WA]

PROFILE:

TOP VIEW

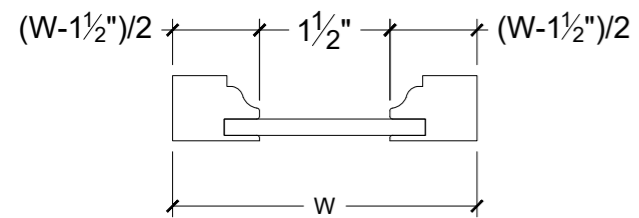

SKU'S:

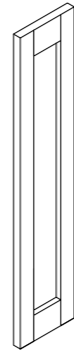

WDMF-6XH

DESCRIPTION:

- Wall Door Match Filler.
- Top & Bottom Rail Widths will match Door Style.

HEIGHTS:

- 18"H to 60"H.
- For largers heights, order a TDMF.



BDMF-6X35

DESCRIPTION:

- Base Door Match Filler.
- Top Rail Widths will match Door Style. Bottom Rail will be increased by 4 1/2" for Toe Kick.

HEIGHTS:

- 34 1/2"H.

NOTES:

- Bottom Rail Width can be decreased at no additional charge.

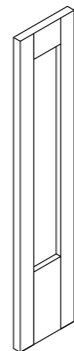

TDMF-6XH

DESCRIPTION:

- Tall Door Match Filler.
- Top Rail Widths will match Door Style. Bottom Rail will be increased by 4 1/2" for Toe Kick.

HEIGHTS:

- 84"H to 96"H.

NOTES:

- Bottom Rail Width can be decreased at no additional charge.



VDMF-6X32

DESCRIPTION:

- Vanity Door Match Filler.
- Top Rail Widths will match Door Style. Bottom Rail will be increased by 4 1/2" for Toe Kick.

HEIGHTS:

- 31 1/2"H.

NOTES:

- Bottom Rail Width can be decreased at no additional charge.

CORNER FLAT FILLER:

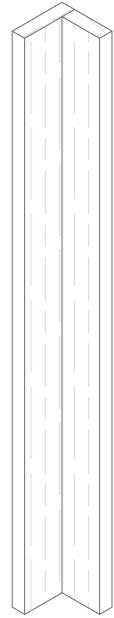

FILLER SPECIFICATIONS:

CONSTRUCTION:

- 2 Flat Fillers joined at 90°.
- Material core & Thickness will match cabinet construction (Laminates & P.E.T. excluded).
- Finished on the Face.

WIDTHS:

- 3"x3" & 6"x6". The width is measured on the inside of the angle. The overall width will vary by material thickness.
- Width can be reduced at no upcharge. Minimum width: 1 1/2"W.

HEIGHTS:

- Heights will vary by SKU.
- Height can be reduced at no upcharge.
- Minimum height: 6"H.

GRAIN DIRECTION:

- Vertical.
- For Slab Door Styles (Mode, Urban, etc.), Grain Direction will match Door Style.

NOTES:

- To add Finished Edges, a modification charge will apply.

SPECIES AVAILABLE:

- Alder, Clear [ALDC]
- Alder, Knotty [ALDK]
- Cherry [CH]
- Laminate [LAM]
- Maple [MA]
- MDF [MDF]
- Oak, Red Flat [OAK]
- Oak, White Flat [OAKWF]
- Oak, White Rift [OAKWR]
- P.E.T. [PET]
- Walnut [WA]

PROFILE:

TOP VIEW

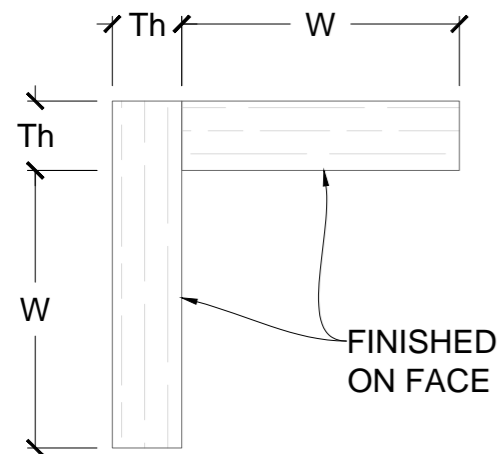

SKU'S:

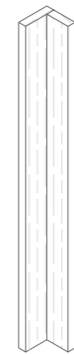

90WF-SPECIES-WXH

DESCRIPTION:

- Wall Corner Flat Filler.
- Finished on both Short Edges.

HEIGHTS:

- 18"H to 60"H.
- For largers heights, order a 90TF.

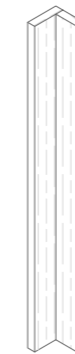

90BF-SPECIES-WX30

DESCRIPTION:

- Base Corner Flat Filler.

HEIGHTS:

- 30"H.
- Height can be reduced at no upcharge. Minimum height: 6"H.
- For largers heights, order a 90WF.

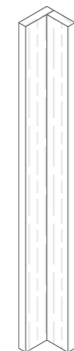

90TF-SPECIES-WXH

DESCRIPTION:

- Tall Corner Flat Filler.

HEIGHTS:

- 84"H to 96"H.

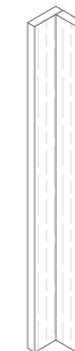

90VF-SPECIES-WX27

DESCRIPTION:

- Vanity Corner Flat Filler.

HEIGHTS:

- 27"H.
- Height can be reduced at no upcharge. Minimum height: 6"H.
- For largers heights, order a 90BF.

CORNER OVERLAY FILLER:

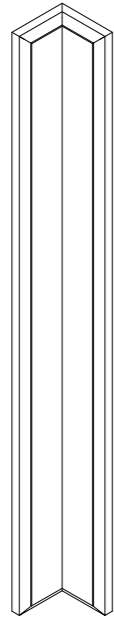

FILLER SPECIFICATIONS:

CONSTRUCTION:

- 2 Overlay Fillers mitered at 90°.
- Outside Profile on all 4 Edges matches Door Style listed in Header.
- Finished on the Face & all 4 Short Edges.

WIDTHS:

- 2 15/16" x 2 15/16" (3) & 5 15/16" x 5 15/16" (6). The width is measured on the outside of the angle.
- Width can be reduced at no upcharge.
- Minimum width: 1 1/2"W.

HEIGHTS:

- Heights will vary by SKU.
- Height can be reduced at no upcharge.
- Minimum height: 6"H.

GRAIN DIRECTION:

- Vertical.

DOOR STYLE AVAILABILITY:

- Not available for Laminate, P.E.T., or Wood Veneer (Urban) doors.

SPECIES AVAILABLE:

- Alder, Clear [ALDC]
- Alder, Knotty [ALDK]
- Cherry [CH]
- Maple [MA]
- Oak, Red Flat [OAK]
- Oak, White Flat [OAKWF]
- Oak, White Rift [OAKWR]
- Paint Grade
- Walnut [WA]

PROFILE:

TOP VIEW

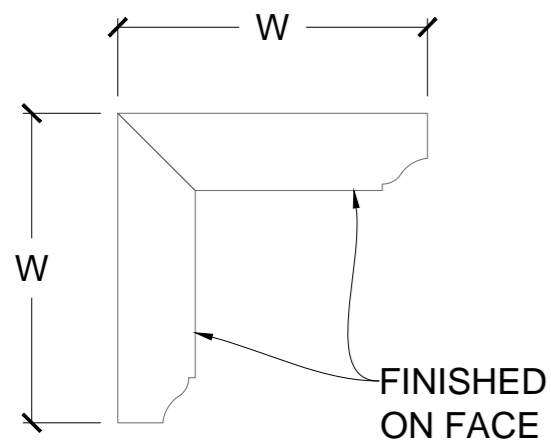

SKU'S:

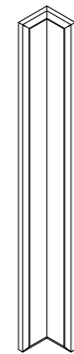

90WOF-SPECIES-WXH

DESCRIPTION:

- Wall Corner Overlay Filler.

HEIGHTS:

- 17 7/8"H (18) to 59 7/8"H (60).
- For largers heights, order a 90TOF.



90BOF-SPECIES-WX30

DESCRIPTION:

- Base Corner Overlay Filler.

HEIGHTS:

- 29 7/8"H (30).
- For largers heights, order a 90WOF.

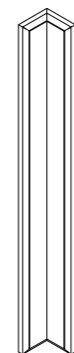

90TOF-SPECIES-WXH

DESCRIPTION:

- Tall Corner Overlay Filler.

HEIGHTS:

- 79 3/8"H (84) & 91 3/8"H (96).



90VOF-SPECIES-WX27

DESCRIPTION:

- Vanity Corner Overlay Filler.

HEIGHTS:

- 26 7/8"H (27).
- For largers heights, order a 90BOF.

PANELS

veneer PANEL:

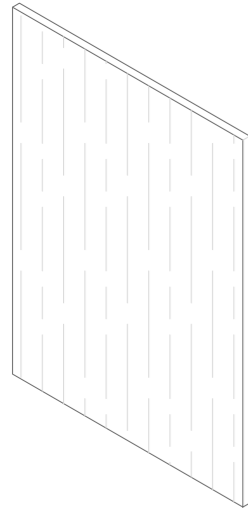

PANEL SPECIFICATIONS:

DESCRIPTION:

- Wood Veneer, Laminate, or P.E.T. panels.
- All Edges will be finished except on Tall Panels over 72"H. Tall Panels will be finished on Vertical Edges only by default. All edges can be finished at no additional charge but must be noted on the line item.

THICKNESS:

- For Wood Veneers, the Thickness will match that of the Interior Finish.
- Laminate & P.E.T., the Thickness will be 3/4"Th.

CORE MATERIAL:

- For Wood Veneers, core will match that of the Interior Finish.

- Laminate & P.E.T. cores will be either MDF or Particle Core depending on the finish.

MAXIMUM SIZE:

- 48"W x 120"H or 120"W x 48"H.
- Panels larger than the available size (see Species spec page), will have biscuit joint & visible seam. Cross-grain Panels will be ordered when possible to avoid seam.

GRAIN DIRECTION:

- Vertical.
- For Slab Door Styles (Mode, Urban, etc.), Grain Direction will match Door Style.

SPECIES AVAILABLE:

- Alder, Clear [ALDC]
- Alder, Knotty [ALDK]
- Cherry [CH]
- Laminate [LAM]
- Maple [MA]
- Oak, Red Flat [OAK]
- Oak, White Flat [OAKWF]
- Oak, White Rift [OAKWR]
- P.E.T. (18mm Th) [PET]
- Walnut [WA]

SKU'S:



PN-SPECIES-F1S

DESCRIPTION:

- Finished 1 Side.

NOTES:

- Laminate & P.E.T. not available.



PN-SPECIES-F2S

DESCRIPTION:

- Finished 2 Sides.

PAINTED MDF PANEL:

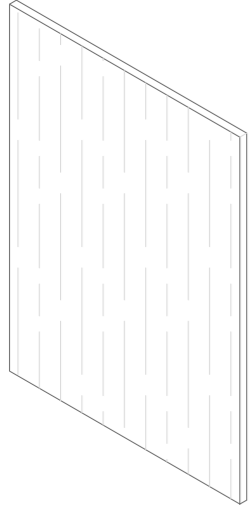

PANEL SPECIFICATIONS:

- DESCRIPTION:
-Painted MDF Panel.
- THICKNESS:
-Available 5/8" & 3/4"Th.
- CORE MATERIAL:
-Solid MDF panel.
- MAXIMUM SIZE:
-48"W x 120"H or 120"W x 48"H.
-Panels larger than the available size (see Species spec page), will have biscuit joint & visible seam.

- FINISHED EDGES:
-All Edges will be finished except on Tall Panels over 72"H. Tall Panels will be finished on Vertical Edges only by default. All edges can be finished at no additional charge but must be noted on the line item.

SPECIES AVAILABLE:

- MDF [MDF]

SKU'S:

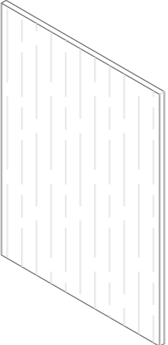

PN-SPECIES-F1S-5/8

- DESCRIPTION:
-Finished 1 Side.

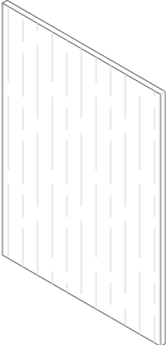

PN-SPECIES-F2S-3/4

- DESCRIPTION:
-Finished 2 Sides.

PILASTERS

GENERAL PILASTER SPECIFICATIONS:

- CONSTRUCTION:
- Top & Bottom Edges will be finished.
 - Outside Faces will be finished.

- SHAPES:
- Pilasters are available in 4 Shapes:

TOP VIEW - JL SHAPE

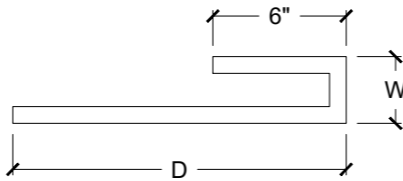

TOP VIEW - JR SHAPE

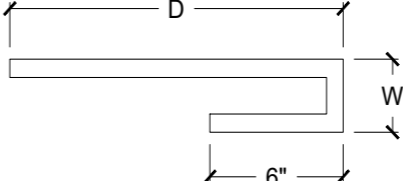

TOP VIEW - LL SHAPE

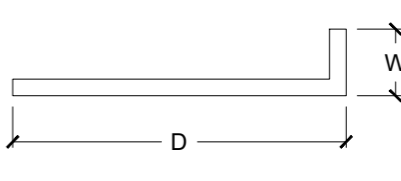

TOP VIEW - LR SHAPE

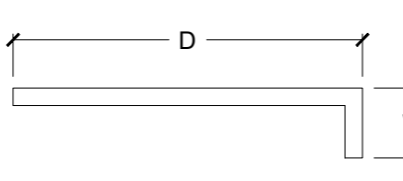

TOP VIEW - O SHAPE

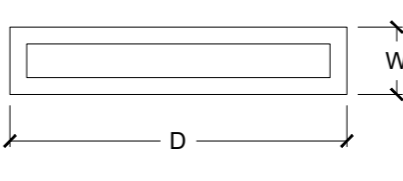

TOP VIEW - U SHAPE

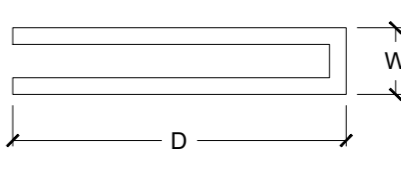

FLAT PILASTER:

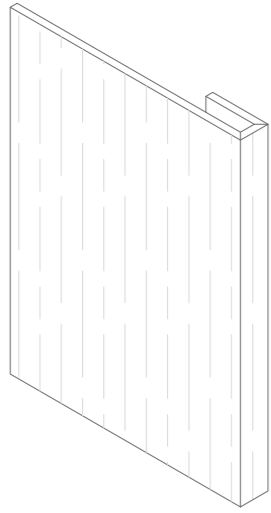

PILASTER SPECIFICATIONS:

CONSTRUCTION:

- 1 1/2"W Pilasters will have a veneered front.
- Wider widths will have mitre joint.

WIDTHS:

- 1 1/2"W to 6"W.
- Widths can be reduced at no-charge.
- Minimum width: 1 1/2"W.

HEIGHTS:

- Heights will vary by SKU.
- Height can be reduced at no upcharge.

DEPTHS:

- 3"D to 48"D.

GRAIN DIRECTION:

- Vertical.
- For Slab Door Styles (Mode, Urban, etc.), Grain Direction will match Door Style.

NOTES:

- To add Finished Edges, a modification charge will apply.

SPECIES AVAILABLE:

- Alder, Clear [ALDC]
- Alder, Knotty [ALDK]
- Cherry [CH]
- Laminate [LAM]
- Maple [MA]
- MDF [MDF]
- Oak, Red Flat [OAK]
- Oak, White Flat [OAKWF]
- Oak, White Rift [OAKWR]
- P.E.T. [PET]
- Walnut [WA]

PROFILE:

TOP VIEW - JL SHAPE

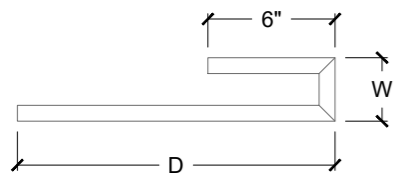

TOP VIEW - LL SHAPE

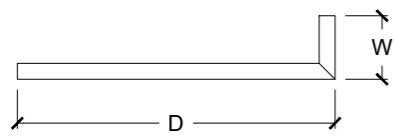

TOP VIEW - O SHAPE

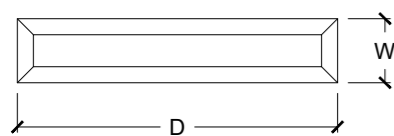

TOP VIEW - U SHAPE

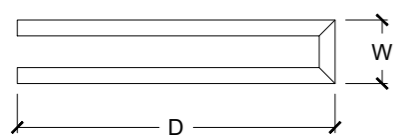

SKU'S:

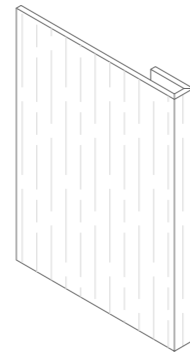

DESCRIPTION:

- Wall Flat Pilaster.
- Finished Top & Bottom Edges.

HEIGHT:

- 18"H to 60"H.
- For larger heights, order a TPIL.

WPIL-SPECIES-WXH-SHAPE

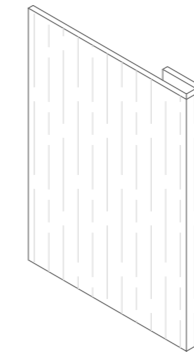

DESCRIPTION:

- Base Flat Pilaster.

HEIGHT:

- 34 1/2"H.

BPIL-SPECIES-WX35-SHAPE

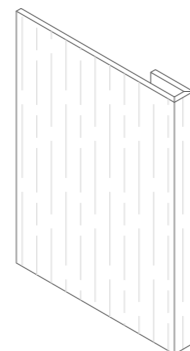

DESCRIPTION:

- Tall Flat Pilaster.

HEIGHT:

- 84"H to 96"H.

TPIL-SPECIES-WXH-SHAPE

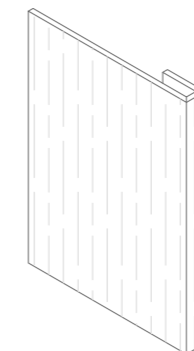

DESCRIPTION:

- Vanity Flat Pilaster.

HEIGHT:

- 31 1/2"H.
- For larger heights, order a BPIL.

VPIL-SPECIES-WX32-SHAPE

FLAT ANGLED 45 PILASTER:

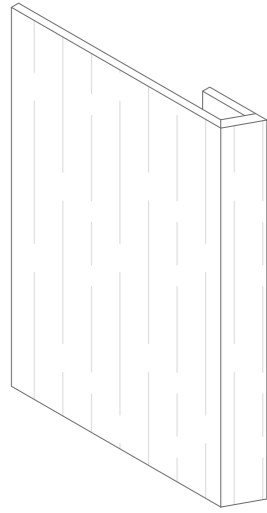

PILASTER SPECIFICATIONS:

CONSTRUCTION:

- Pilasters with true 45° angle. Front Piece is Solid Wood or MDF.
- The 45° angle will have a slightly eased edge to prevent chipping & damage.

WIDTHS:

- 3"W to 6"W.
- Widths can be reduced at no-charge.
- Minimum width: 3"W.

HEIGHTS:

- Heights will vary by SKU.
- Height can be reduced at no upcharge.

DEPTHS:

- 15"D to 48"D.

GRAIN DIRECTION:

- Vertical.
- For Slab Door Styles (Mode, Urban, etc.), Grain Direction will match Door Style.

NOTES:

- To add Finished Edges, a modification charge will apply.

SPECIES AVAILABLE:

- Alder, Clear [ALDC]
- Alder, Knotty [ALDK]
- Cherry [CH]
- Maple [MA]
- MDF [MDF]
- Oak, Red Flat [OAK]
- Oak, White Flat [OAKWF]
- Oak, White Rift [OAKWR]
- Walnut [WA]

PROFILE:

TOP VIEW - JL SHAPE

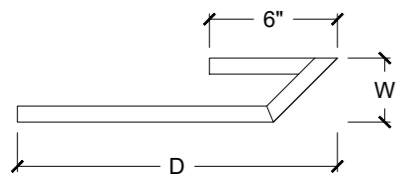

TOP VIEW - O SHAPE

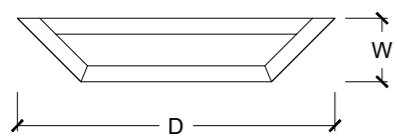

TOP VIEW - U SHAPE

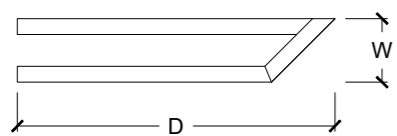

SKU'S:

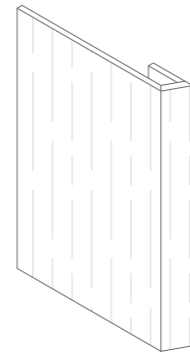

DESCRIPTION:

- Wall Flat Angled Pilaster.

HEIGHT:

- 18"H to 60"H.
- For larger heights, order a TPIL.

WA45PIL-SPECIES-WXH-SHAPE

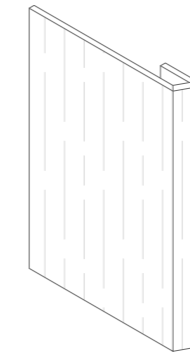

DESCRIPTION:

- Base Flat Angled Pilaster.

HEIGHT:

- 34 1/2"H.

BA45PIL-SPECIES-WX35-SHAPE

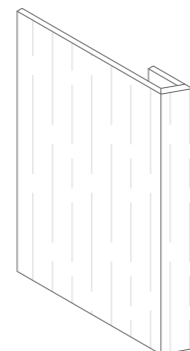

DESCRIPTION:

- Tall Flat Angled Pilaster.

HEIGHT:

- 84"H to 96"H.

TA45PIL-SPECIES-WXH-SHAPE

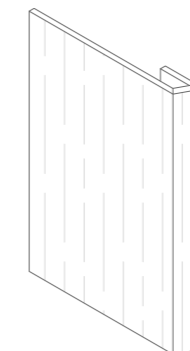

DESCRIPTION:

- Vanity Flat Angled Pilaster.

HEIGHT:

- 31 1/2"H.
- For larger heights, order a BPIL.

VA45PIL-SPECIES-WX32-SHAPE

DOOR MATCH PILASTER:

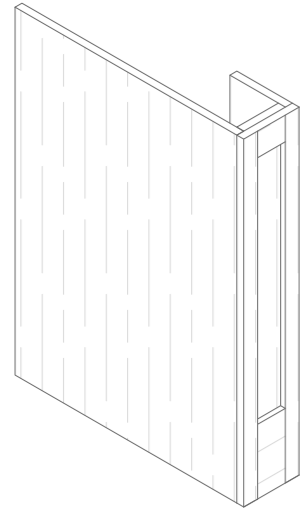

PILASTER SPECIFICATIONS:

CONSTRUCTION:

- A Door Match Filler will be butt-joined to face of Pilaster.

WIDTHS:

- Up to 6"W.
- Minimum width will vary by Door Style. Please refer to individual Door Style spec page.
- Widths can be reduced at no upcharge.

HEIGHTS:

- Heights will vary by SKU.
- Height can be reduced at no upcharge.

DEPTHS:

- 3"D to 48"D.

GRAIN DIRECTION:

- Vertical Side Panels.

DOOR STYLE AVAILABILITY:

- Please refer to individual Door Style Spec page for availability.

NOTES:

- To add Finished Edges, a modification charge will apply.

SPECIES AVAILABLE:

- Alder, Clear [ALDC]
- Alder, Knotty [ALDK]
- Cherry [CH]
- Laminate [LAM]
- Maple [MA]
- MDF [MDF]
- Oak, Red Flat [OAK]
- Oak, White Flat [OAKWF]
- Oak, White Rift [OAKWR]
- Walnut [WA]

PROFILE:

TOP VIEW - JL SHAPE

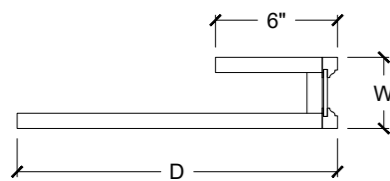

TOP VIEW - LL SHAPE

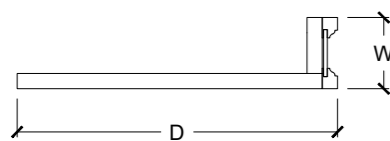

TOP VIEW - O SHAPE

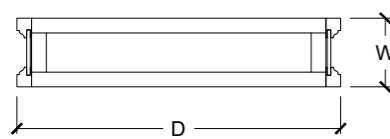

TOP VIEW - U SHAPE



SKU'S:

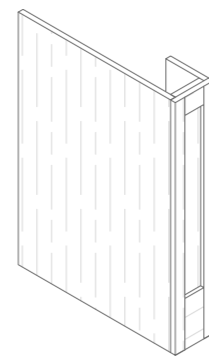

WDMPIL-6XH-SHAPE

DESCRIPTION:

- Wall Door Match Pilaster.
- Top & Bottom Rail Widths will match Door Style.

HEIGHTS:

- 18"H to 60"H.
- For larger heights, order a TDMPIL.

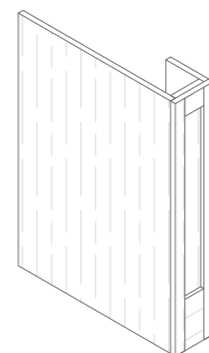

TDMPIL-6XH-SHAPE

DESCRIPTION:

- Tall Door Match Pilaster.
- Top Rail Widths will match Door Style. Bottom Rail will be increased by 4 1/2" for Toe Kick.

HEIGHTS:

- 84"H to 96"H.

NOTES:

- Bottom Rail Width can be decreased at no additional charge.

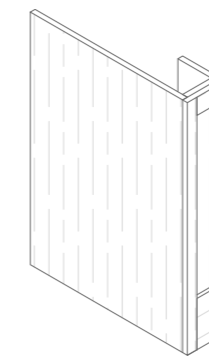

BDMPIL-6X35-SHAPE

DESCRIPTION:

- Base Door Match Pilaster.
- Top Rail Widths will match Door Style. Bottom Rail will be increased by 4 1/2" for Toe Kick.

HEIGHTS:

- 34 1/2"H.

NOTES:

- Bottom Rail Width can be decreased at no additional charge.

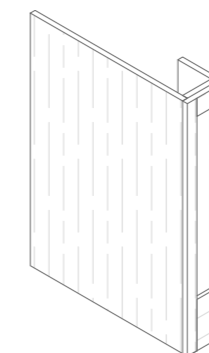

VMPIL-6X32-SHAPE

DESCRIPTION:

- Vanity Door Match Pilaster.
- Top Rail Widths will match Door Style. Bottom Rail will be increased by 4 1/2" for Toe Kick.

HEIGHTS:

- 31 1/2"H.

NOTES:

- Bottom Rail Width can be decreased at no additional charge.

SHELVES

STANDARD SHELF:

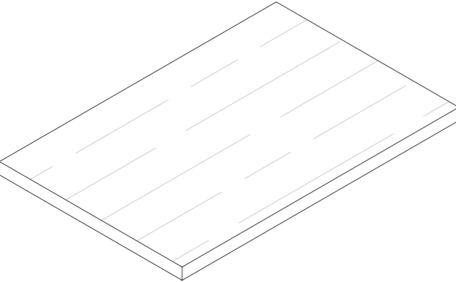

SHELF SPECIFICATIONS:

DESCRIPTION:

- Standard Cabinet Shelf.
- Front Edge will be finished.

THICKNESS:

- The Thickness will match that of the Interior Finish except for Laminate & P.E.T., the Thickness will be 3/4"Th.

MAXIMUM SIZE:

- 42"W x 30"D.

GRAIN DIRECTION:

- Runs along the width of the Shelf.

NOTES:

- Dimensions can be nominal (overall dimensions of Cabinet). If so, please make add Note: "SIZE TO FIT CABINET _____".
- To add additional Finished Edges, a modification charge will apply.

SPECIES AVAILABLE:

- Alder, Clear [ALDC]
- Alder, Knotty [ALDK]
- Cherry [CH]
- Laminate [LAM]
- Maple [MA]
- MDF [MDF]
- Oak, Red Flat [OAK]
- Oak, White Flat [OAKWF]
- Oak, White Rift [OAKWR]
- P.E.T. (18mm Th) [PET]
- Walnut [WA]

SKU'S:

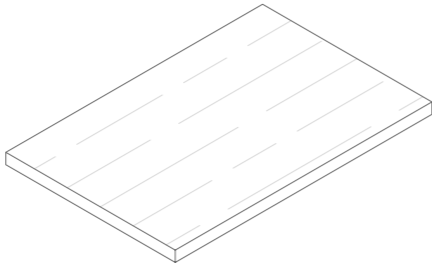

DESCRIPTION:

- Loose Shelf.
- Finished to match Doors.

SH-SPECIES

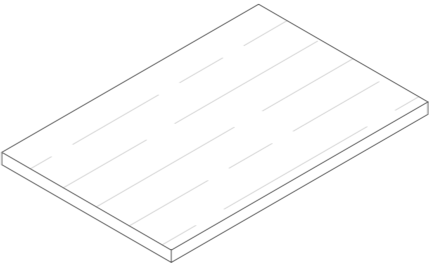

DESCRIPTION:

- Loose Shelf.
- Finish will match Interior Finish.

SH-INT

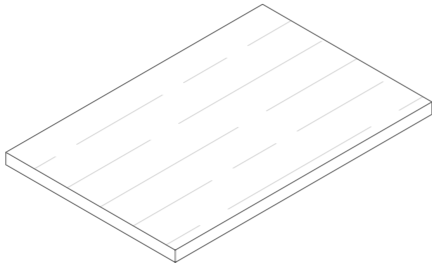

DESCRIPTION:

- Adds additional Shelf to a Cabinet.
- Finished to Match Doors.
- Includes additional drilling charge & Shelf Clips.

SHELF-SPECIES

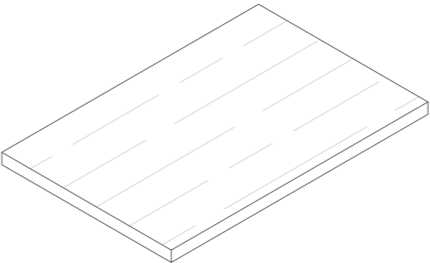

DESCRIPTION:

- Adds additional Shelf to a Cabinet.
- Finish will match Interior Finish.
- Includes additional drilling charge & Shelf Clips.

SHELF-INT

FLOATING SHELF:

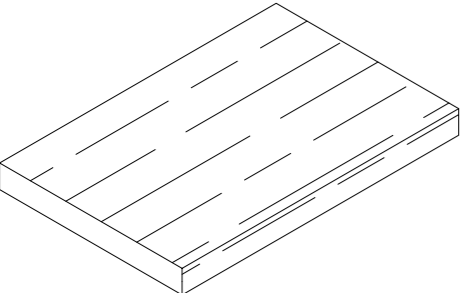

SHELF SPECIFICATIONS:

DESCRIPTION:
-Floating Shelf that includes wall mounting bracket.
-Front & Side Edges will be finished.

WIDTH:
-24"W to 96"W.
-Minimum Width: 12"W.

DEPTH:
-12 3/4"D.
-Minimum Depth: 9"D.

GRAIN DIRECTION:
-Runs along the width of the Shelf.
-Edges will always be horizontal grain.

WEIGHT LIMITATIONS:
-Maximum 15 kg (33 lb) per shelf bracket
(when installed correctly).

SPECIES AVAILABLE:

- Alder, Clear [ALDC]
- Alder, Knotty [ALDK]
- Cherry [CH]
- Laminate [LAM]
- Maple [MA]
- MDF [MDF]
- Oak, Red Flat [OAK]
- Oak, White Flat [OAKWF]
- Oak, White Rift [OAKWR]
- P.E.T. [PET]
- Walnut [WA]

PROFILE:

CROSS-SECTION VIEW

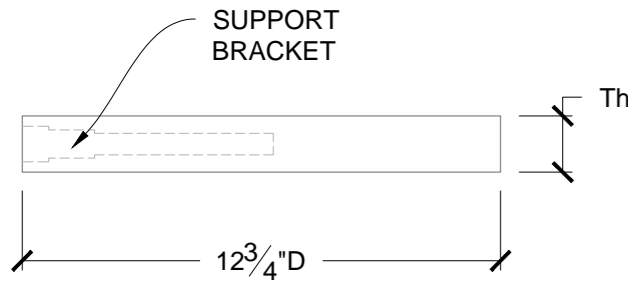

SKU'S:

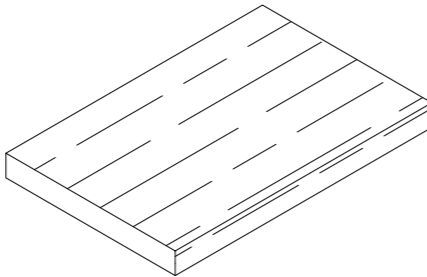

DESCRIPTION:
-1 1/2"Thick Shelf.

FLSH1.5-SPECIES-W

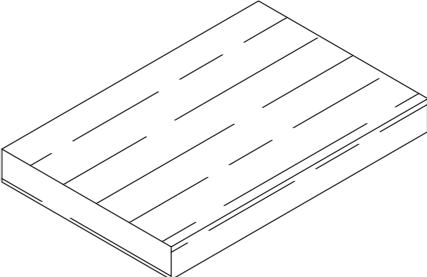

DESCRIPTION:
-2"Thick Shelf.

FLSH2-SPECIES-W



MOULDINGS

TOEKICKS & BASEBOARDS

Lengths over 96" may be available in some materials by Custom Quote Only. Oversized Handling Charges may apply.

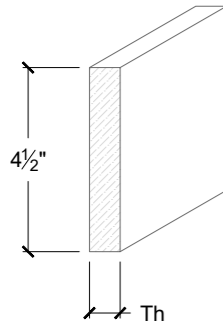

TK-M1-SPECIES

SPECIFICATIONS:

- DESCRIPTION:**
 -Veneer/Laminate Toe Kick.
 -Finished on Face & both Long Edges.
- LENGTHS:**
 -96"L.
- THICKNESS:**
 -Will match cabinet construction (Laminates & P.E.T. excluded).
- GRAIN DIRECTION:**
 -Horizontal.

SPECIES AVAILABLE:

- Alder, Clear [ALDC]
- Alder, Knotty [ALDK]
- Cherry [CH]
- Laminate [LAM]
- Maple [MA]
- Oak, Red Flat [OAK]
- Oak, White Flat [OAKWF]
- Oak, White Rift [OAKWR]
- P.E.T. [PET]
- Walnut [WA]

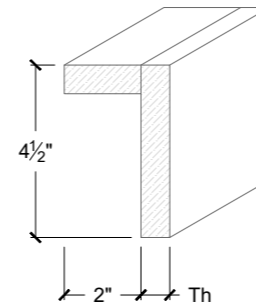

TK-M1CT-SPECIES

SPECIFICATIONS:

- DESCRIPTION:**
 -Veneer/Laminate Toe Kick with Finished Cleat.
 -Finished on Face, Cleat & both Long Edges.
- LENGTHS:**
 -96"L.
- THICKNESS:**
 -Will match cabinet construction (Laminates & P.E.T. excluded).
- GRAIN DIRECTION:**
 -Horizontal.

SPECIES AVAILABLE:

- Alder, Clear [ALDC]
- Alder, Knotty [ALDK]
- Cherry [CH]
- Laminate [LAM]
- Maple [MA]
- Oak, Red Flat [OAK]
- Oak, White Flat [OAKWF]
- Oak, White Rift [OAKWR]
- P.E.T. [PET]
- Walnut [WA]

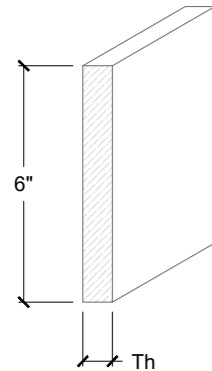

TK-M1-6H-SPECIES

SPECIFICATIONS:

- DESCRIPTION:**
 -Veneer/Laminate Toe Kick.
 -Finished on Face & both Long Edges.
- LENGTHS:**
 -96"L.
- THICKNESS:**
 -Will match cabinet construction (Laminates & P.E.T. excluded).
- GRAIN DIRECTION:**
 -Horizontal.

SPECIES AVAILABLE:

- Alder, Clear [ALDC]
- Alder, Knotty [ALDK]
- Cherry [CH]
- Laminate [LAM]
- Maple [MA]
- Oak, Red Flat [OAK]
- Oak, White Flat [OAKWF]
- Oak, White Rift [OAKWR]
- P.E.T. [PET]
- Walnut [WA]

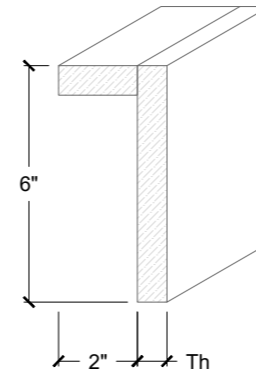

TK-M1CT-6H-SPECIES

SPECIFICATIONS:

- DESCRIPTION:**
 -Veneer/Laminate Toe Kick with Finished Cleat.
 -Finished on Face, Cleat & both Long Edges.
- LENGTHS:**
 -96"L.
- THICKNESS:**
 -Will match cabinet construction (Laminates & P.E.T. excluded).
- GRAIN DIRECTION:**
 -Horizontal.

SPECIES AVAILABLE:

- Alder, Clear [ALDC]
- Alder, Knotty [ALDK]
- Cherry [CH]
- Laminate [LAM]
- Maple [MA]
- Oak, Red Flat [OAK]
- Oak, White Flat [OAKWF]
- Oak, White Rift [OAKWR]
- P.E.T. [PET]
- Walnut [WA]

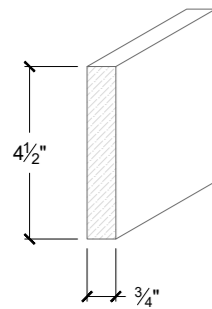

TK-M2-SPECIES

SPECIFICATIONS:

- DESCRIPTION:**
 -Solid Wood/MDF Toe Kick.
 -Finished on Face & both Long Edges.
- LENGTHS:**
 -96"L.
- GRAIN DIRECTION:**
 -Horizontal.

SPECIES AVAILABLE:

- Alder, Clear [ALDC]
- Alder, Knotty [ALDK]
- Cherry [CH]
- Maple [MA]
- MDF [MDF]
- Oak, Red Flat [OAK]
- Oak, White Flat [OAKWF]
- Oak, White Rift [OAKWR]
- Walnut [WA]

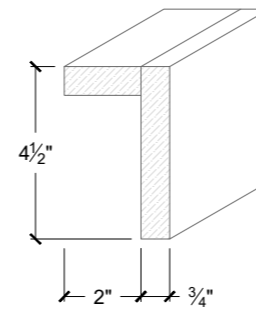

TK-M2CT-SPECIES

SPECIFICATIONS:

- DESCRIPTION:**
 -Solid Wood/MDF Toe Kick with Finished Cleat.
 -Finished on Face & both Long Edges.
- LENGTHS:**
 -96"L.
- GRAIN DIRECTION:**
 -Horizontal.

SPECIES AVAILABLE:

- Alder, Clear [ALDC]
- Alder, Knotty [ALDK]
- Cherry [CH]
- Maple [MA]
- MDF [MDF]
- Oak, Red Flat [OAK]
- Oak, White Flat [OAKWF]
- Oak, White Rift [OAKWR]
- Walnut [WA]

TOEKICKS & BASEBOARDS

Lengths over 96" may be available in some materials by Custom Quote Only. Oversized Handling Charges may apply.

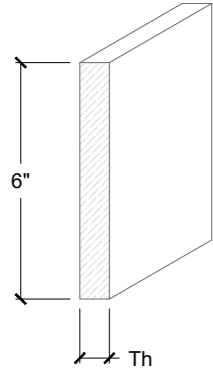

SPECIFICATIONS:

DESCRIPTION:
- Solid Wood/MDF Toe Kick.
- Finished on Face & both Long Edges.

LENGTHS:
- 96"L.

GRAIN DIRECTION:
- Horizontal.

SPECIES AVAILABLE:

- Alder, Clear [ALDC]
- Alder, Knotty [ALDK]
- Cherry [CH]
- Maple [MA]
- MDF [MDF]
- Oak, Red Flat [OAK]
- Oak, White Flat [OAKWF]
- Oak, White Rift [OAKWR]
- Walnut [WA]

TK-M2-6H-SPECIES

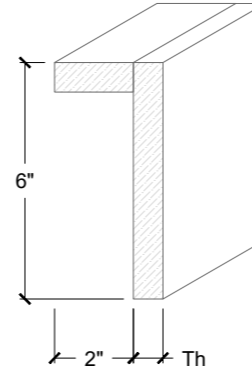

SPECIFICATIONS:

DESCRIPTION:
- Solid Wood/MDF Toe Kick with Finished Cleat.
- Finished on Face & both Long Edges.

LENGTHS:
- 96"L.

GRAIN DIRECTION:
- Horizontal.

SPECIES AVAILABLE:

- Alder, Clear [ALDC]
- Alder, Knotty [ALDK]
- Cherry [CH]
- Maple [MA]
- MDF [MDF]
- Oak, Red Flat [OAK]
- Oak, White Flat [OAKWF]
- Oak, White Rift [OAKWR]
- Walnut [WA]

TK-M2CT-6H-SPECIES

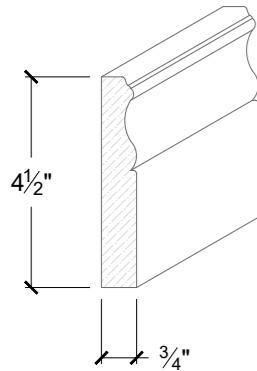

SPECIFICATIONS:

DESCRIPTION:
- Solid Wood Carved Moulding.
- Finished on Face & Top Edge.

LENGTHS:
- 96"L.

GRAIN DIRECTION:
- Horizontal.

SPECIES AVAILABLE:

- Alder, Clear [ALDC]
- Alder, Knotty [ALDK]
- Cherry [CH]
- Maple [MA]
- MDF [MDF]
- Oak, Red Flat [OAK]
- Oak, White Flat [OAKWF]
- Oak, White Rift [OAKWR]
- Walnut [WA]

TK-M3-SPECIES

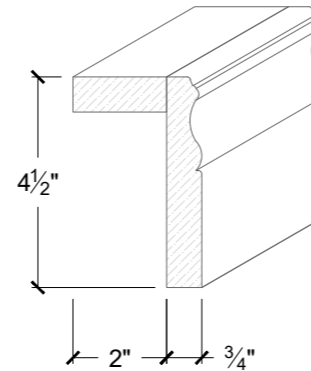

SPECIFICATIONS:

DESCRIPTION:
- Solid Wood Carved Moulding with Finished Cleat.
- Finished on Face & Top Edge.

LENGTHS:
- 96"L.

GRAIN DIRECTION:
- Horizontal.

SPECIES AVAILABLE:

- Alder, Clear [ALDC]
- Alder, Knotty [ALDK]
- Cherry [CH]
- Maple [MA]
- MDF [MDF]
- Oak, Red Flat [OAK]
- Oak, White Flat [OAKWF]
- Oak, White Rift [OAKWR]
- Walnut [WA]

TK-M3CT-SPECIES

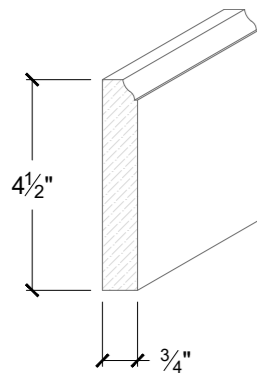

SPECIFICATIONS:

DESCRIPTION:
- Solid Wood with Door Matched Outside Profile.
- Profile will match Door Style listed in header.
- Finished on Face & Top Edge.

LENGTHS:
- 96"L.

GRAIN DIRECTION:
- Horizontal.

SPECIES AVAILABLE:

- Alder, Clear [ALDC]
- Alder, Knotty [ALDK]
- Cherry [CH]
- Maple [MA]
- MDF [MDF]
- Oak, Red Flat [OAK]
- Oak, White Flat [OAKWF]
- Oak, White Rift [OAKWR]
- Walnut [WA]

TK-M4-SPECIES

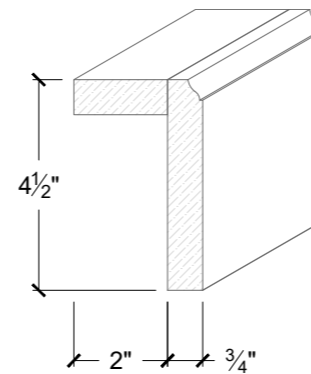

SPECIFICATIONS:

DESCRIPTION:
- Solid Wood with Door Matched Outside Profile with Finished Cleat.
- Profile will match Door Style listed in header.
- Finished on Face & Top.

LENGTHS:
- 96"L.

GRAIN DIRECTION:
- Horizontal.

SPECIES AVAILABLE:

- Alder, Clear [ALDC]
- Alder, Knotty [ALDK]
- Cherry [CH]
- Maple [MA]
- MDF [MDF]
- Oak, Red Flat [OAK]
- Oak, White Flat [OAKWF]
- Oak, White Rift [OAKWR]
- Walnut [WA]

TK-M4CT-SPECIES

TOEKICKS & BASEBOARDS

Lengths over 96" may be available in some materials by Custom Quote Only. Oversized Handling Charges may apply.

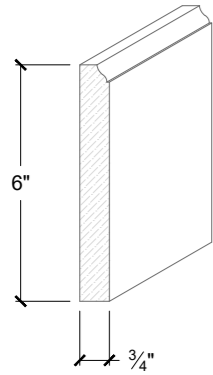

SPECIFICATIONS:

- DESCRIPTION:
 - Solid Wood with Door Matched Outside Profile.
 - Profile will match Door Style listed in header.
 - Finished on Face & Top Edge.
- LENGTHS:
 - 96"L.
- GRAIN DIRECTION:
 - Horizontal.

SPECIES AVAILABLE:

- Alder, Clear [ALDC]
- Alder, Knotty [ALDK]
- Cherry [CH]
- Maple [MA]
- MDF [MDF]
- Oak, Red Flat [OAK]
- Oak, White Flat [OAKWF]
- Oak, White Rift [OAKWR]
- Walnut [WA]

TK-M4-6H-SPECIES

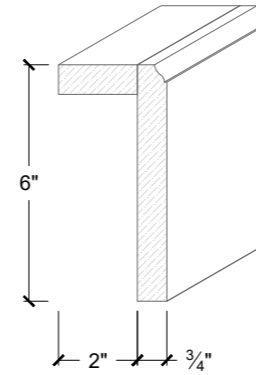

SPECIFICATIONS:

- DESCRIPTION:
 - Solid Wood with Door Matched Outside Profile with Finished Cleat.
 - Profile will match Door Style listed in header.
 - Finished on Face & Top.
- LENGTHS:
 - 96"L.
- GRAIN DIRECTION:
 - Horizontal.

SPECIES AVAILABLE:

- Alder, Clear [ALDC]
- Alder, Knotty [ALDK]
- Cherry [CH]
- Maple [MA]
- MDF [MDF]
- Oak, Red Flat [OAK]
- Oak, White Flat [OAKWF]
- Oak, White Rift [OAKWR]
- Walnut [WA]

TK-M4CT-6H-SPECIES

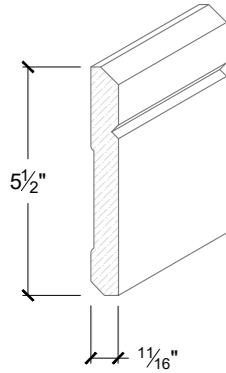

SPECIFICATIONS:

- DESCRIPTION:
 - Solid Wood Carved Moulding.
 - Finished on Face & Top Edge.
- LENGTHS:
 - 96"L.
- GRAIN DIRECTION:
 - Horizontal.

SPECIES AVAILABLE:

- Alder, Clear [ALDC]
- Alder, Knotty [ALDK]
- Cherry [CH]
- Maple [MA]
- Oak, Red Flat [OAK]
- Oak, White Flat [OAKWF]
- Oak, White Rift [OAKWR]
- Walnut [WA]

TK-001-SPECIES

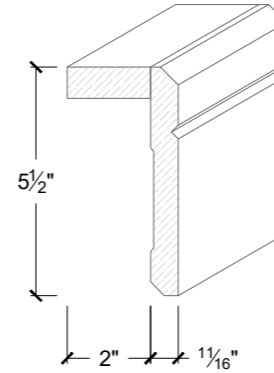

SPECIFICATIONS:

- DESCRIPTION:
 - Solid Wood Carved Moulding with Finished Cleat.
 - Finished on Face & Top Edge.
- LENGTHS:
 - 96"L.
- GRAIN DIRECTION:
 - Horizontal.

SPECIES AVAILABLE:

- Alder, Clear [ALDC]
- Alder, Knotty [ALDK]
- Cherry [CH]
- Maple [MA]
- Oak, Red Flat [OAK]
- Oak, White Flat [OAKWF]
- Oak, White Rift [OAKWR]
- Walnut [WA]

TK-001CT-SPECIES

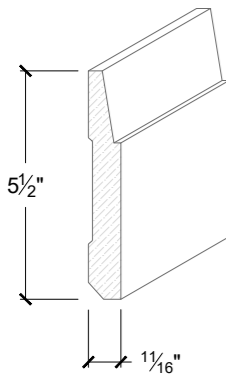

SPECIFICATIONS:

- DESCRIPTION:
 - Solid Wood Carved Moulding.
 - Finished on Face & Top Edge.
- LENGTHS:
 - 96"L.
- GRAIN DIRECTION:
 - Horizontal.

SPECIES AVAILABLE:

- Alder, Clear [ALDC]
- Alder, Knotty [ALDK]
- Cherry [CH]
- Maple [MA]
- Oak, Red Flat [OAK]
- Oak, White Flat [OAKWF]
- Oak, White Rift [OAKWR]
- Walnut [WA]

TK-131-SPECIES

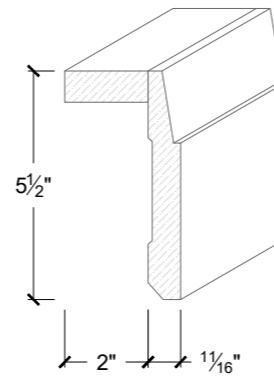

SPECIFICATIONS:

- DESCRIPTION:
 - Solid Wood Carved Moulding with Finished Cleat.
 - Finished on Face & Top Edge.
- LENGTHS:
 - 96"L.
- GRAIN DIRECTION:
 - Horizontal.

SPECIES AVAILABLE:

- Alder, Clear [ALDC]
- Alder, Knotty [ALDK]
- Cherry [CH]
- Maple [MA]
- Oak, Red Flat [OAK]
- Oak, White Flat [OAKWF]
- Oak, White Rift [OAKWR]
- Walnut [WA]

TK-131CT-SPECIES

CROWN

Lengths over 96" may be available in some materials by Custom Quote Only. Oversized Handling Charges may apply.

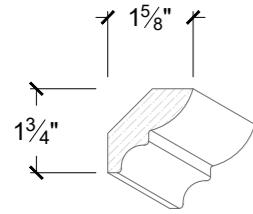

SPECIFICATIONS:

DESCRIPTION:
- Solid Wood carved Crown Moulding.
- Finished on Face & Bottom.

LENGTHS:
- 96"L.
GRAIN DIRECTION:
- Horizontal.

SPECIES AVAILABLE:

- Alder, Clear [ALDC]
- Alder, Knotty [ALDK]
- Cherry [CH]
- Maple [MA]
- Oak, Red Flat [OAK]
- Oak, White Flat [OAKWF]
- Oak, White Rift [OAKWR]
- Walnut [WA]

T3-101-SPECIES

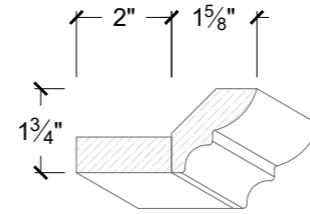

SPECIFICATIONS:

DESCRIPTION:
- Solid Wood carved Crown Moulding with Finished Cleat.
- Finished on Face & Bottom.

LENGTHS:
- 96"L.
GRAIN DIRECTION:
- Horizontal.

SPECIES AVAILABLE:

- Alder, Clear [ALDC]
- Alder, Knotty [ALDK]
- Cherry [CH]
- Maple [MA]
- Oak, Red Flat [OAK]
- Oak, White Flat [OAKWF]
- Oak, White Rift [OAKWR]
- Walnut [WA]

T3-101CT-SPECIES

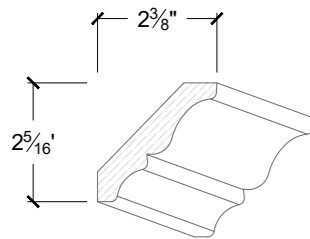

SPECIFICATIONS:

DESCRIPTION:
- Solid Wood carved Crown Moulding.
- Finished on Face & Bottom.

LENGTHS:
- 96"L.
GRAIN DIRECTION:
- Horizontal.

SPECIES AVAILABLE:

- Alder, Clear [ALDC]
- Alder, Knotty [ALDK]
- Cherry [CH]
- Maple [MA]
- Oak, Red Flat [OAK]
- Oak, White Flat [OAKWF]
- Oak, White Rift [OAKWR]
- Walnut [WA]

T3-102-SPECIES

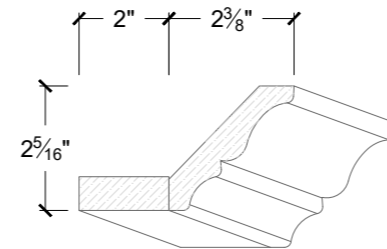

SPECIFICATIONS:

DESCRIPTION:
- Solid Wood carved Crown Moulding with Finished Cleat.
- Finished on Face & Bottom.

LENGTHS:
- 96"L.
GRAIN DIRECTION:
- Horizontal.

SPECIES AVAILABLE:

- Alder, Clear [ALDC]
- Alder, Knotty [ALDK]
- Cherry [CH]
- Maple [MA]
- Oak, Red Flat [OAK]
- Oak, White Flat [OAKWF]
- Oak, White Rift [OAKWR]
- Walnut [WA]

T3-102CT-SPECIES

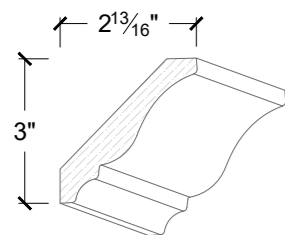

SPECIFICATIONS:

DESCRIPTION:
- Solid Wood carved Crown Moulding.
- Finished on Face & Bottom.

LENGTHS:
- 96"L.
GRAIN DIRECTION:
- Horizontal.

SPECIES AVAILABLE:

- Alder, Clear [ALDC]
- Alder, Knotty [ALDK]
- Cherry [CH]
- Maple [MA]
- Oak, Red Flat [OAK]
- Oak, White Flat [OAKWF]
- Oak, White Rift [OAKWR]
- Walnut [WA]

T3-103-SPECIES

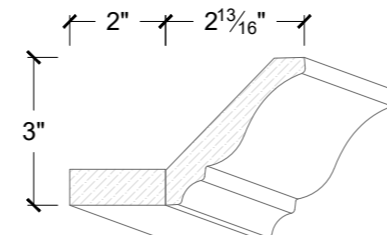

SPECIFICATIONS:

DESCRIPTION:
- Solid Wood carved Crown Moulding with Finished Cleat.
- Finished on Face & Bottom.

LENGTHS:
- 96"L.
GRAIN DIRECTION:
- Horizontal.

SPECIES AVAILABLE:

- Alder, Clear [ALDC]
- Alder, Knotty [ALDK]
- Cherry [CH]
- Maple [MA]
- Oak, Red Flat [OAK]
- Oak, White Flat [OAKWF]
- Oak, White Rift [OAKWR]
- Walnut [WA]

T3-103CT-SPECIES

CROWN

Lengths over 96" may be available in some materials by Custom Quote Only. Oversized Handling Charges may apply.

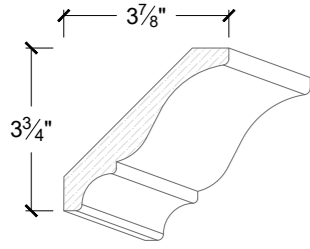

SPECIFICATIONS:

DESCRIPTION:
- Solid Wood carved Crown Moulding.
- Finished on Face & Bottom.

LENGTHS:
- 96"L.

GRAIN DIRECTION:
- Horizontal.

SPECIES AVAILABLE:

- Alder, Clear [ALDC]
- Alder, Knotty [ALDK]
- Cherry [CH]
- Maple [MA]
- Oak, Red Flat [OAK]
- Oak, White Flat [OAKWF]
- Oak, White Rift [OAKWR]
- Walnut [WA]

T3-104-SPECIES

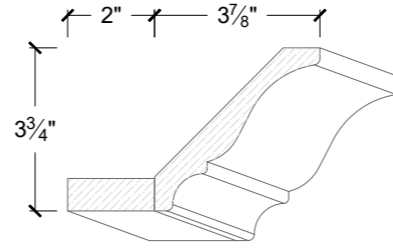

SPECIFICATIONS:

DESCRIPTION:
- Solid Wood carved Crown Moulding with Finished Cleat.
- Finished on Face & Bottom.

LENGTHS:
- 96"L.

GRAIN DIRECTION:
- Horizontal.

SPECIES AVAILABLE:

- Alder, Clear [ALDC]
- Alder, Knotty [ALDK]
- Cherry [CH]
- Maple [MA]
- Oak, Red Flat [OAK]
- Oak, White Flat [OAKWF]
- Oak, White Rift [OAKWR]
- Walnut [WA]

T3-104CT-SPECIES

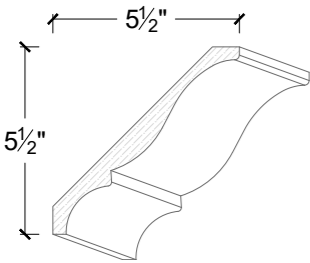

SPECIFICATIONS:

DESCRIPTION:
- Solid Wood carved Crown Moulding.
- Finished on Face & Bottom.

LENGTHS:
- 96"L.

GRAIN DIRECTION:
- Horizontal.

SPECIES AVAILABLE:

- Alder, Clear [ALDC]
- Alder, Knotty [ALDK]
- Cherry [CH]
- Maple [MA]
- Oak, Red Flat [OAK]
- Oak, White Flat [OAKWF]
- Oak, White Rift [OAKWR]
- Walnut [WA]

T3-105-SPECIES

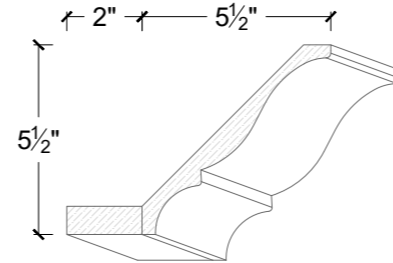

SPECIFICATIONS:

DESCRIPTION:
- Solid Wood carved Crown Moulding with Finished Cleat.
- Finished on Face & Bottom.

LENGTHS:
- 96"L.

GRAIN DIRECTION:
- Horizontal.

SPECIES AVAILABLE:

- Alder, Clear [ALDC]
- Alder, Knotty [ALDK]
- Cherry [CH]
- Maple [MA]
- Oak, Red Flat [OAK]
- Oak, White Flat [OAKWF]
- Oak, White Rift [OAKWR]
- Walnut [WA]

T3-105CT-SPECIES

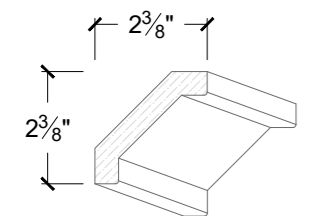

SPECIFICATIONS:

DESCRIPTION:
- Solid Wood carved Crown Moulding.
- Finished on Face & Bottom.

LENGTHS:
- 96"L.

GRAIN DIRECTION:
- Horizontal.

SPECIES AVAILABLE:

- Alder, Clear [ALDC]
- Alder, Knotty [ALDK]
- Cherry [CH]
- Maple [MA]
- Oak, Red Flat [OAK]
- Oak, White Flat [OAKWF]
- Oak, White Rift [OAKWR]
- Walnut [WA]

T3-111-SPECIES

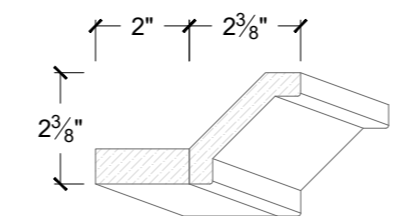

SPECIFICATIONS:

DESCRIPTION:
- Solid Wood carved Crown Moulding with Finished Cleat.
- Finished on Face & Bottom.

LENGTHS:
- 96"L.

GRAIN DIRECTION:
- Horizontal.

SPECIES AVAILABLE:

- Alder, Clear [ALDC]
- Alder, Knotty [ALDK]
- Cherry [CH]
- Maple [MA]
- Oak, Red Flat [OAK]
- Oak, White Flat [OAKWF]
- Oak, White Rift [OAKWR]
- Walnut [WA]

T3-111CT-SPECIES

CROWN

Lengths over 96" may be available in some materials by Custom Quote Only. Oversized Handling Charges may apply.

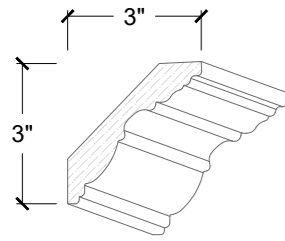

SPECIFICATIONS:

DESCRIPTION:
-Solid Wood carved Crown Moulding.
-Finished on Face & Bottom.

LENGTHS:
-96"L.

GRAIN DIRECTION:
-Horizontal.

SPECIES AVAILABLE:

-Alder, Clear [ALDC]
-Alder, Knotty [ALDK]
-Cherry [CH]
-Maple [MA]
-Oak, Red Flat [OAK]
-Oak, White Flat [OAKWF]
-Oak, White Rift [OAKWR]
-Walnut [WA]

T3-116-SPECIES

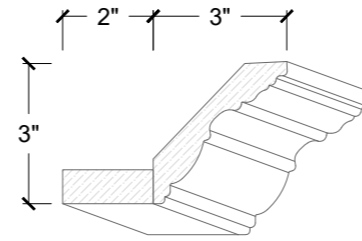

SPECIFICATIONS:

DESCRIPTION:
-Solid Wood carved Crown Moulding with Finished Cleat.
-Finished on Face & Bottom.

LENGTHS:
-96"L.

GRAIN DIRECTION:
-Horizontal.

SPECIES AVAILABLE:

-Alder, Clear [ALDC]
-Alder, Knotty [ALDK]
-Cherry [CH]
-Maple [MA]
-Oak, Red Flat [OAK]
-Oak, White Flat [OAKWF]
-Oak, White Rift [OAKWR]
-Walnut [WA]

T3-116CT-SPECIES

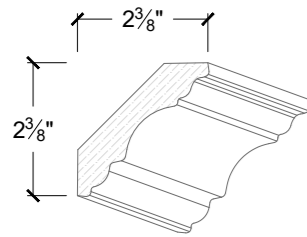

SPECIFICATIONS:

DESCRIPTION:
-Solid Wood carved Crown Moulding.
-Finished on Face & Bottom.

LENGTHS:
-96"L.

GRAIN DIRECTION:
-Horizontal.

SPECIES AVAILABLE:

-Alder, Clear [ALDC]
-Alder, Knotty [ALDK]
-Cherry [CH]
-Maple [MA]
-Oak, Red Flat [OAK]
-Oak, White Flat [OAKWF]
-Oak, White Rift [OAKWR]
-Walnut [WA]

T3-118-SPECIES

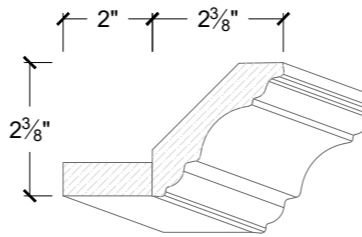

SPECIFICATIONS:

DESCRIPTION:
-Solid Wood carved Crown Moulding with Finished Cleat.
-Finished on Face & Bottom.

LENGTHS:
-96"L.

GRAIN DIRECTION:
-Horizontal.

SPECIES AVAILABLE:

-Alder, Clear [ALDC]
-Alder, Knotty [ALDK]
-Cherry [CH]
-Maple [MA]
-Oak, Red Flat [OAK]
-Oak, White Flat [OAKWF]
-Oak, White Rift [OAKWR]
-Walnut [WA]

T3-118CT-SPECIES

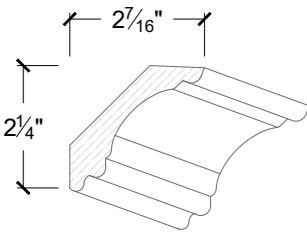

SPECIFICATIONS:

DESCRIPTION:
-Solid Wood carved Crown Moulding.
-Finished on Face & Bottom.

LENGTHS:
-96"L.

GRAIN DIRECTION:
-Horizontal.

SPECIES AVAILABLE:

-Alder, Clear [ALDC]
-Alder, Knotty [ALDK]
-Cherry [CH]
-Maple [MA]
-Oak, Red Flat [OAK]
-Oak, White Flat [OAKWF]
-Oak, White Rift [OAKWR]
-Walnut [WA]

T3-121-SPECIES

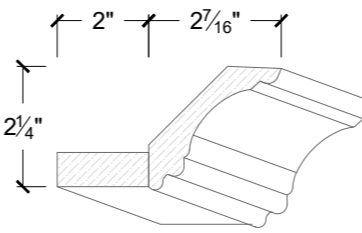

SPECIFICATIONS:

DESCRIPTION:
-Solid Wood carved Crown Moulding with Finished Cleat.
-Finished on Face & Bottom.

LENGTHS:
-96"L.

GRAIN DIRECTION:
-Horizontal.

SPECIES AVAILABLE:

-Alder, Clear [ALDC]
-Alder, Knotty [ALDK]
-Cherry [CH]
-Maple [MA]
-Oak, Red Flat [OAK]
-Oak, White Flat [OAKWF]
-Oak, White Rift [OAKWR]
-Walnut [WA]

T3-121CT-SPECIES

CROWN

Lengths over 96" may be available in some materials by Custom Quote Only. Oversized Handling Charges may apply.

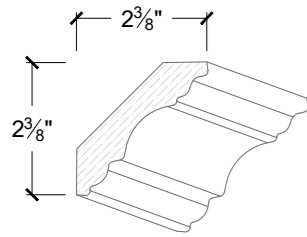

SPECIFICATIONS:

DESCRIPTION:
- Solid Wood carved Crown Moulding.
- Finished on Face & Bottom.

LENGTHS:
- 96"L.

GRAIN DIRECTION:
- Horizontal.

SPECIES AVAILABLE:

- Alder, Clear [ALDC]
- Alder, Knotty [ALDK]
- Cherry [CH]
- Maple [MA]
- Oak, Red Flat [OAK]
- Oak, White Flat [OAKWF]
- Oak, White Rift [OAKWR]
- Walnut [WA]

T3-122-SPECIES

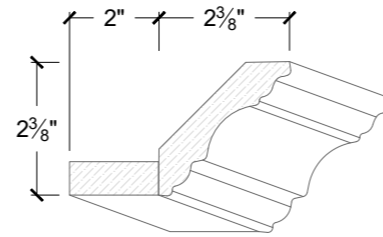

SPECIFICATIONS:

DESCRIPTION:
- Solid Wood carved Crown Moulding with Finished Cleat.
- Finished on Face & Bottom.

LENGTHS:
- 96"L.

GRAIN DIRECTION:
- Horizontal.

SPECIES AVAILABLE:

- Alder, Clear [ALDC]
- Alder, Knotty [ALDK]
- Cherry [CH]
- Maple [MA]
- Oak, Red Flat [OAK]
- Oak, White Flat [OAKWF]
- Oak, White Rift [OAKWR]
- Walnut [WA]

T3-122CT-SPECIES

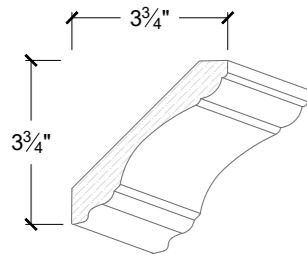

SPECIFICATIONS:

DESCRIPTION:
- Solid Wood carved Crown Moulding.
- Finished on Face & Bottom.

LENGTHS:
- 96"L.

GRAIN DIRECTION:
- Horizontal.

SPECIES AVAILABLE:

- Alder, Clear [ALDC]
- Alder, Knotty [ALDK]
- Cherry [CH]
- Maple [MA]
- Oak, Red Flat [OAK]
- Oak, White Flat [OAKWF]
- Oak, White Rift [OAKWR]
- Walnut [WA]

T3-123-SPECIES

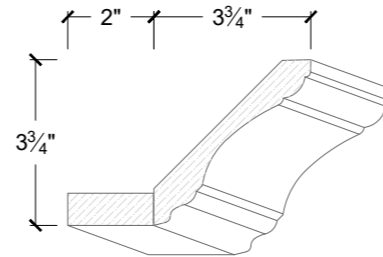

SPECIFICATIONS:

DESCRIPTION:
- Solid Wood carved Crown Moulding with Finished Cleat.
- Finished on Face & Bottom.

LENGTHS:
- 96"L.

GRAIN DIRECTION:
- Horizontal.

SPECIES AVAILABLE:

- Alder, Clear [ALDC]
- Alder, Knotty [ALDK]
- Cherry [CH]
- Maple [MA]
- Oak, Red Flat [OAK]
- Oak, White Flat [OAKWF]
- Oak, White Rift [OAKWR]
- Walnut [WA]

T3-123CT-SPECIES

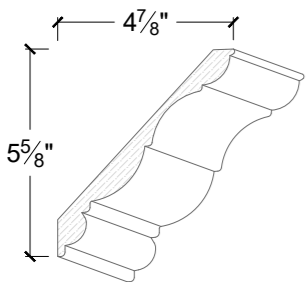

SPECIFICATIONS:

DESCRIPTION:
- Solid Wood carved Crown Moulding.
- Finished on Face & Bottom.

LENGTHS:
- 96"L.

GRAIN DIRECTION:
- Horizontal.

SPECIES AVAILABLE:

- Alder, Clear [ALDC]
- Alder, Knotty [ALDK]
- Cherry [CH]
- Maple [MA]
- Oak, Red Flat [OAK]
- Oak, White Flat [OAKWF]
- Oak, White Rift [OAKWR]
- Walnut [WA]

T3-128-SPECIES

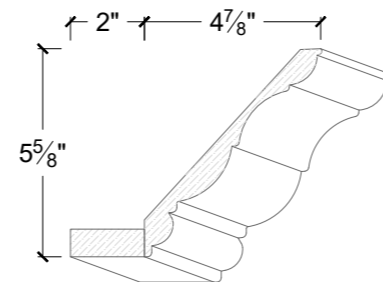

SPECIFICATIONS:

DESCRIPTION:
- Solid Wood carved Crown Moulding with Finished Cleat.
- Finished on Face & Bottom.

LENGTHS:
- 96"L.

GRAIN DIRECTION:
- Horizontal.

SPECIES AVAILABLE:

- Alder, Clear [ALDC]
- Alder, Knotty [ALDK]
- Cherry [CH]
- Maple [MA]
- Oak, Red Flat [OAK]
- Oak, White Flat [OAKWF]
- Oak, White Rift [OAKWR]
- Walnut [WA]

T3-128CT-SPECIES

CROWN

Lengths over 96" may be available in some materials by Custom Quote Only. Oversized Handling Charges may apply.

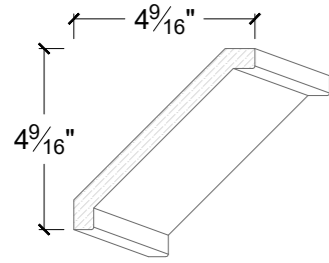

SPECIFICATIONS:

DESCRIPTION:
- Solid Wood carved Crown Moulding.
- Finished on Face & Bottom.

LENGTHS:
- 96"L

GRAIN DIRECTION:
- Horizontal.

SPECIES AVAILABLE:

- Alder, Clear [ALDC]
- Alder, Knotty [ALDK]
- Cherry [CH]
- Maple [MA]
- Oak, Red Flat [OAK]
- Oak, White Flat [OAKWF]
- Oak, White Rift [OAKWR]
- Walnut [WA]

T3-141-SPECIES

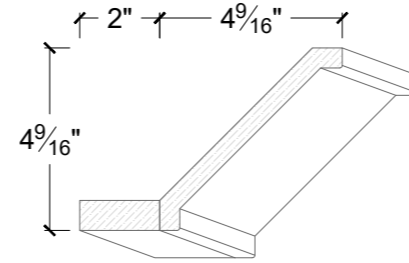

SPECIFICATIONS:

DESCRIPTION:
- Solid Wood carved Crown Moulding with Finished Cleat.
- Finished on Face & Bottom.

LENGTHS:
- 96"L

GRAIN DIRECTION:
- Horizontal.

SPECIES AVAILABLE:

- Alder, Clear [ALDC]
- Alder, Knotty [ALDK]
- Cherry [CH]
- Maple [MA]
- Oak, Red Flat [OAK]
- Oak, White Flat [OAKWF]
- Oak, White Rift [OAKWR]
- Walnut [WA]

T3-141CT-SPECIES

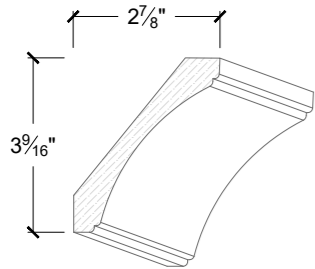

SPECIFICATIONS:

DESCRIPTION:
- Solid Wood carved Crown Moulding.
- Finished on Face & Bottom.

LENGTHS:
- 96"L

GRAIN DIRECTION:
- Horizontal.

SPECIES AVAILABLE:

- Alder, Clear [ALDC]
- Alder, Knotty [ALDK]
- Cherry [CH]
- Maple [MA]
- Oak, Red Flat [OAK]
- Oak, White Flat [OAKWF]
- Oak, White Rift [OAKWR]
- Walnut [WA]

T3-142-SPECIES

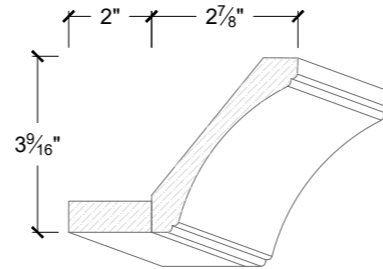

SPECIFICATIONS:

DESCRIPTION:
- Solid Wood carved Crown Moulding with Finished Cleat.
- Finished on Face & Bottom.

LENGTHS:
- 96"L

GRAIN DIRECTION:
- Horizontal.

SPECIES AVAILABLE:

- Alder, Clear [ALDC]
- Alder, Knotty [ALDK]
- Cherry [CH]
- Maple [MA]
- Oak, Red Flat [OAK]
- Oak, White Flat [OAKWF]
- Oak, White Rift [OAKWR]
- Walnut [WA]

T3-142CT-SPECIES

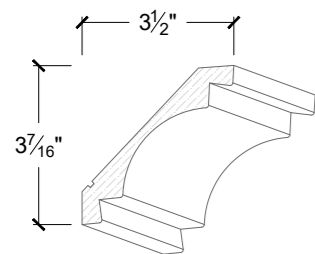

SPECIFICATIONS:

DESCRIPTION:
- Solid Wood carved Crown Moulding.
- Finished on Face & Bottom.

LENGTHS:
- 96"L

GRAIN DIRECTION:
- Horizontal.

SPECIES AVAILABLE:

- Alder, Clear [ALDC]
- Alder, Knotty [ALDK]
- Cherry [CH]
- Maple [MA]
- Oak, Red Flat [OAK]
- Oak, White Flat [OAKWF]
- Oak, White Rift [OAKWR]
- Walnut [WA]

T3-153-SPECIES

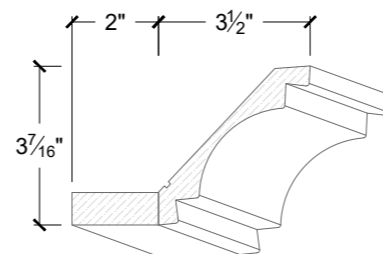

SPECIFICATIONS:

DESCRIPTION:
- Solid Wood carved Crown Moulding with Finished Cleat.
- Finished on Face & Bottom.

LENGTHS:
- 96"L

GRAIN DIRECTION:
- Horizontal.

SPECIES AVAILABLE:

- Alder, Clear [ALDC]
- Alder, Knotty [ALDK]
- Cherry [CH]
- Maple [MA]
- Oak, Red Flat [OAK]
- Oak, White Flat [OAKWF]
- Oak, White Rift [OAKWR]
- Walnut [WA]

T3-153CT-SPECIES

CROWN

Lengths over 96" may be available in some materials by Custom Quote Only. Oversized Handling Charges may apply.

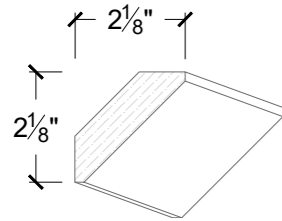

SPECIFICATIONS:

DESCRIPTION:
 - Solid Wood carved Crown Moulding.
 - Finished on Face & Bottom.

LENGTHS:
 -96"L.

GRAIN DIRECTION:
 -Horizontal.

SPECIES AVAILABLE:

-Alder, Clear [ALDC]
 -Alder, Knotty [ALDK]
 -Cherry [CH]
 -Maple [MA]
 -Oak, Red Flat [OAK]
 -Oak, White Flat [OAKWF]
 -Oak, White Rift [OAKWR]
 -Walnut [WA]

CRN-01-SPECIES

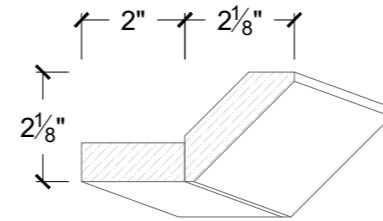

SPECIFICATIONS:

DESCRIPTION:
 - Solid Wood carved Crown Moulding with Finished Cleat.
 - Finished on Face & Bottom.

LENGTHS:
 -96"L.

GRAIN DIRECTION:
 -Horizontal.

SPECIES AVAILABLE:

-Alder, Clear [ALDC]
 -Alder, Knotty [ALDK]
 -Cherry [CH]
 -Maple [MA]
 -Oak, Red Flat [OAK]
 -Oak, White Flat [OAKWF]
 -Oak, White Rift [OAKWR]
 -Walnut [WA]

CRN-01CT-SPECIES

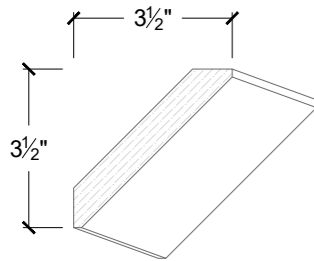

SPECIFICATIONS:

DESCRIPTION:
 - Solid Wood carved Crown Moulding.
 - Finished on Face & Bottom.

LENGTHS:
 -96"L.

GRAIN DIRECTION:
 -Horizontal.

SPECIES AVAILABLE:

-Alder, Clear [ALDC]
 -Alder, Knotty [ALDK]
 -Cherry [CH]
 -Maple [MA]
 -Oak, Red Flat [OAK]
 -Oak, White Flat [OAKWF]
 -Oak, White Rift [OAKWR]
 -Walnut [WA]

CRN-02-SPECIES

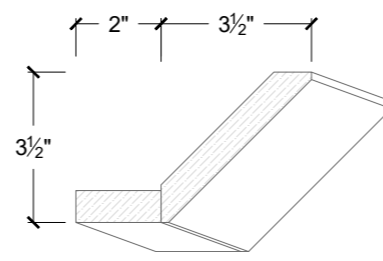

SPECIFICATIONS:

DESCRIPTION:
 - Solid Wood carved Crown Moulding with Finished Cleat.
 - Finished on Face & Bottom.

LENGTHS:
 -96"L.

GRAIN DIRECTION:
 -Horizontal.

SPECIES AVAILABLE:

-Alder, Clear [ALDC]
 -Alder, Knotty [ALDK]
 -Cherry [CH]
 -Maple [MA]
 -Oak, Red Flat [OAK]
 -Oak, White Flat [OAKWF]
 -Oak, White Rift [OAKWR]
 -Walnut [WA]

CRN-02CT-SPECIES

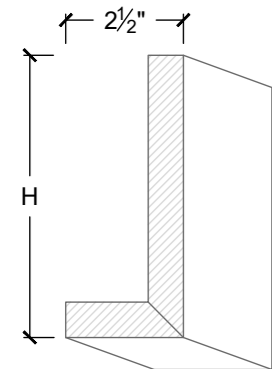

SPECIFICATIONS:

DESCRIPTION:
 - Veneered or Laminate Stacker Moulding.
 - Finished on Face & Bottom.

HEIGHTS:
 -6"H, 9"H, & 12"H.
 -Height can be reduced at no additional charge. Minimum: 3"H.

LENGTHS:
 -96"L.

GRAIN DIRECTION:
 -Horizontal.

SPECIES AVAILABLE:

-Alder, Clear [ALDC]
 -Alder, Knotty [ALDK]
 -Cherry [CH]
 -Laminate [LAM]
 -Maple [MA]
 -MDF [MDF]
 -Oak, Red Flat [OAK]
 -Oak, White Flat [OAKWF]
 -Oak, White Rift [OAKWR]
 -P.E.T. [PET]
 -Walnut [WA]

L-RIS-HX96-SPECIES

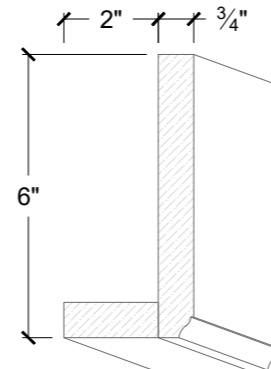

SPECIFICATIONS:

DESCRIPTION:
 - Solid Wood Stacker Moulding with Door Matched Outside Profile.
 - Finished on Face & Bottom.

HEIGHTS:
 -6"H.
 -Height can be reduced at no additional charge. Minimum: 3"H.

LENGTHS:
 -96"L.

GRAIN DIRECTION:
 -Horizontal.

SPECIES AVAILABLE:

-Alder, Clear [ALDC]
 -Alder, Knotty [ALDK]
 -Cherry [CH]
 -Maple [MA]
 -MDF [MDF]
 -Oak, Red Flat [OAK]
 -Oak, White Flat [OAKWF]
 -Oak, White Rift [OAKWR]
 -Walnut [WA]

L2-RIS-SPECIES

CROWN

Lengths over 96" may be available in some materials by Custom Quote Only. Oversized Handling Charges may apply.

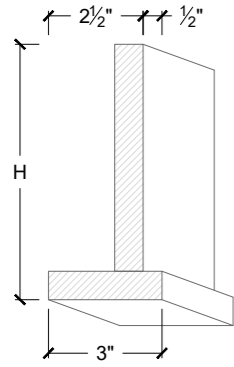

T1-RISER-HX96-SPECIES

SPECIFICATIONS:

DESCRIPTION:

- Veneered or Laminate
Stacker Moulding.
- Finished on Face & Bottom.

HEIGHTS:

- 6"H, 9"H, & 12"H.
- Height can be reduced at no additional charge. Minimum: 3"H.

LENGTHS:

- 96"L.

GRAIN DIRECTION:

- Horizontal.

SPECIES AVAILABLE:

- Alder, Clear [ALDC]
- Alder, Knotty [ALDK]
- Cherry [CH]
- Laminate [LAM]
- Maple [MA]
- MDF [MDF]
- Oak, Red Flat [OAK]
- Oak, White Flat [OAKWF]
- Oak, White Rift [OAKWR]
- P.E.T. [PET]
- Walnut [WA]

LIGHT VALANCES

Lengths over 96" may be available in some materials by Custom Quote Only. Oversized Handling Charges may apply.

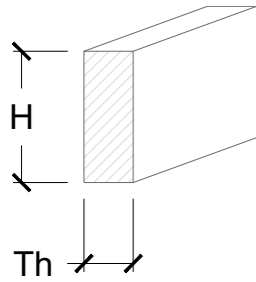

LV-01-SPECIES

SPECIFICATIONS:

DESCRIPTION:
 -Veneered, Laminate, or Solid MDF.
 -Finished Front & Back & 1 Long Edge.

HEIGHTS:
 -3"H.
 -Height can be reduced at no additional charge. Minimum: 1 1/2"H.

LENGTHS:
 -96"L.

GRAIN DIRECTION:
 -Horizontal.

SPECIES AVAILABLE:

-Alder, Clear [ALDC]
 -Alder, Knotty [ALDK]
 -Cherry [CH]
 -Laminate [LAM]
 -Maple [MA]
 -MDF [MDF]
 -Oak, Red Flat [OAK]
 -Oak, White Flat [OAKWF]
 -Oak, White Rift [OAKWR]
 -P.E.T. [PET]
 -Walnut [WA]

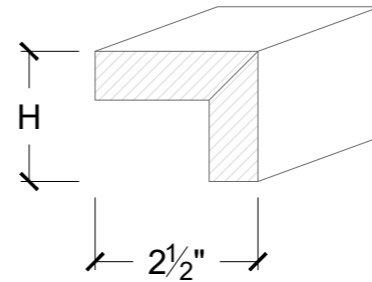

LV-01CT-SPECIES

SPECIFICATIONS:

DESCRIPTION:
 -Veneered, Laminate, or Solid MDF with Finished Cleat.

HEIGHTS:
 -3"H.
 -Height can be reduced at no additional charge. Minimum: 1 1/2"H.

LENGTHS:
 -96"L.

GRAIN DIRECTION:
 -Horizontal.

SPECIES AVAILABLE:

-Alder, Clear [ALDC]
 -Alder, Knotty [ALDK]
 -Cherry [CH]
 -Laminate [LAM]
 -Maple [MA]
 -MDF [MDF]
 -Oak, Red Flat [OAK]
 -Oak, White Flat [OAKWF]
 -Oak, White Rift [OAKWR]
 -P.E.T. [PET]
 -Walnut [WA]

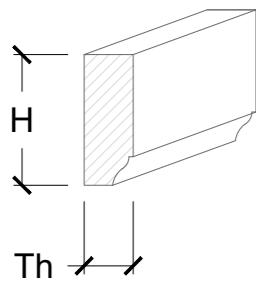

LV-02-SPECIES

SPECIFICATIONS:

DESCRIPTION:
 -Solid Wood/MDF with Door Matched Outside Profile.
 -Finished Front & Back & 1 Long Edge.

HEIGHTS:
 -3"H.
 -Height can be reduced at no additional charge. Minimum: 2"H.

LENGTHS:
 -96"L.

GRAIN DIRECTION:
 -Horizontal.

SPECIES AVAILABLE:

-Alder, Clear [ALDC]
 -Alder, Knotty [ALDK]
 -Cherry [CH]
 -Maple [MA]
 -MDF [MDF]
 -Oak, Red Flat [OAK]
 -Oak, White Flat [OAKWF]
 -Oak, White Rift [OAKWR]
 -Walnut [WA]

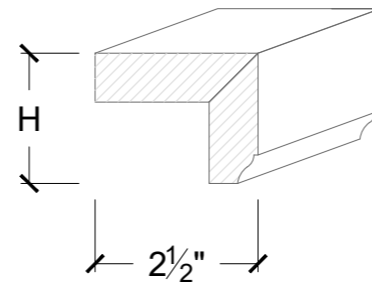

LV-02CT-SPECIES

SPECIFICATIONS:

DESCRIPTION:
 -Solid Wood/MDF with Door Matched Outside Profile.
 -Finished Front, Top, Underside & all long edges.

HEIGHTS:
 -3"H.
 -Height can be reduced at no additional charge. Minimum: 2"H.

LENGTHS:
 -96"L.

GRAIN DIRECTION:
 -Horizontal.

SPECIES AVAILABLE:

-Alder, Clear [ALDC]
 -Alder, Knotty [ALDK]
 -Cherry [CH]
 -Maple [MA]
 -MDF [MDF]
 -Oak, Red Flat [OAK]
 -Oak, White Flat [OAKWF]
 -Oak, White Rift [OAKWR]
 -Walnut [WA]

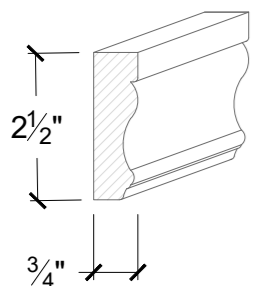

LV-03-SPECIES

SPECIFICATIONS:

DESCRIPTION:
 -Solid Wood/MDF Carved Moulding.
 -Finished Front & Back & Bottom Edge.

HEIGHTS:
 -2 1/2"H.

LENGTHS:
 -96"L.

GRAIN DIRECTION:
 -Horizontal.

SPECIES AVAILABLE:

-Alder, Clear [ALDC]
 -Alder, Knotty [ALDK]
 -Cherry [CH]
 -Maple [MA]
 -Oak, Red Flat [OAK]
 -Oak, White Flat [OAKWF]
 -Oak, White Rift [OAKWR]
 -Walnut [WA]

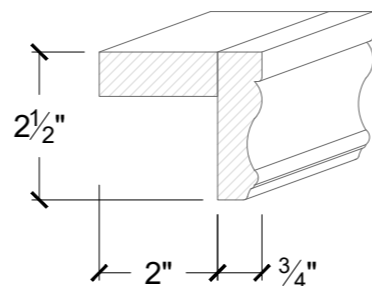

LV-03CT-SPECIES

SPECIFICATIONS:

DESCRIPTION:
 -Solid Wood/MDF Carved Moulding & Finished Cleat.
 -Finished Front, Top, Underside & all long edges.

HEIGHTS:
 -2 1/2"H.

LENGTHS:
 -96"L.

GRAIN DIRECTION:
 -Horizontal.

SPECIES AVAILABLE:

-Alder, Clear [ALDC]
 -Alder, Knotty [ALDK]
 -Cherry [CH]
 -Maple [MA]
 -Oak, Red Flat [OAK]
 -Oak, White Flat [OAKWF]
 -Oak, White Rift [OAKWR]
 -Walnut [WA]

LIGHT VALANCES

Lengths over 96" may be available in some materials by Custom Quote Only. Oversized Handling Charges may apply.

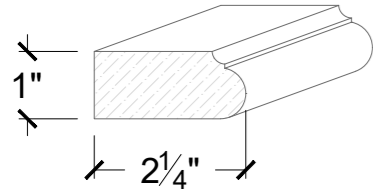

SPECIFICATIONS:

DESCRIPTION:

- Solid Wood carved Light Valance Moulding.
- Finished Front, Top, Underside & all long edges.

LENGTHS:

- 96"L.

GRAIN DIRECTION:

- Horizontal.

SPECIES AVAILABLE:

- Alder, Clear [ALDC]
- Alder, Knotty [ALDK]
- Cherry [CH]
- Maple [MA]
- Oak, Red Flat [OAK]
- Oak, White Flat [OAKWF]
- Oak, White Rift [OAKWR]
- Walnut [WA]

LV-119-SPECIES

MISCELLANEOUS

Lengths over 96" may be available in some materials by Custom Quote Only. Oversized Handling Charges may apply.

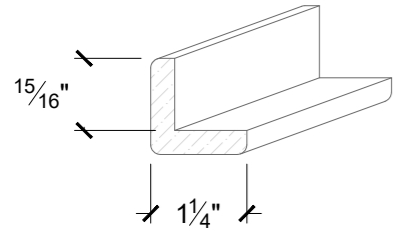

SPECIFICATIONS:

DESCRIPTION:
- Solid Wood Outside Corner Moulding.
- Finished Outside Edge & Long Edges.

LENGTHS:
- 96"L.

GRAIN DIRECTION:
- Horizontal.

SPECIES AVAILABLE:

- Alder, Clear [ALDC]
- Cherry [CH]
- Maple [MA]
- Oak, Red Flat [OAK]
- Oak, White Flat [OAKWF]
- Oak, White Rift [OAKWR]
- Walnut [WA]

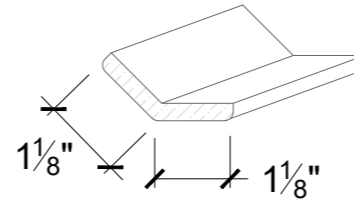

SPECIFICATIONS:

DESCRIPTION:
- Solid Wood Outside Corner Moulding.
- Finished Outside Edge & Long Edges.

LENGTHS:
- 96"L.

GRAIN DIRECTION:
- Horizontal.

SPECIES AVAILABLE:

- Alder, Clear [ALDC]
- Cherry [CH]
- Maple [MA]
- Oak, Red Flat [OAK]
- Oak, White Flat [OAKWF]
- Oak, White Rift [OAKWR]
- Walnut [WA]

OCM-SPECIES

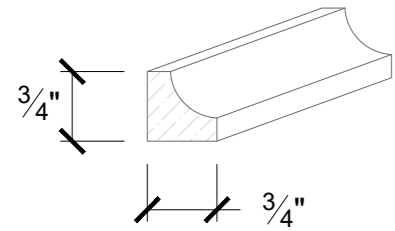

SPECIFICATIONS:

DESCRIPTION:
- Solid Wood Inside Corner Cove Moulding.
- Finished Inside Cove & Narrow Edges.

LENGTHS:
- 96"L.

GRAIN DIRECTION:
- Horizontal.

SPECIES AVAILABLE:

- Alder, Clear [ALDC]
- Alder, Knotty [ALDK]
- Cherry [CH]
- Maple [MA]
- Oak, Red Flat [OAK]
- Oak, White Flat [OAKWF]
- Oak, White Rift [OAKWR]
- Walnut [WA]

135OCM-SPECIES

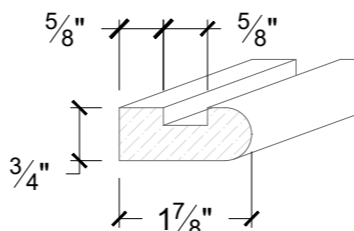

SPECIFICATIONS:

DESCRIPTION:
- Solid Wood Moulding.
- Finished on Bull-nose & Bottom only.

LENGTHS:
- 96"L.

GRAIN DIRECTION:
- Horizontal.

SPECIES AVAILABLE:

- Alder, Clear [ALDC]
- Alder, Knotty [ALDK]
- Cherry [CH]
- Maple [MA]
- Oak, Red Flat [OAK]
- Oak, White Flat [OAKWF]
- Oak, White Rift [OAKWR]
- Walnut [WA]

COVM-SPECIES

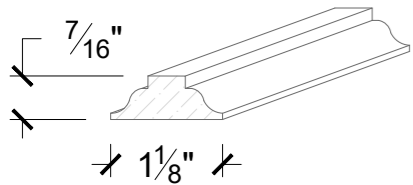

SPECIFICATIONS:

DESCRIPTION:
- Solid Wood Moulding.
- Finished on Top & Side edges.

LENGTHS:
- 96"L.

GRAIN DIRECTION:
- Horizontal.

SPECIES AVAILABLE:

- Alder, Clear [ALDC]
- Alder, Knotty [ALDK]
- Cherry [CH]
- Maple [MA]
- Oak, Red Flat [OAK]
- Oak, White Flat [OAKWF]
- Oak, White Rift [OAKWR]
- Walnut [WA]

BLN-SPECIES

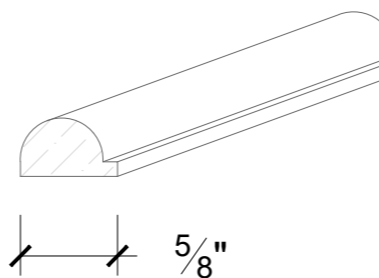

SPECIFICATIONS:

DESCRIPTION:
- Solid Wood Moulding.
- Finished on Top & Side edges.

LENGTHS:
- 96"L.

GRAIN DIRECTION:
- Horizontal.

SPECIES AVAILABLE:

- Alder, Clear [ALDC]
- Alder, Knotty [ALDK]
- Cherry [CH]
- Maple [MA]
- Oak, Red Flat [OAK]
- Oak, White Flat [OAKWF]
- Oak, White Rift [OAKWR]
- Walnut [WA]

AP-M1-SPECIES

AP-M3-SPECIES

MISCELLANEOUS

Lengths over 96" may be available in some materials by Custom Quote Only. Oversized Handling Charges may apply.

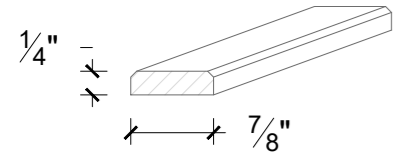

SPECIFICATIONS:

DESCRIPTION:
 -Solid Wood Moulding.
 -Finished on Top & Side edges.

LENGTHS:
 -96"L.

GRAIN DIRECTION:
 -Horizontal.

SPECIES AVAILABLE:

-Alder, Clear [ALDC]
 -Cherry [CH]
 -Maple [MA]
 -Oak, Red Flat [OAK]
 -Oak, White Flat [OAKWF]
 -Oak, White Rift [OAKWR]
 -Walnut [WA]

TM-001-SPECIES

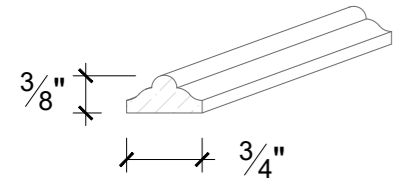

SPECIFICATIONS:

DESCRIPTION:
 -Solid Wood Moulding.
 -Finished on Top & Side edges.

LENGTHS:
 -96"L.

GRAIN DIRECTION:
 -Horizontal.

SPECIES AVAILABLE:

-Alder, Clear [ALDC]
 -Cherry [CH]
 -Maple [MA]
 -Oak, Red Flat [OAK]
 -Oak, White Flat [OAKWF]
 -Oak, White Rift [OAKWR]
 -Walnut [WA]

TM-123-SPECIES

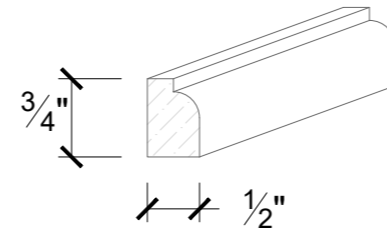

SPECIFICATIONS:

DESCRIPTION:
 -Solid Wood Moulding.
 -Finished on Top & Side edges.

LENGTHS:
 -96"L.

GRAIN DIRECTION:
 -Horizontal.

SPECIES AVAILABLE:

-Alder, Clear [ALDC]
 -Cherry [CH]
 -Maple [MA]
 -Oak, Red Flat [OAK]
 -Oak, White Flat [OAKWF]
 -Oak, White Rift [OAKWR]
 -Walnut [WA]

TM-117-SPECIES



MODIFICATIONS

PANELS

UPDATED: MAY 15, 2023

CABINET BOX

Size increases are subject to Möbel approval as structural integrity, material sizes, & handling precautions need to be taken into consideration.

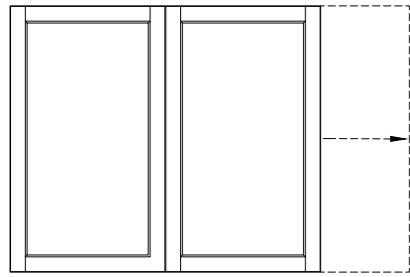

SPECIFICATIONS:

DESCRIPTION:

- Increase the Width of the Cabinet beyond the maximum standard option.

CONSIDERATIONS:

- Only available when a larger size isn't listed in MOS.
- Cabinet may void warranty & structural variations may be recommended.
- Subject to Möbel approval.

INCREASE-W

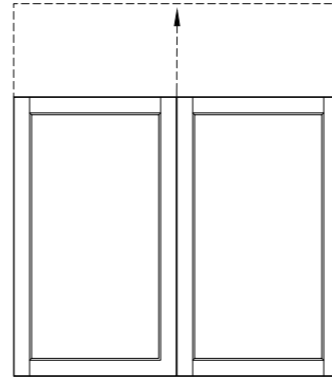

SPECIFICATIONS:

DESCRIPTION:

- Increase the Height of the Cabinet beyond the maximum standard option.

CONSIDERATIONS:

- Only available when a larger size isn't listed in MOS.
- Depending on Cabinet design & material, visible seams may be required.
- Cabinet may void warranty & structural variations may be recommended.
- Subject to Möbel approval.

INCREASE-H

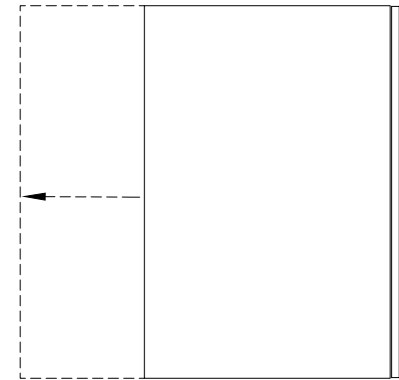

SPECIFICATIONS:

DESCRIPTION:

- Increase the Depth of the Cabinet beyond the maximum standard option.

CONSIDERATIONS:

- Only available when a larger size isn't listed in MOS.
- Cabinet may void warranty & structural variations may be recommended.
- Subject to Möbel approval.

INCREASE-D

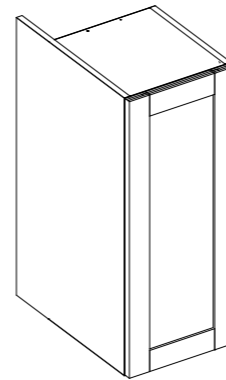

SPECIFICATIONS:

DESCRIPTION:

- Extend Cabinet Side Back.

CONSIDERATIONS:

- Maximum extension: 18".
- Inside finish of extension will match cabinet interior.

ESBACK

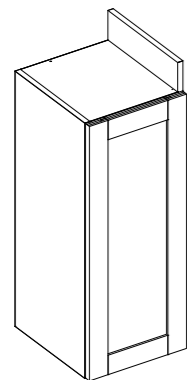

SPECIFICATIONS:

DESCRIPTION:

- Extend Cabinet Side Up.

CONSIDERATIONS:

- Maximum extension: 18".
- Inside finish of extension will match cabinet interior.

ESU

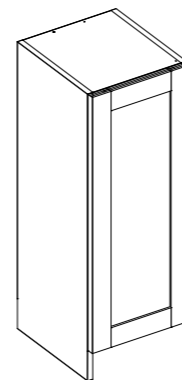

SPECIFICATIONS:

DESCRIPTION:

- Extend Cabinet Side Up.

CONSIDERATIONS:

- Maximum extension: 18".
- Inside finish of extension will match cabinet interior.

ESD

PANELS

CABINET BOX

Size increases are subject to Möbel approval as structural integrity, material sizes, & handling precautions need to be taken into consideration.

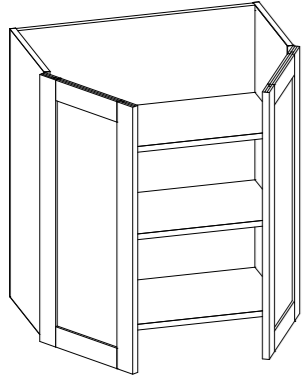

SPECIFICATIONS:

DESCRIPTION:

- Modify cabinet to be built without a top.

CONSIDERATIONS:

- It is recommended to have a fixed shelf near the top of the cabinet to maintain the structural integrity of the cabinet.
- Cabinet will be braced for shipping as required.

NOTOP

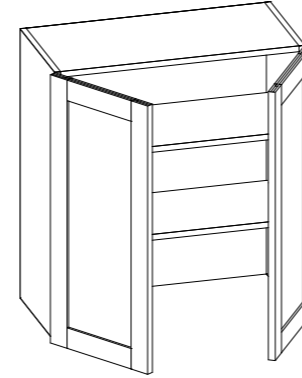

SPECIFICATIONS:

DESCRIPTION:

- Modify cabinet to be built without a bottom floor.

CONSIDERATIONS:

- It is recommended to have a fixed shelf near the bottom of the cabinet to maintain the structural integrity of the cabinet.
- Cabinet will be braced for shipping as required.

NOBOTTOM

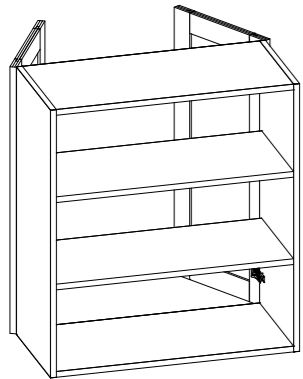

SPECIFICATIONS:

DESCRIPTION:

- Modify cabinet to be built without a back.
- Shelves & Floors will be extended back. Cabinet sides will not be routed.

CONSIDERATIONS:

- This modification will void the warranty of the cabinet. It is recommended that the cabinet be installed between adjacent cabinets or fixed floors/stretchers to keep the cabinet square.
- Cabinet will be braced for shipping as required.

NOBACK

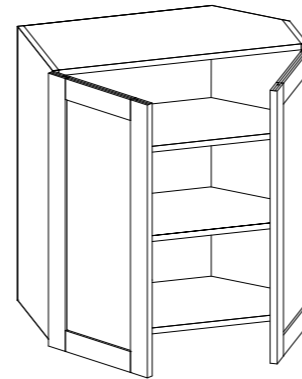

SPECIFICATIONS:

DESCRIPTION:

- Add an angled cut to the back corner of the cabinet.
- Can be added to any back corner.

SIZE LIMITATIONS:

- Cabinet sides must be minimum 4"D for hinging.

CONSIDERATIONS:

- A drawing is required showing the clip dimensions & location.
- Depending on the size of the angle, drawer boxes may be reduced in depth or removed completely. Adjustable shelves may be fixed for stability.
- Not recommended for cabinets with pull-out hardware.
- Subject to Möbel approval.

ANGBACK

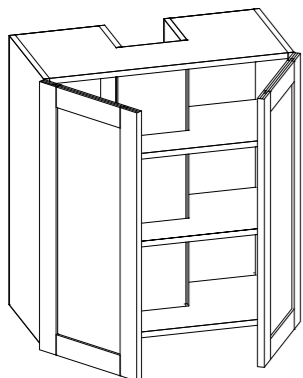

SPECIFICATIONS:

DESCRIPTION:

- Add a Box-Out in the Cabinet for plumbing, duct work, etc.

SIZE LIMITATIONS:

- Cabinet sides must be minimum 4"D for hinging.

CONSIDERATIONS:

- A drawing is required showing the dimensions & location.
- Depending on the size of the box-out, drawer boxes may be reduced in depth or removed completely. Adjustable shelves may be fixed for stability.
- Not recommended for cabinets with pull-out hardware.
- Subject to Möbel approval.

BOXOUT

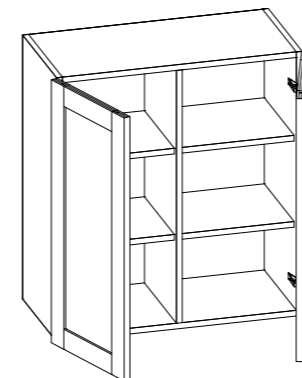

SPECIFICATIONS:

DESCRIPTION:

- Add a Fixed Partition to cabinet.
- Default location is centered.

CONSIDERATIONS:

- If cabinet has adjustable shelves, partition will be drilled for shelves on both sides unless specified otherwise.
- Subject to Möbel approval.

FIXPART

PANELS

CABINET BOX

Size increases are subject to Möbel approval as structural integrity, material sizes, & handling precautions need to be taken into consideration.

IMAGE
COMING
SOON

SPECIFICATIONS:

DESCRIPTION:

- Upgrade Shelf Holes from Cluster Drilling to Continuous.

CONSIDERATIONS:

- Subject to Möbel approval.

IMAGE
COMING
SOON

SPECIFICATIONS:

DESCRIPTION:

- Add feet to a Wall Cabinet or Cabinet that does not come standard with feet/toe kick.

CONSIDERATIONS:

- Subject to Möbel approval.

CONTINUOUS DRILLING

ADD TOE KICK

PANELS

FINISH MODIFICATIONS

IMAGE
COMING
SOON

SPECIFICATIONS:

DESCRIPTION:

-Finish the Interior of the cabinet.

CONSIDERATIONS:

-Does not include drawer boxes, pull-outs, or add-on accessories.
-For stacked cabinets, all sections will be finished. If only wanting 1 section finished, Möbel recommends ordering 2 separate cabinets with overlay panels to hide seams.

SPECIES AVAILABLE:

-Alder, Clear
-Alder Knotty
-Cherry
-Laminate
-Maple
-MDF
-Oak, Red Flat
-Oak, White Flat
-Oak, White Rift
-P.E.T.
-Walnut

INFT-SPECIES

IMAGE
COMING
SOON

SPECIFICATIONS:

DESCRIPTION:

-Upgrades the inside back of the cabinet to a different species & finish than listed in header.

CONSIDERATIONS:

-Does not include INFT Finished interior charge.
-Intended to be used as an add-on to the INFT modification.

SPECIES AVAILABLE:

-Alder, Clear
-Alder Knotty
-Cherry
-Laminate
-Maple
-MDF
-Oak, Red Flat
-Oak, White Flat
-Oak, White Rift
-P.E.T.
-Walnut

INTBACK-SPECIES

IMAGE
COMING
SOON

SPECIFICATIONS:

DESCRIPTION:

-Finish the Top of the Cabinet.

CONSIDERATIONS:

-The finished top sits between the 2 cabinet ends - seams will be visible.

SPECIES AVAILABLE:

-Alder, Clear
-Alder Knotty
-Cherry
-Laminate
-Maple
-MDF
-Oak, Red Flat
-Oak, White Flat
-Oak, White Rift
-P.E.T.
-Walnut

FTOP-SPECIES

IMAGE
COMING
SOON

SPECIFICATIONS:

DESCRIPTION:

-Finish the Bottom of the Cabinet.

CONSIDERATIONS:

-The finished bottom sits between the 2 cabinet ends - seams will be visible.

SPECIES AVAILABLE:

-Alder, Clear
-Alder Knotty
-Cherry
-Laminate
-Maple
-MDF
-Oak, Red Flat
-Oak, White Flat
-Oak, White Rift
-P.E.T.
-Walnut

FBOT-SPECIES

IMAGE
COMING
SOON

SPECIFICATIONS:

DESCRIPTION:

-Add a finished edge to a 5/8" to 3/4" Th Filler, Panel, Slab moulding, etc.

CONSIDERATIONS:

-Priced per edge.

SPECIES AVAILABLE:

-Alder, Clear
-Alder Knotty
-Cherry
-Laminate
-Maple
-MDF
-Oak, Red Flat
-Oak, White Flat
-Oak, White Rift
-P.E.T.
-Walnut

FIN-EDGE

IMAGE
COMING
SOON

SPECIFICATIONS:

DESCRIPTION:

-Finish the Back of the Door with Shader/Glaze/etc. to Match the Face.

CONSIDERATIONS:

-Painted doors (without glaze) will match the face by default.
-Priced per door.

PANELS

DOOR FIN BACK

DOOR MODIFICATIONS

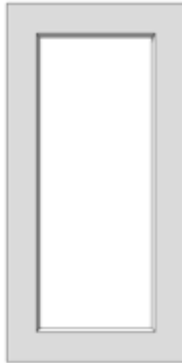

1LITE

SPECIFICATIONS:
DESCRIPTION:
-Upgrades Cabinet Door to an Open Frame Door routed for glass.
CONSIDERATIONS:
-Glass not included.
-INFT modification not included.
-Please refer to individual door style page for availability.
-Priced per door.



4LITE

SPECIFICATIONS:
DESCRIPTION:
-Upgrades Cabinet Door to a 4 Lite Mullion Door routed for glass.
CONSIDERATIONS:
-Glass not included.
-INFT modification not included.
-Please refer to individual door style page for availability.
-Priced per door.



6LITE

SPECIFICATIONS:
DESCRIPTION:
-Upgrades Cabinet Door to a 6 Lite Mullion Door routed for glass.
CONSIDERATIONS:
-Glass not included.
-INFT modification not included.
-Please refer to individual door style page for availability.
-Priced per door.



8LITE

SPECIFICATIONS:
DESCRIPTION:
-Upgrades Cabinet Door to a 8 Lite Mullion Door routed for glass.
CONSIDERATIONS:
-Glass not included.
-INFT modification not included.
-Please refer to individual door style page for availability.
-Priced per door.

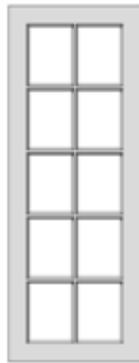

10LITE

SPECIFICATIONS:
DESCRIPTION:
-Upgrades Cabinet Door to a 10 Lite Mullion Door routed for glass.
CONSIDERATIONS:
-Glass not included.
-INFT modification not included.
-Please refer to individual door style page for availability.
-Priced per door.



12LITE

SPECIFICATIONS:
DESCRIPTION:
-Upgrades Cabinet Door to a 12 Lite Mullion Door routed for glass.
CONSIDERATIONS:
-Glass not included.
-INFT modification not included.
-Please refer to individual door style page for availability.
-Priced per door.

PANELS

DOOR MODIFICATIONS

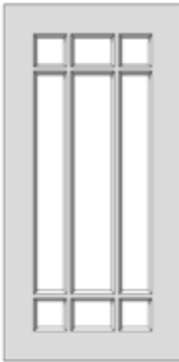

9LITE

SPECIFICATIONS:

DESCRIPTION:

- Upgrades Cabinet Door to a 9 Lite Mullion Door routed for glass.
- Corner lites are always 2 1/2" x 2 1/2".

SIZE LIMITATIONS:

- Minimum (2 1/4"W Door Rails): 13 1/2"W x 13 1/2"H
- Minimum size (2 1/2"W+ Door Rails): 15"W x 15"H

CONSIDERATIONS:

- Glass not included.
- INFT modification not included.
- Please refer to individual door style page for availability.
- Priced per door.

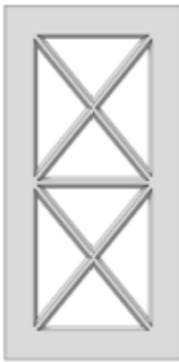

2XLITE

SPECIFICATIONS:

DESCRIPTION:

- Upgrades Cabinet Door to a 2-X Lite Mullion Door routed for glass.

CONSIDERATIONS:

- Glass not included.
- INFT modification not included.
- Available in MDF door styles only. Please refer to individual door style page for availability.
- Priced per door.

IMAGE
COMING
SOON

MODIFY DOORH CONFIG

SPECIFICATIONS:

DESCRIPTION:

- Modify the Door Heights on a Stacked or Tall Cabinet.
- Fixed Shelves will move with the Door Heights.

CONSIDERATIONS:

- Priced per cabinet.

IMAGE
COMING
SOON

MOVE DOOR CROSS RAIL

SPECIFICATIONS:

DESCRIPTION:

- Move the Cross Rail on tall doors to a new location.

CONSIDERATIONS:

- Submitting a drawing is recommended.

IMAGE
COMING
SOON

EXTD

SPECIFICATIONS:

DESCRIPTION:

- Extend cabinet doors beyond the cabinet.

CONSIDERATIONS:

- Priced per cabinet.

IMAGE
COMING
SOON

PIN 2 DOORS

SPECIFICATIONS:

DESCRIPTION:

- Pin 2 Doors together to function as 1 Door.

CONSIDERATIONS:

- Priced per joint.

PANELS

DOOR MODIFICATIONS



SPECIFICATIONS:
DESCRIPTION:
- Upgrade cabinet door with Blum Tip-On hardware for handle-less opening.
CONSIDERATIONS:
- Priced per door.

TIP ON DOOR



SPECIFICATIONS:
DESCRIPTION:
- Upgrade cabinet door to 155° opening hinges with zero protrusion into cabinets.
- Ideal for cabinets with roll-out drawers or other pull-outs.
CONSIDERATIONS:
- Priced per door.

MODIFY HINGE 155 ZERO



SPECIFICATIONS:
DESCRIPTION:
- Upgrade cabinet door with to 170° opening hinges.
CONSIDERATIONS:
- Priced per door.
- Does not include Soft Close.

MODIFY HINGE 170



SPECIFICATIONS:
DESCRIPTION:
- Modify 110° Hinge to 86° opening by installing an angle stop.
- The angle stop can be removed.
CONSIDERATIONS:
- Priced per door.

MODIFY HINGE LIMIT 86

DRAWER MODIFICATIONS

IMAGE
COMING
SOON

SPECIFICATIONS:

DESCRIPTION:

- Modify the Drawer Front Heights on a Cabinet.
- Drawer box heights will be adjusted accordingly.

CONSIDERATIONS:

- Priced per cabinet.

MODIFY DRAWERH CONFIG

IMAGE
COMING
SOON

SPECIFICATIONS:

DESCRIPTION:

- Add an additional 6"H Drawer to a Cabinet.
- Cabinet must already come standard with at least 1 drawer.
- Includes drawer front, box, & glides.

CONSIDERATIONS:

- Priced per additional drawer.
- Subject to Möbel approval.

ADD DRAWER SM



SPECIFICATIONS:

DESCRIPTION:

- Upgrade drawer with Blum Tip-On hardware for handle-less opening.

CONSIDERATIONS:

- Priced per drawer box.

TIP ON DRAWER

IMAGE
COMING
SOON

SPECIFICATIONS:

DESCRIPTION:

- Decrease Dovetail Drawer Box Height to a non-standard size.

CONSIDERATIONS:

- Priced per drawer box.

DRAWER HEIGHT DTAIL-DEC

IMAGE
COMING
SOON

SPECIFICATIONS:

DESCRIPTION:

- Add an additional Large (>6"H) Drawer to a Cabinet.
- Cabinet must already come standard with at least 1 drawer.
- Includes drawer front, box, & glides.

CONSIDERATIONS:

- Priced per additional drawer.
- Subject to Möbel approval.

ADD DRAWER LG

PANELS

ACCESSORIES

ROLL-OUTS

TANDEMBOX ROLL-OUT:



ROLL-OUT SPECIFICATIONS:

FINISH:

- Finish will match drawer box listed in header.

CONSTRUCTION:

- Fixed to cabinet sides.
- Door hinges will be upgrade to 155° Zero Protrusion hinges to eliminate need for spacers.
- Hinge location will be adjusted to accomodate Roll-Outs.

SIZE:

- Minimum cabinet width: 9"W.
- Minimum cabinet depth: 14 3/4"D.

NOTES:

- Please specify location in Notes.

CONSIDERATIONS:

- Existing interior components may be modified to allow space for Roll-Out.

SKU'S:



RO-TANDEM

DESCRIPTION:

- 3 5/8"H Roll-Out Drawer.

CLEARANCE REQUIREMENTS:

- 4 1/4"H.



RO-TANDEM 7H

DESCRIPTION:

- 6 3/4"H Roll-Out Drawer with Gallery Rail Pull.

CLEARANCE REQUIREMENTS:

- 7 5/8"H.



RO-TANDEM-LOOSE

DESCRIPTION:

- 3 5/8"H Roll-Out Drawer Shipped Loose.
- Includes drawer glides.

NOTES:

- Specify Drawer Box size or the size of the cabinet.
- Depth is limited by glide depth availability.



RO-TANDEM 7H-LOOSE

DESCRIPTION:

- 6 3/4"H Roll-Out Drawer with Gallery Rail Pull Shipped Loose.
- Includes drawer glides.

NOTES:

- Specify Drawer Box size or the size of the cabinet.
- Depth is limited by glide depth availability.

MERIVOBX ROLL-OUT:



ROLL-OUT SPECIFICATIONS:

FINISH:

-Finish will match drawer box listed in header.

CONSTRUCTION:

- Fixed to cabinet sides.
- Door hinges will be upgrade to 155° Zero Protrusion hinges to eliminate need for spacers.
- Hinge location will be adjusted to accommodate Roll-Outs.

SIZE:

- Minimum cabinet width: 9"W.
- Minimum cabinet depth: 14 3/4"D.

NOTES:

- Please specify location in Notes.
- MERIVOBX Drawer must be selected in the Room Header.

CONSIDERATIONS:

- Existing interior components may be modified to allow space for Roll-Out.

SKU'S:



RO-MERIVO

DESCRIPTION:

-3 5/8"H Roll-Out Drawer.

CLEARANCE REQUIREMENTS:

-4 1/4"H.



RO-MERIVO 7H GALLERY

DESCRIPTION:

-7 1/2"H Roll-Out Drawer with Gallery Rail Pull.
-Drawer Sides will match drawer box listed in header.

CLEARANCE REQUIREMENTS:

-8 1/4"H.



RO-MERIVO 7H GLASS

DESCRIPTION:

-7 1/2"H Roll-Out Drawer with Glass Front.
-Drawer Sides will match drawer box listed in header.

CLEARANCE REQUIREMENTS:

-8 1/4"H.

LEGRABOX ROLL-OUT:



ROLL-OUT SPECIFICATIONS:

FINISH:

- Finish will match drawer box listed in header.

CONSTRUCTION:

- Fixed to cabinet sides.
- Door hinges will be upgrade to 155° Zero Protrusion hinges to eliminate need for spacers.
- Hinge location will be adjusted to accomodate Roll-Outs.

SIZE:

- Minimum cabinet width: 9"W.
- Minimum cabinet depth: 14 3/4"D.

NOTES:

- Please specify location in Notes.
- LEGRABOX Drawer must be selected in the Room Header.

CONSIDERATIONS:

- Existing interior components may be modified to allow space for Roll-Out.

SKU'S:



RO-LEGRA FINISH

DESCRIPTION:

- 3 5/8"H Roll-Out Drawer.

CLEARANCE REQUIREMENTS:

- 4 1/8"H.



RO-LEGRA 7H GALLERY

DESCRIPTION:

- 7"H Roll-Out Drawer with Gallery Rail Pull.
- Drawer Sides will match drawer box listed in header.

CLEARANCE REQUIREMENTS:

- 7 5/8"H.



RO-LEGRA 7H GLASS

DESCRIPTION:

- 7"H Roll-Out Drawer with Glass Front.
- Drawer Sides will match drawer box listed in header.

CLEARANCE REQUIREMENTS:

- 7 5/8"H.

DOVETAIL ROLL-OUT:

IMAGE
COMING
SOON

ROLL-OUT SPECIFICATIONS:

CONSTRUCTION:

- Fixed to cabinet sides.
- Door hinges will be upgrade to 155° Zero Protrusion hinges to eliminate need for spacers.
- Hinge location will be adjusted to accomodate Roll-Outs.

SIZE:

- Minimum cabinet width: 9"W.
- Minimum cabinet depth: 14 3/4"D.

NOTES:

- Please specify location in Notes.
- DOVETAIL Drawer must be selected in the Room Header.

CONSIDERATIONS:

- Existing interior components may be modified to allow space for Roll-Out.

SKU'S:

IMAGE
COMING
SOON

DESCRIPTION:
-4"H Roll-Out Drawer.
CLEARANCE REQUIREMENTS:
-4 1/2"H.

RO-DOVETAIL

IMAGE
COMING
SOON

DESCRIPTION:
-8 1/4"H Roll-Out Drawer.
CLEARANCE REQUIREMENTS:
-9 1/4"H.

RO-DOVETAIL 8H

IMAGE
COMING
SOON

DESCRIPTION:
-4"H Roll-Out Drawer
with Scoop Handle.
CLEARANCE REQUIREMENTS:
-4 1/2"H.

RO-DOVETAIL SCOOP

IMAGE
COMING
SOON

DESCRIPTION:
-8 1/4"H Roll-Out Drawer
with Scoop Handle.
CLEARANCE REQUIREMENTS:
-9 1/4"H.

RO-DOVETAIL 8H SCOOP

DRAWER ORGANIZATION

ORGALINE TANDEMBOX DRAWER ORGANIZATION:



ORGALINE SPECIFICATIONS:

DESCRIPTION:

- Blum drawer dividers designed for Tandem Box.
- Divider units are removable & can be re-arranged.
- Components are dishwasher safe.
- Sets come with either a Utensil Divider with adjustable partition(s) or a Cutlery Tray with Removable Stainless Steel containers or a combination of both.

SIZE:

- For 500mm deep drawers (Base & Vanity depth).

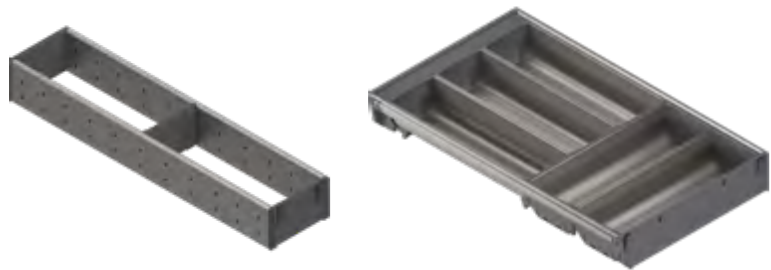

SKU'S:

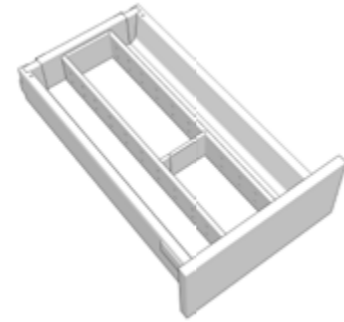

DESCRIPTION:

- Includes 1 - removable Utensil Divider with adjustable partition.

SIZE REQUIREMENTS:

- Minimum 12"W Cabinet.
- Designed for 3 5/8"H Drawer.

FINISH:

- Stainless Steel.

ORGALINE 12W - UTENSIL

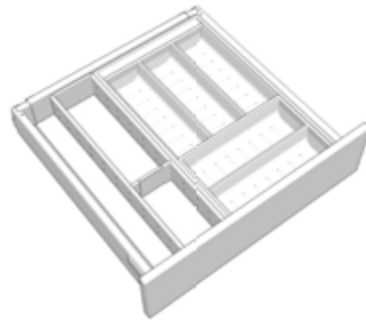

DESCRIPTION:

- Includes 1 - Cutlery Tray with removable containers & 1 - Utensil Divider with adjustable partition.

SIZE REQUIREMENTS:

- Minimum 21"W Cabinet.
- Designed for 3 5/8"H Drawer.

FINISH:

- Stainless Steel.

ORGALINE 21W - UTENSIL

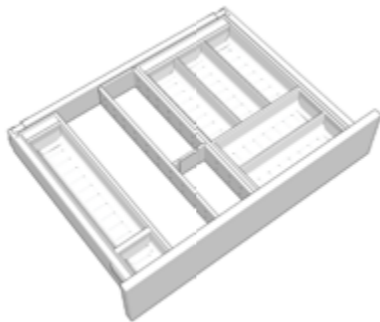

DESCRIPTION:

- Includes 2 - Cutlery Trays with removable containers & 1 - Utensil Divider with adjustable partition.

SIZE REQUIREMENTS:

- Minimum 27"W Cabinet.
- Designed for 3 5/8"H Drawer.

FINISH:

- Stainless Steel.

ORGALINE 27W - UTENSIL

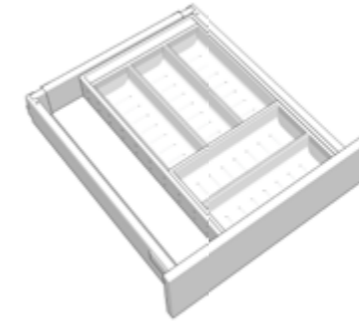

DESCRIPTION:

- Includes 1 - Cutlery Tray with removable containers.

SIZE REQUIREMENTS:

- Minimum 18"W Cabinet.
- Designed for 3 5/8"H Drawer.

FINISH:

- Stainless Steel.

ORGALINE 18W - UTENSIL

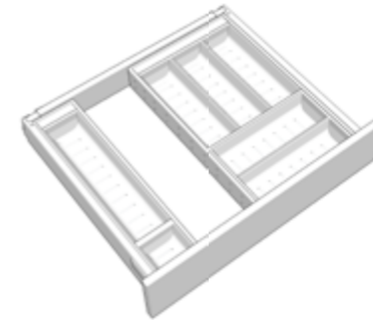

DESCRIPTION:

- Includes 2 - Cutlery Trays with removable containers.

SIZE REQUIREMENTS:

- Minimum 24"W Cabinet.
- Designed for 3 5/8"H Drawer.

FINISH:

- Stainless Steel.

ORGALINE 24W - UTENSIL



DESCRIPTION:

- Includes 1 - Cutlery Tray with removable containers & 1 - Large Utensil Divider with adjustable partitions.

SIZE REQUIREMENTS:

- Minimum 30"W Cabinet.
- Designed for 3 5/8"H Drawer.

FINISH:

- Stainless Steel.

ORGALINE 30W - UTENSIL

TANDEM ORGALINE DRAWER ORGANIZATION:



ORGALINE SPECIFICATIONS:

DESCRIPTION:

- Blum drawer dividers designed for Tandem Box.
- Divider units are removable & can be re-arranged.
- Components are dishwasher safe.

SIZE:

- For 500mm deep drawers (Base & Vanity depth).

SKU'S:



ORGALINE 21W - POTS LIDS

DESCRIPTION:

- Designed for Deep Drawer.
- Includes 1 - full width partition & 2 - 4" (nominal) adjustable partions.

SIZE REQUIREMENTS:

- Minimum 21"W Cabinet.

FINISH:

- Will match drawer box.



ORGALINE 33W - POTS LIDS

DESCRIPTION:

- Designed for Deep Drawer.
- Includes 1 - full width partition & 3 - 4" (nominal) adjustable partions.

SIZE REQUIREMENTS:

- Minimum 33"W Cabinet.

FINISH:

- Will match drawer box.

WOOD CUTLERY DOVETAIL DRAWER ORGANIZATION:



SPECIFICATIONS:

DESCRIPTION:

- Maple Cutlery Insert designed for Dovetail Drawers.
- Fits in 6"H drawers.

SIZE:

- Minimum Cabinet Depth: 20 3/4"D.

NOTES:

- Not compatible with Tandem drawer boxes.

SKU'S:



SIZE REQUIREMENTS:

- Maximum: 15 1/2"W Cabinet Opening (16 3/4"W or 17"W cabinet depending on Interior Finish).
- Minimum: 14 1/2"W Cabinet Opening (15 3/4"W or 16"W cabinet depending on Interior Finish).

WOOD CUTLERY 15.5W



SIZE REQUIREMENTS:

- Maximum: 19 1/2"W Cabinet Opening (20 3/4"W or 21"W cabinet depending on Interior Finish).
- Minimum: 13 3/4"W Cabinet Opening (15"W or 15 1/4"W cabinet depending on Interior Finish).

WOOD CUTLERY 19.5W



SIZE REQUIREMENTS:

- Maximum: 21 1/2"W Cabinet Opening (22 3/4"W or 23"W cabinet depending on Interior Finish).
- Minimum: 20 1/2"W Cabinet Opening (21 3/4"W or 22"W cabinet depending on Interior Finish).

WOOD CUTLERY 21.5W



SIZE REQUIREMENTS:

- Maximum: 25 1/2"W Cabinet Opening (26 3/4"W or 27"W cabinet depending on Interior Finish).
- Minimum: 17 3/4"W Cabinet Opening (19"W or 19 1/4"W cabinet depending on Interior Finish).

WOOD CUTLERY 25.5W



SIZE REQUIREMENTS:

- Maximum: 34 1/2"W Cabinet Opening (35 3/4"W or 36"W cabinet depending on Interior Finish).
- Minimum: 24 1/2"W Cabinet Opening (25 3/4"W or 26"W cabinet depending on Interior Finish). Some dividers will be removed at minimum width.

WOOD CUTLERY 34.5W



SIZE REQUIREMENTS:

- Maximum: 34 1/2"W Cabinet Opening (35 3/4"W or 36"W cabinet depending on Interior Finish).
- Minimum: 29 1/2"W Cabinet Opening (30 3/4"W or 31"W cabinet depending on Interior Finish). Some dividers will be removed at minimum width.

WOOD CUTLERY-KNIFE 34.5W

TIERED CUTLERY DOVETAIL

DRAWER ORGANIZATION:



SPECIFICATIONS:

DESCRIPTION:

- Upgrade a drawer box to a 2 Tier Maple Drawer Box with cutlery dividers.
- Top Tier slides back inside cabinet using ball-bearing slides.

SIZE:

- Minimum Cabinet Depth: 22 3/4"D.

NOTES:

- Must be added to a cabinet with an existing 6"H drawer.



SKU'S:



2TIER CUTLERY 13.5W

SIZE REQUIREMENTS:

- 13 1/2"W Cabinet Opening
(14 3/4"W or 15"W cabinet depending on Interior Finish).



2TIER CUTLERY 16.5W

SIZE REQUIREMENTS:

- 16 1/2"W Cabinet Opening
(17 3/4"W or 18"W cabinet depending on Interior Finish).



2TIER CUTLERY 19.5W

SIZE REQUIREMENTS:

- 19 1/2"W Cabinet Opening
(20 3/4"W or 21"W cabinet depending on Interior Finish).



2TIER CUTLERY 22.5W

SIZE REQUIREMENTS:

- 22 1/2"W Cabinet Opening
(23 3/4"W or 24"W cabinet depending on Interior Finish).

PEG BOARD DOVETAIL DRAWER ORGANIZATION:



SPECIFICATIONS:

DESCRIPTION:

- Maple Peg Board Insert designed for Dovetail Drawers.
- Fits in 12"H+ drawers.

SIZE:

- Minimum Cabinet Depth: 12 3/4"D.

NOTES:

- Not compatible with Tandem drawer boxes.



SKU'S:



PEGBOARD 25.5W

SIZE REQUIREMENTS:

- Maximum: 25 1/2"W Cabinet Opening (26 3/4"W or 27"W cabinet depending on Interior Finish).

PEG QUANTITY:

- 9 Pegs Included.

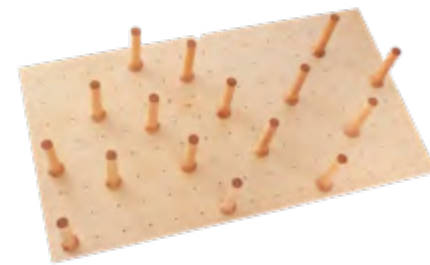

PEGBOARD 40.5W

SIZE REQUIREMENTS:

- Maximum: 40 1/2"W Cabinet Opening (41 3/4"W or 42"W cabinet depending on Interior Finish).

PEG QUANTITY:

- 16 Pegs Included.



PEGBOARD PEGS LOOSE

DESCRIPTION:

- 4 Wood Pegs.

NOTES:

- Shipped loose.
- Order as a stand-alone item (not a modification).



PEGBOARD 31.5W

SIZE REQUIREMENTS:

- Maximum: 31 1/2"W Cabinet Opening (26 3/4"W or 27"W cabinet depending on Interior Finish).

PEG QUANTITY:

- 12 Pegs Included.

TILT OUT SOAP TRAY DRAWER ORGANIZATION:



SPECIFICATIONS:

DESCRIPTION:

- Upgrade a fixed false drawer front to Tilt Out Soap Tray.
- Uses soft-close hinges.

NOTES:

- Must be added to a cabinet with an existing 6"H false drawer.
- Sink or appliance clearance must be taken into consideration. Möbel will not be responsible if hardware interferes with sink or appliance installation.



SKU'S:



DESCRIPTION:

- 25"W x 2 1/8"D Stainless Steel Tray.

SIZE REQUIREMENTS:

- Minimum: 26 1/2"W Cabinet Opening (27 3/4"W or 28"W cabinet depending on Interior Finish).
- 2 5/8"D clearance in front of sink or appliance.

TILT OUT SOAP TRAY SS 26.5W



DESCRIPTION:

- 31"W x 2 1/8"D Stainless Steel Tray.

SIZE REQUIREMENTS:

- Minimum: 32 1/2"W Cabinet Opening (33 3/4"W or 34"W cabinet depending on Interior Finish).
- 2 5/8"D clearance in front of sink or appliance.

TILT OUT SOAP TRAY SS 32.5W



DESCRIPTION:

- 28"W x 2 1/8"D Stainless Steel Tray.

SIZE REQUIREMENTS:

- Minimum: 29 1/2"W Cabinet Opening (30 3/4"W or 31"W cabinet depending on Interior Finish).
- 2 5/8"D clearance in front of sink or appliance.

TILT OUT SOAP TRAY SS 29.5W

MISCELLANEOUS ACCESSORIES:



SPECIFICATIONS:

DESCRIPTION:

- Heavy Duty Mixer Lift-Up Shelf with Soft-Close.
- Shelf matches Interior Finish.

CABINET REQUIREMENTS:

- Designed to fit in a FDB.

SIZE REQUIREMENTS:

- 13 1/2"W to 21"W.
- Minimum 27"H door.
- Maximum weight capacity: 60 lbs.

CONSIDERATIONS:

- Subject to Möbel approval.

MIXER-LIFT-UP SHELF



SPECIFICATIONS:

DESCRIPTION:

- Add a Chrome Finished Closet Rod to a cabinet.
- 1 5/16" Diametre.
- Default location is 3" from Cabinet Top or Fixed Shelf & 12" from inside back.

CONSIDERATIONS:

- Please confirm if adjustable shelves are still required.
- Base Depth cabinets are recommended.
- Subject to Möbel approval.

CLOSETROD



SPECIFICATIONS:

DESCRIPTION:

- Vauth Sagel ENVI Toe Kick Opener.
- Designed to work with VS ENVI waste bin cabinets but may work with other hardware as well.

CONSIDERATIONS:

- Available shipped loose only.

VS ENVI TK LOOSE